



Owner's Manual

For your safety and comfort, read carefully and keep in the vehicle.

COROLLA HYBRID



©2022 TOYOTA MOTOR CORPORATION

All rights reserved. This material may not be reproduced or copied, in whole or in part, without the written permission of Toyota Motor Corporation.

Pictorial index

Search by illustration

For safety and security

Make sure to read through them
(Main topics: Child seat, theft deterrent system)

1

Vehicle status information and indicators

Reading driving-related information
(Main topics: Meters, multi-information display)

2

Before driving

Opening and closing the doors and windows, adjustment before driving
(Main topics: Keys, doors, seats, power windows)

3

Driving

Operations and advice which are necessary for driving
(Main topics: Starting hybrid system, refueling)

4

Interior features

Usage of the interior features
(Main topics: Air conditioner, storage features)

5

Maintenance and care

Caring for your vehicle and maintenance procedures
(Main topics: Interior and exterior, light bulbs)

6

When trouble arises

What to do in case of malfunction and emergency
(Main topics: 12-volt battery discharge, flat tire)

7

Vehicle specifications

Vehicle specifications, customizable features
(Main topics: Fuel, oil, tire inflation pressure)

8

Index

Search by symptom

Search alphabetically

For your information	5
Reading this manual.....	10
How to search	11
Pictorial index	12

1 For safety and security

1-1. For safe use	
Before driving.....	22
For safe driving.....	23
Seat belts.....	25
SRS airbags.....	29
Exhaust gas precautions	36
1-2. Child safety	
Riding with children.....	38
Child restraint systems	39
1-3. Emergency assistance	
Toyota Connected Services ..	54
1-4. Hybrid system	
Hybrid system features	58
Hybrid system precautions ...	61
1-5. Theft deterrent system	
Immobilizer system	66

2 Vehicle status information and indicators

2-1. Instrument cluster	
Warning lights and indicators	68
Gauges and meters (7-inch display).....	72
Gauges and meters (12.3-inch display)	75
Multi-information display (7-inch display)	80
Multi-information display (12.3-inch display)	86

Head-up display.....	93
Energy monitor/consumption screen.....	97

3 Before driving

3-1. Key information	
Keys.....	102
3-2. Opening, closing and locking the doors	
Doors	105
Trunk.....	109
Smart entry & start system	111
3-3. Adjusting the seats	
Front seats.....	116
Rear seats	117
Head restraints	119
3-4. Adjusting the steering wheel and mirrors	
Steering wheel.....	121
Inside rear view mirror	122
Outside rear view mirrors....	123
3-5. Opening and closing the windows	
Power windows.....	125
Moon roof.....	127
3-6. Favorite settings	
My Settings	130

4 Driving

4-1. Before driving	
Driving the vehicle	132
Cargo and luggage	138
Trailer towing	139

4-2. Driving procedures
 Power (ignition) switch **140**
 EV drive mode **144**
 Hybrid transmission **146**
 Turn signal lever **148**
 Parking brake..... **149**
 Brake Hold **152**

4-3. Operating the lights and wipers
 Headlight switch..... **154**
 AHB (Automatic High Beam)
 **156**
 Fog light switch **159**
 Windshield wipers and washer
 **160**

4-4. Refueling
 Opening the fuel tank cap... **163**

4-5. Using the driving support systems
 Toyota Safety Sense **165**
 PCS (Pre-Collision System)
 **171**
 LTA (Lane Tracing Assist) ... **181**
 LDA (Lane Departure Alert)
 **186**
 Emergency Driving Stop System
 **191**
 RSA (Road Sign Assist) **193**
 Dynamic radar cruise control
 **195**
 Cruise control..... **204**
 BSM (Blind Spot Monitor) ... **206**
 RCTA (Rear Cross Traffic Alert)
 function **211**
 Safe Exit Assist **216**
 Driving mode select switch
 **220**
 Driving assist systems **221**

4-6. Driving tips
 Hybrid vehicle driving tips ... **226**
 Winter driving tips **228**

5 Interior features

5-1. Using the air conditioning system and defogger
 Automatic air conditioning system..... **232**
 Seat heaters **236**

5-2. Using the interior lights
 Interior lights list..... **238**

5-3. Using the storage features
 List of storage features **240**

5-4. Other interior features
 Other interior features..... **244**

6 Maintenance and care

6-1. Maintenance and care
 Cleaning and protecting the vehicle exterior **254**
 Cleaning and protecting the vehicle interior **257**

6-2. Maintenance
 Maintenance requirements
 **260**

6-3. Do-it-yourself maintenance
 Do-it-yourself service precautions **262**
 Hood **264**
 Positioning a floor jack..... **265**
 Engine compartment..... **266**
 Tires **272**
 Tire inflation pressure **274**
 Wheels..... **275**

1

2

3

4

5

6

7

8

Air conditioning filter	276
Cleaning the hybrid battery (traction battery) air intake vents	278
Electronic key battery	281
Checking and replacing fuses	283
Light bulbs	285

7 When trouble arises

7-1. Essential information

Emergency flashers	290
If your vehicle has to be stopped in an emergency	290
If the vehicle is submerged or water on the road is rising	291

7-2. Steps to take in an emergency

If your vehicle needs to be towed	293
If you think something is wrong	296
If a warning light turns on or a warning buzzer sounds.....	298
If a warning message is displayed	305
If you have a flat tire (vehicles without spare tire)	309
If you have a flat tire (vehicles with a spare tire)	319
If the hybrid system will not start	326
If you lose your keys	327
If the electronic key does not operate properly	328
If the 12-volt battery is discharged.....	330

If your vehicle overheats.....	333
If the vehicle becomes stuck	336

8 Vehicle specifications

8-1. Specifications

Maintenance data (fuel, oil level, etc.).....	338
Fuel information	345

8-2. Customization

Customizable features	346
-----------------------------	------------

Index

What to do if... (Troubleshooting)	358
Alphabetical Index	361

For your information

Main Owner's Manual

Please note that this manual applies to all models and explains all equipment, including options. Therefore, you may find some explanations for equipment not installed on your vehicle.

All specifications provided in this manual are current at the time of printing. However, because of the Toyota policy of continual product improvement, we reserve the right to make changes at any time without notice.

Depending on specifications, the vehicle shown in the illustrations may differ from your vehicle in terms of equipment.

Accessories, spare parts and modification of your Toyota

A wide variety of non-genuine spare parts and accessories for Toyota vehicles are currently available in the market. Using these spare parts and accessories which are not genuine Toyota products may adversely affect the safety of your vehicle, even though these parts may be approved by certain authorities in your country. Toyota Motor Corporation therefore cannot accept any liability or guarantee spare parts and accessories which

are not genuine Toyota products, nor for replacement or installation involving such parts.

This vehicle should not be modified with non-genuine Toyota products. Modification with non-genuine Toyota products could affect its performance, safety or durability, and may even violate governmental regulations. In addition, damage or performance problems resulting from the modification may not be covered under warranty.

Also, remodeling like this will have an effect on advanced safety equipment such as Toyota Safety Sense and there is a danger that it will not work properly or the danger that it may work in situations where it should not be working.

Cyber Attack Risk

Installing electronic devices and radios increases the risk of cyber attacks through the installed parts, which may lead to unexpected accidents and leakage of personal information. Toyota does not make any guarantees for problems caused by installing non-genuine Toyota products.

Installation of an RF-transmitter system

The installation of an RF-transmitter system in your vehicle could affect electronic systems such as:

- Multiport fuel injection system/sequential multiport fuel injection system
- Toyota Safety Sense
- Anti-lock brake system
- SRS airbag system
- Seat belt pretensioner system

Be sure to check with your Toyota dealer for precautionary measures or special instructions regarding installation of an RF-transmitter system.

Further information regarding frequency bands, power levels, antenna positions and installation provisions for the installation of RF-transmitters, is available on request at your Toyota dealer.

High voltage parts and cables on the hybrid vehicles emit approximately the same amount of electromagnetic waves as the conventional gasoline powered vehicles or home electronic appliances despite of their electromagnetic shielding.

Unwanted noise may occur in the reception of the radio frequency transmitter (RF-transmitter).

Vehicle data recording

This vehicle is equipped with sophisticated computers that record certain data regarding vehicle controls and operations.

- Data recorded by the computers

Certain data, such as the following, is recorded depending on the operation timing and status of each function.

- Engine speed/Electric motor speed (traction motor speed)
- Accelerator status
- Brake status
- Vehicle speed
- Operation status of the driving assist systems
- Images from the cameras

Your vehicle is equipped with cameras. Contact your Toyota dealer for the location of recording cameras.

The recorded data varies according to the vehicle grade level and options with which it is equipped.

These computers do not record conversations or sounds, and only record images outside of the vehicle in certain situations.

- Data usage

Toyota may use the data recorded in this computer to diagnose malfunctions, conduct research and development, and improve quality.

Toyota will not disclose the recorded data to a third party except:

- With the consent of the vehicle owner or with the consent of the lessee if the vehicle is leased
- In response to an official request by the police, a court of law or a government agency
- For use by Toyota in a lawsuit
- For research purposes where the data is not tied to a specific vehicle or vehicle owner

Image information recorded by the vehicle can be erased by your Toyota dealer.

The image recording function can be disabled. However, if the function is disabled, data from when systems operate will not be available.

If you wish to stop the collection of Toyota Safety Sense data by the Toyota servers for the purpose of research and development and provision to individual services, contact your Toyota dealer.

Usage of data collected through Toyota Connected Services

If your Toyota has Toyota Connect and if you have subscribed to those services, please refer to the Toyota Connect usage contract for information on data collected and its usage.

For more information, visit <https://www.toyota.com.au/privacy>.

Event data recorder

This vehicle is equipped with an event data recorder (EDR). The main purpose of an EDR is to record, in certain crash or near crash-like situations, such as an airbag deployment or hitting a road obstacle, data that will assist in understanding how a vehicle's systems performed. The EDR is designed to record data related to vehicle dynamics and safety systems for a short period of time, typically 30 seconds or less. However, data may not be recorded depending on the severity and type of a crash.

The EDR in this vehicle is designed to record such data as:

- How various systems in your vehicle were operating;
- How far (if at all) the driver was depressing the accelerator and/or brake pedal; and,
- How fast the vehicle was traveling.

These data can help provide a better understanding of the circumstances in which crashes and injuries occur.

NOTE: EDR data are recorded by your vehicle only if a nontrivial crash situation occurs; no data are recorded by the EDR under normal driving conditions and no personal data (e.g., name, gender, age, and crash location) are recorded. However, other parties, such as law enforcement, could combine the EDR data with the type of personally identifying data routinely acquired during a crash investigation.

To read data recorded by an EDR, special equipment is required, and access to the vehicle or the EDR is needed. In addition to the vehicle manufacturer, other parties, such as law enforcement, that have the special equipment, can read the information if they have access to the vehicle or the EDR.

● Disclosure of the EDR data

Toyota will not disclose the data recorded in an EDR to a third party

except when:

- An agreement from the vehicle's owner (or the lessee for a leased vehicle) is obtained
- In response to an official request by the police, a court of law or a government agency
- For use by Toyota in a lawsuit

However, if necessary, Toyota may:

- Use the data for research on vehicle safety performance
- Disclose the data to a third party for research purposes without disclosing information about the specific vehicle or vehicle owner

Scraping of your Toyota

The SRS airbag and seat belt pretensioner devices in your Toyota contain explosive chemicals. If the vehicle is scrapped with the airbags and seat belt pretensioners left as they are, this may cause an accident such as fire. Be sure to have the systems of the SRS airbag and seat belt pretensioner removed and disposed of by a qualified service shop or by your Toyota dealer before you scrap your vehicle.

“QR Code”

The word “QR Code” is registered trademark of DENSO WAVE INCORPORATED in Japan and other countries.



WARNING

■ General precautions while driving

Driving under the influence: Never drive your vehicle when under the influence of alcohol or drugs that have impaired your ability to operate your vehicle. Alcohol and certain drugs delay reaction time, impair judgment and reduce coordination, which could lead to an accident that could result in death or serious injury.

Defensive driving: Always drive defensively. Anticipate mistakes that other drivers or pedestrians might make and be ready to avoid accidents.

Driver distraction: Always give your full attention to driving. Anything that distracts the driver, such as adjusting controls, talking on a cellular phone or reading can result in a collision with resulting death or serious injury to you, your occupants or others.

■ General precaution regarding children's safety

Never leave children unattended in the vehicle, and never allow children to have or use the key.

Children may be able to start the vehicle or shift the vehicle into neutral. There is also a danger that children may injure themselves by playing with the windows, the moon roof, or other features of the vehicle. In addition, heat build-up or extremely cold temperatures inside the vehicle can be fatal to children.

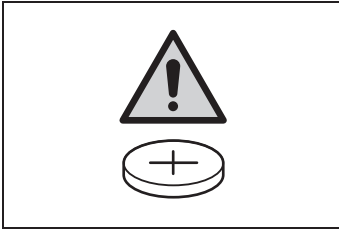
**WARNING****■ General precaution regarding a coin battery and button battery**



This product contains a coin battery or button battery. Observe the following precautions. Failure to do so may result in death or serious injury.

- Keep away new and removed batteries from children.
- Do not swallow the battery. Doing so may cause chemical burns.
- If a battery is swallowed, it may cause severe chemical burns in as little as 2 hours and may result in death or serious injury.
- If you accidentally swallow a battery or put a battery into a part of your body, get emergency medical attention immediately.

Reading this manual



Explains symbols used in this manual.

Symbols in this manual

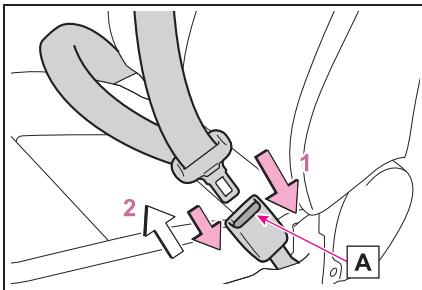

Symbols	Meanings
	WARNING: Explains something that, if not obeyed, could cause death or serious injury to people.
	NOTICE: Explains something that, if not obeyed, could cause damage to or a malfunction in the vehicle or its equipment.
1 2 3...	Indicates operating or working procedures. Follow the steps in numerical order.

Symbols in illustrations

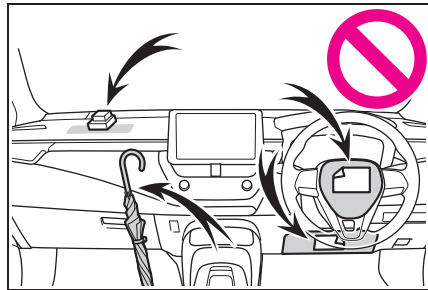

Symbols	Meanings
	Indicates the action (pushing, turning, etc.) used to operate switches and other devices.
	Indicates the outcome of an operation (e.g. a lid opens).



Symbols	Meanings
	Indicates the component or position being explained.
	Means Do not, Do not do this, or Do not let this happen.

How to search

■ Searching by name

- Alphabetical index: →P.361

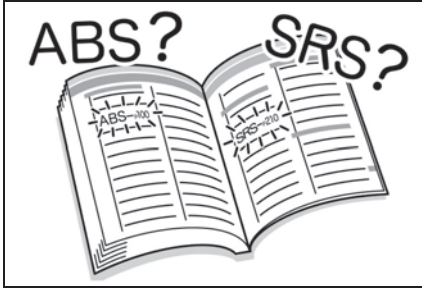

■ Searching by installation position

- Pictorial index: →P.12

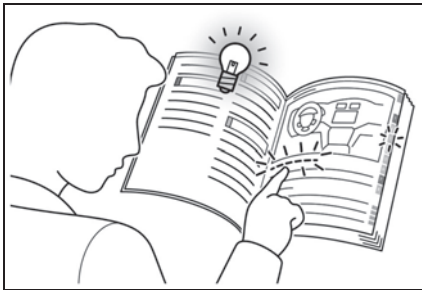

■ Searching by symptom or sound

- What to do if... (Troubleshooting): →P.358



■ Searching by title

- Table of contents: →P.2

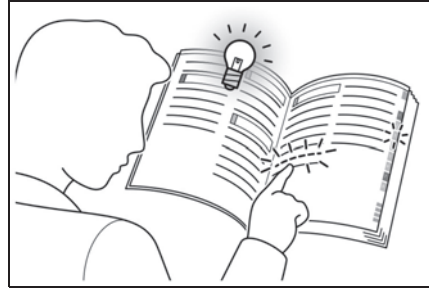

Pictorial index

■ Exterior

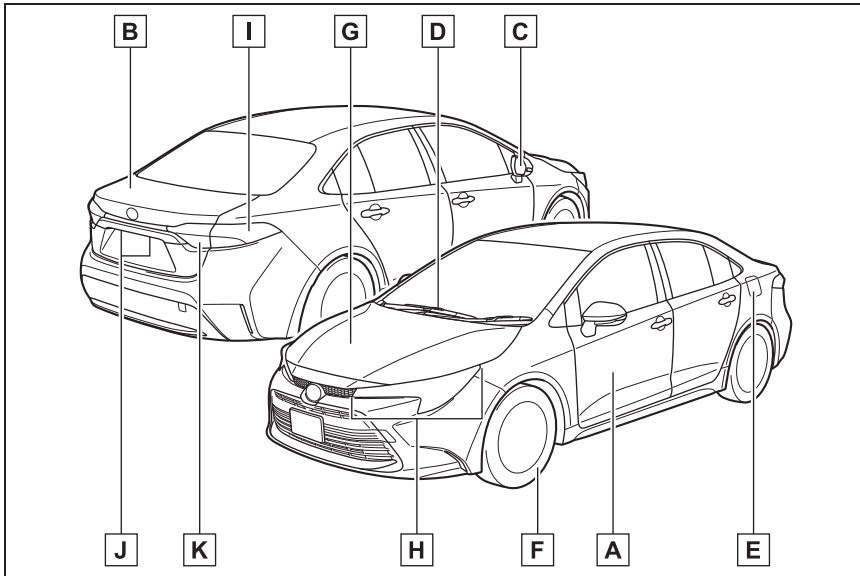

A	Doors	P.105
	Locking/unlocking	P.105
	Opening/closing the side windows.....	P.125
	Locking/unlocking by using the mechanical key	P.328
	Warning messages	P.108
B	Trunk	P.109
	Opening from inside.....	P.110
	Opening from outside.....	P.110
	Warning messages	P.111
C	Outside rear view mirrors	P.123
	Adjusting the mirror angle	P.124
	Folding the mirrors	P.124
	Defogging the mirrors	P.233
D	Windshield wipers	P.160
	Precautions for winter season.....	P.228
E	Fuel filler door	P.163

	Refueling method	P.164
	Fuel type/fuel tank capacity	P.339
F	Tires	P.272
	Tire size/inflation pressure	P.343
	Winter tires/tire chains	P.228
	Checking/rotation	P.272
	Coping with flat tires.....	P.309, 319
G	Hood.....	P.264
	Opening	P.264
	Engine oil	P.339
	Coping with overheating	P.333

Light bulbs of the exterior lights for driving

(Replacing method: P.285, Watts: P.344)

H	Headlights/daytime running lights/front position lights/turn signal lights	P.148, 154
I	Stop lights/tail lights/turn signal lights.....	P.148, 154
J	License plate lights.....	P.154
K	Rear fog light.....	P.159
	Back-up light	
	Shifting the shift position to R	P.146

■ Instrument panel

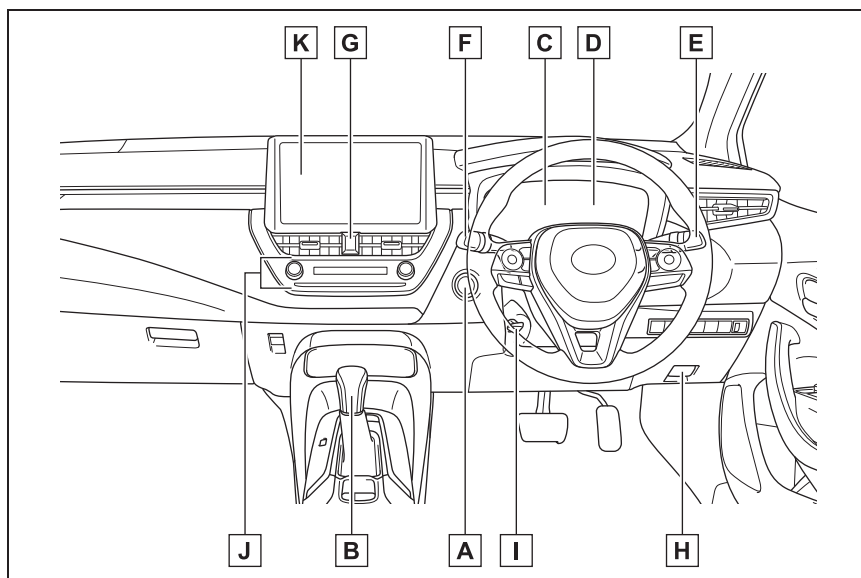

- A Power switch**P.140
 Starting the hybrid system/changing the modesP.140
 Emergency stop of the hybrid systemP.290
 When the hybrid system will not startP.326
 Warning messagesP.305
- B Shift lever**.....P.146
 Changing the shift position.....P.146
 Precautions for towingP.293
 When the shift lever does not move.....P.147
- C Meters**P.72, 75
 Reading the meters/adjusting the instrument panel lightP.72, 75
 Warning lights/indicator lightsP.68
 When a warning light turns onP.298
- D Multi-information display**P.80, 86
 DisplayP.80, 86
 Energy monitor.....P.97

	When a warning message is displayed.....	P.305
E	Turn signal lever	P.148
	Headlight switch	P.154
	Headlights/front position lights/tail lights/license plate lights/daytime running lights.....	P.154
	Rear fog light.....	P.159
F	Windshield wiper and washer switch	P.160
	Usage.....	P.160
	Adding washer fluid.....	P.271
G	Emergency flasher switch.....	P.290
H	Hood lock release lever	P.264
I	Tilt and telescopic steering lock release lever.....	P.121
J	Air conditioning system	P.232
	Usage.....	P.232
	Rear window defogger	P.233
K	Audio system *	

*: Refer to "Multimedia Owner's Manual".

■ Switches

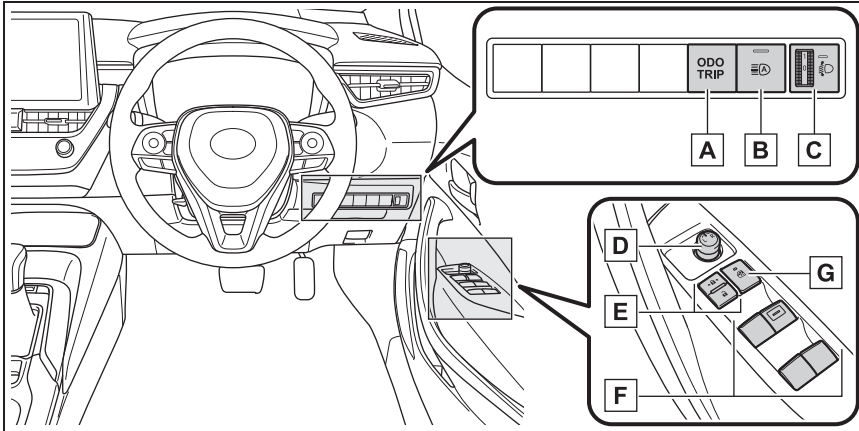

- A** ODO TRIP switch*P.79
- B** Automatic High Beam switchP.156
- C** Headlight leveling dialP.155
- D** Outside rear view mirror switchP.123
- E** Door lock switchesP.108
- F** Power window switches.....P.125
- G** Window lock switch.....P.127

*: If equipped

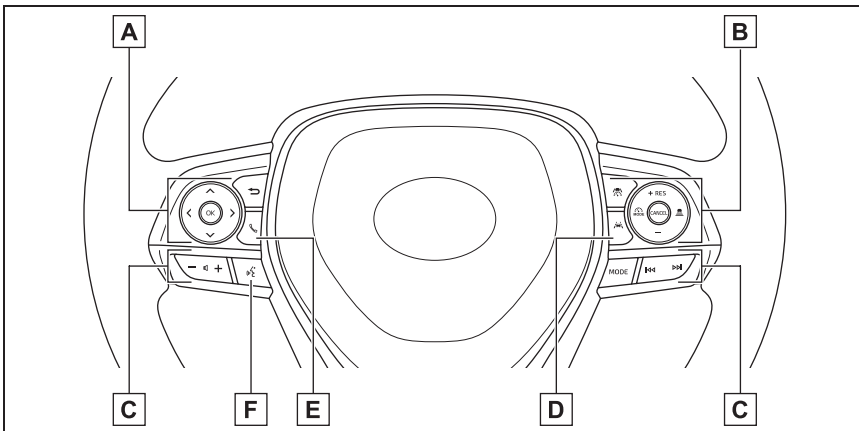

- A** Meter control switchesP.81, 87

B Cruise control switches

Dynamic radar cruise controlP.195

Cruise control.....P.204

C Audio remote control switches*

D LTA (Lane Tracing Assist) switchP.181

E Phone switch*

F Talk switch*

*: Refer to "Multimedia Owner's Manual".

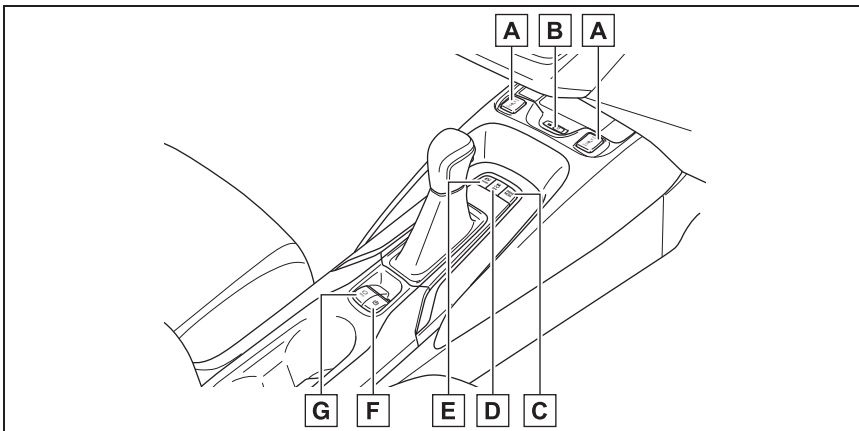

A Seat heater switches*P.236

B Wireless charger switch*P.245

C Driving mode select switch.....P.220

D VSC OFF switchP.222

E EV drive mode switch.....P.144

F Parking brake switchP.149

Applying/releasing.....P.149

Precautions against winter seasonP.229

Warning buzzer/messageP.298, 305

G Brake hold switchP.152

*: If equipped

■ Interior

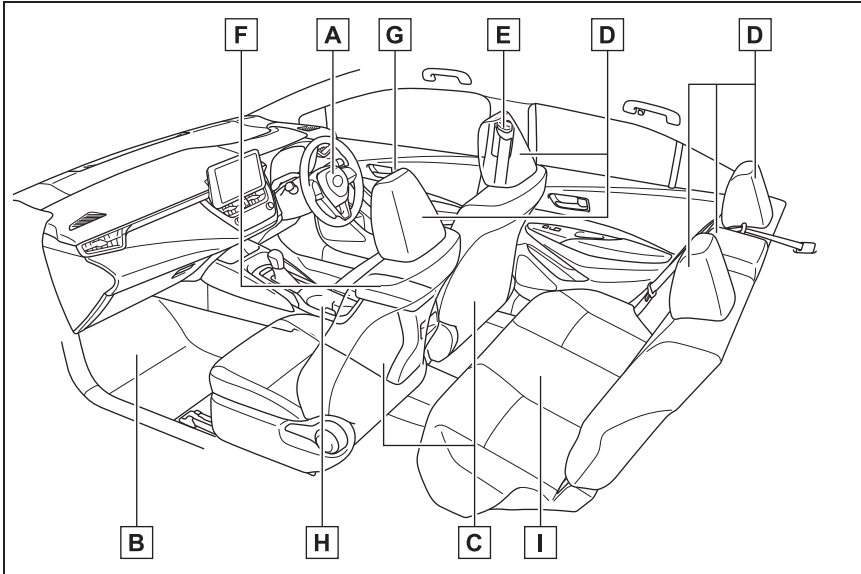

A	SRS airbags	P.29
B	Floor mats	P.22
C	Front seats	P.116
D	Head restraints	P.119
E	Seat belts	P.25
F	Console box	P.242
G	Inside lock buttons	P.108
H	Cup holders	P.241
I	Rear seats	P.117

■ Ceiling

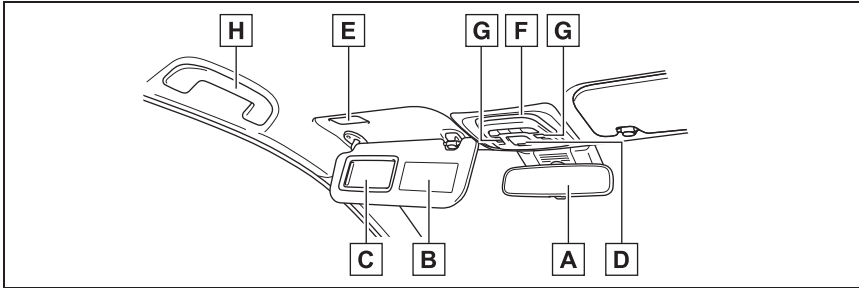

- A** Inside rear view mirrorP.122
- B** Sun visors*¹P.251
- C** Vanity mirrorsP.251
- D** “SOS” button*²P.54
- E** Vanity lightsP.251
- F** Interior lights/personal lightsP.238
- G** Moon roof switches*²P.127
- H** Assist gripsP.252

*¹: NEVER use a rearward facing child restraint on a seat protected by an ACTIVE AIRBAG in front of it, DEATH or SERIOUS INJURY to the CHILD can occur. (→P.41)



*²: If equipped

For safety and security

1

1-1. For safe use	
Before driving	22
For safe driving	23
Seat belts	25
SRS airbags	29
Exhaust gas precautions	36
1-2. Child safety	
Riding with children	38
Child restraint systems	39
1-3. Emergency assistance	
Toyota Connected Services.....	54
1-4. Hybrid system	
Hybrid system features	58
Hybrid system precautions	61
1-5. Theft deterrent system	
Immobilizer system	66

Before driving

Observe the following before starting off in the vehicle to ensure safety of driving.

Floor mat

Use only floor mats designed specifically for vehicles of the same model and model year as your vehicle. Fix them securely in place onto the carpet.

- 1 Insert the retaining hooks (clips) into the floor mat eyelets.

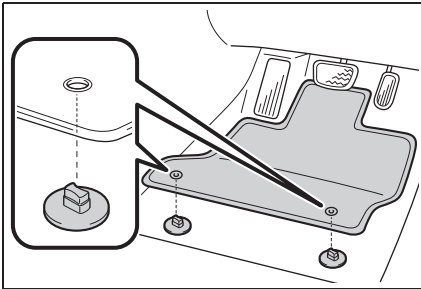

- 2 Turn the upper knob of each retaining hook (clip) to secure the floor mats in place.

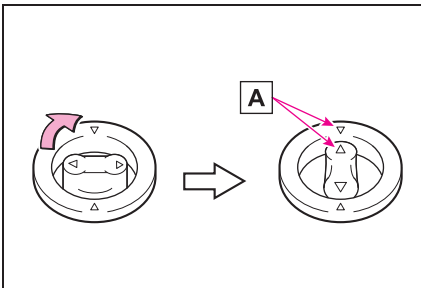

Always align the \triangle marks **A**.

The shape of the retaining hooks (clips)

may differ from that shown in the illustration.

WARNING

Observe the following precautions. Failure to do so may cause the driver's floor mat to slip, possibly interfering with the pedals while driving. An unexpectedly high speed may result or it may become difficult to stop the vehicle. This could lead to an accident, resulting in death or serious injury.

■ When installing the driver's floor mat

- Do not use floor mats designed for other models or different model year vehicles, even if they are Toyota Genuine floor mats.
- Only use floor mats designed for the driver's seat.
- Always install the floor mat securely using the retaining hooks (clips) provided.
- Do not use two or more floor mats on top of each other.
- Do not place the floor mat bottom-side up or upside-down.

■ Before driving

- Check that the floor mat is securely fixed in the correct place with all the provided retaining hooks (clips). Be especially careful to perform this check after cleaning the floor.

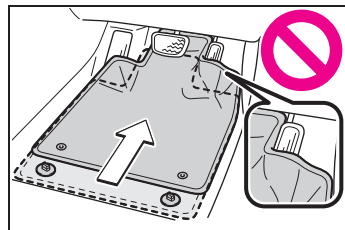

**WARNING**

- With the hybrid system stopped and the shift lever in P, fully depress each pedal to the floor to make sure it does not interfere with the floor mat.

For safe driving

For safe driving, adjust the seat and mirror to an appropriate position before driving.

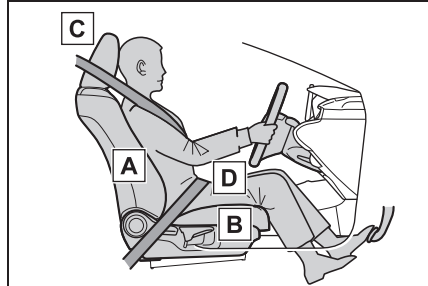
Correct driving posture

- A** Adjust the angle of the seatback so that you are sitting straight up and so that you do not have to lean forward to steer. (→P.116)
- B** Adjust the seat so that you can depress the pedals fully and so that your arms bend slightly at the elbow when gripping the steering wheel. (→P.116)
- C** Lock the head restraint in place with the center of the head restraint closest to the top of your ears. (→P.119)
- D** Wear the seat belt correctly. (→P.25)

**WARNING****For safe driving**

Observe the following precautions. Failure to do so may result in death or serious injury.



WARNING

- Do not adjust the position of the driver's seat while driving. Doing so could cause the driver to lose control of the vehicle.
- Do not place a cushion between the driver or passenger and the seatback.
A cushion may prevent correct posture from being achieved, and reduce the effectiveness of the seat belt and head restraint.
- Do not place anything under the front seats.
Objects placed under the front seats may become jammed in the seat tracks and stop the seat from locking in place. This may lead to an accident and the adjustment mechanism may also be damaged.
- Always observe the legal speed limit when driving on public roads.
- When driving over long distances, take regular breaks before you start to feel tired.
Also, if you feel tired or sleepy while driving, do not force yourself to continue driving and take a break immediately.
- Take care when adjusting the seat position to ensure that other passengers are not injured by the moving seat.
- When adjusting the seat position, do not put your hands under the seat or near the moving parts to avoid injury. Fingers or hands may become jammed in the seat mechanism.

Use a child restraint system appropriate for the child until the child becomes large enough to properly wear the vehicle's seat belt. (→P.39)

Adjusting the mirrors

Make sure that you can see backward clearly by adjusting the inside and outside rear view mirrors properly. (→P.122, 123)

Correct use of the seat belts

Make sure that all occupants are wearing their seat belts before driving the vehicle. (→P.25)

Seat belts

Make sure that all occupants are wearing their seat belts before driving the vehicle.



WARNING

Observe the following precautions to reduce the risk of injury in the event of sudden braking, sudden swerving or an accident.

Failure to do so may cause death or serious injury.

■ Wearing a seat belt

- Ensure that all passengers wear a seat belt.
- Always wear a seat belt properly.
- Each seat belt should be used by one person only. Do not use a seat belt for more than one person at once, including children.
- Toyota recommends that children be seated in the rear seat and always use a seat belt and/or an appropriate child restraint system.
- To achieve a proper seating position, do not recline the seat more than necessary. The seat belt is most effective when the occupants are sitting up straight and well back in the seats.
- Do not wear the shoulder belt under your arm.
- Always wear your seat belt low and snug across your hips.

■ Pregnant women

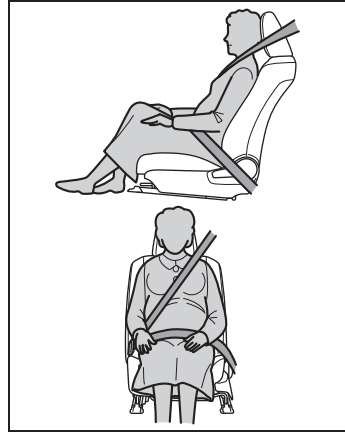

Obtain medical advice and wear the seat belt in the proper way. (→P.26)

Women who are pregnant should position the lap belt as low as possible over the hips in the same manner as other occupants, extending the shoulder belt completely over the shoulder and avoiding belt contact with the rounding of the abdominal area.

If the seat belt is not worn properly, not only the pregnant woman, but also the fetus could suffer death or serious injury as a result of sudden braking or a collision.

■ People suffering illness

Obtain medical advice and wear the seat belt in the proper way. (→P.26)

■ When children are in the vehicle

→P.39

■ Seat belt damage and wear

- Do not damage the seat belts by allowing the belt, plate, or buckle to be jammed in the door.



WARNING

- Inspect the seat belt system periodically. Check for cuts, fraying, and loose parts. Do not use a damaged seat belt until it is replaced. Damaged seat belts cannot protect an occupant from death or serious injury.
- Ensure that the belt and plate are locked and the belt is not twisted.
- If the seat belt does not function correctly, immediately contact your Toyota dealer.
- Replace the seat assembly, including the belts, if your vehicle has been involved in a serious accident, even if there is no obvious damage.
- Do not attempt to install, remove, modify, disassemble or dispose of the seat belts. Have any necessary repairs carried out by your Toyota dealer. Inappropriate handling may lead to incorrect operation.

Correct use of the seat belts

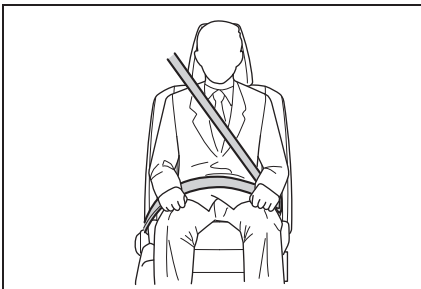

- Extend the shoulder belt so that it comes fully over the shoulder, but does not come into contact with the neck or slide off the shoulder.
- Position the lap belt as low as possible over the hips.
- Adjust the position of the

seatback. Sit up straight and well back in the seat.

- Do not twist the seat belt.

Child seat belt usage

The seat belts of your vehicle were principally designed for persons of adult size.

- Use a child restraint system appropriate for the child, until the child becomes large enough to properly wear the vehicle's seat belt. (→P.39)
- When the child becomes large enough to properly wear the vehicle's seat belt, follow the instructions regarding seat belt usage. (→P.25)

Seat belt regulations

If seat belt regulations exist in the country where you reside, please contact your Toyota dealer for seat belt replacement or installation.

Fastening and releasing the seat belt

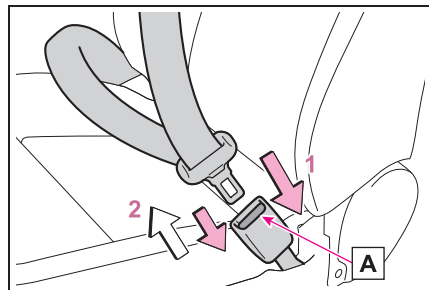

- 1 To fasten the seat belt, push the plate into the buckle until a click sound is heard.
- 2 To release the seat belt, press the release button **A**.

Emergency locking retractor (ELR)

The retractor will lock the belt during a sudden stop or on impact. It may also

lock if you lean forward too quickly. A slow, easy motion will allow the belt to extend so that you can move around fully.

■ Rear seat belt

Use the seat belt after passing it through the guide if the seat belt comes free from the guide.

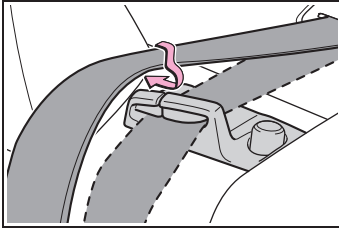

Adjusting the seat belt shoulder anchor height (front seats)

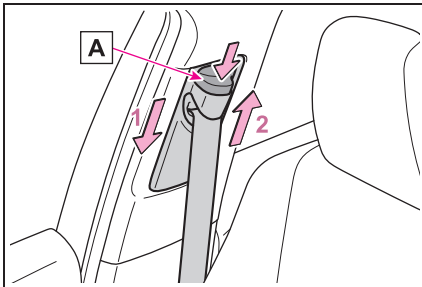

- 1 Push the seat belt shoulder anchor down while pressing the release button **A**.
- 2 Push the seat belt shoulder anchor up while pressing the release button **A**.

Move the height adjuster up and down as needed until you hear a click.

⚠ WARNING

■ Adjustable shoulder anchor

Always make sure the shoulder belt is positioned across the center of your shoulder. The belt should be kept away from your neck, but not falling off your shoulder. Failure to do so could reduce the amount of protection in an accident and cause death or serious injuries in the event of a sudden stop, sudden swerve or accident.

Seat belt pretensioners (front and outboard rear seats)

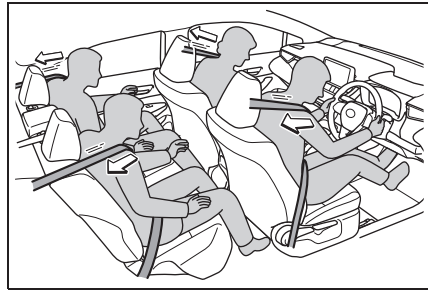

The pretensioners help the seat belts to quickly restrain the occupants by retracting the seat belts when the vehicle is subjected to certain types of severe frontal or side collision.

The pretensioners do not activate in the event of a minor frontal impact, a minor side impact, a rear impact or a vehicle rollover.

■ PCS-linked seat belt pretensioner control

If the PCS (Pre-Collision System) determines that the possibility of a collision with a vehicle is high, the seat belt

pretensioners will be prepared to operate.

■ **Replacing the belt after the pretensioner has been activated**

If the vehicle is involved in multiple collisions, the pretensioner will activate for the first collision, but will not activate for the second or subsequent collisions.



WARNING

■ **Seat belt pretensioners**

If a pretensioner has operated, the SRS warning light will illuminate. In this situation, the seat belt cannot be used and must be replaced by your Toyota dealer. Failure to do so may result in death or serious injury.

SRS airbags

The SRS airbags inflate when the vehicle is subjected to certain types of severe impacts that may cause significant injury to the occupants. They work together with the seat belts to help reduce the risk of death or serious injury.

SRS airbag system

■ Location of the SRS airbags

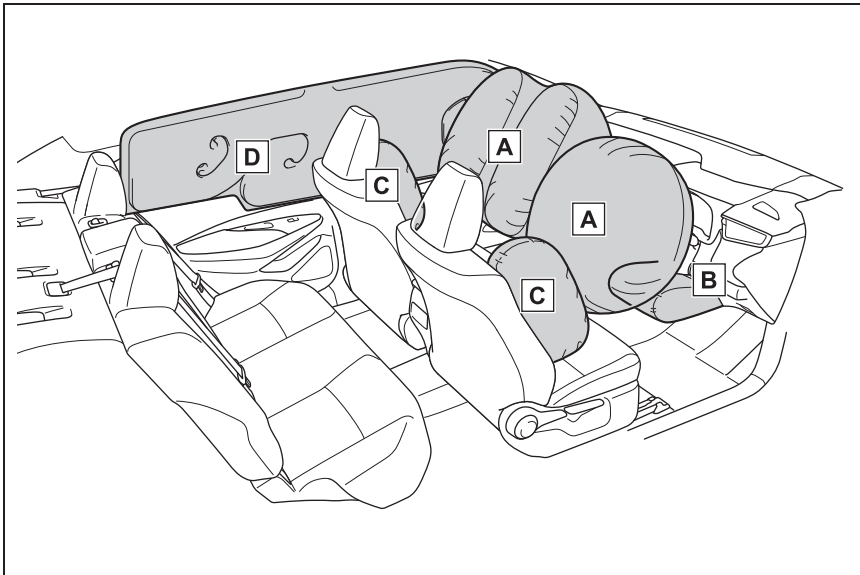

► SRS front airbags

A SRS driver airbag/front passenger airbag

Can help protect the head and chest of the driver and front passenger from impact with interior components

B SRS knee airbag

Can help provide driver protection

► SRS side and curtain shield airbags

C SRS front side airbags

Can help protect the torso of the front seat occupants

D SRS curtain shield airbags

Can help protect primarily the head of occupants in the outer seats

■ SRS airbag system components

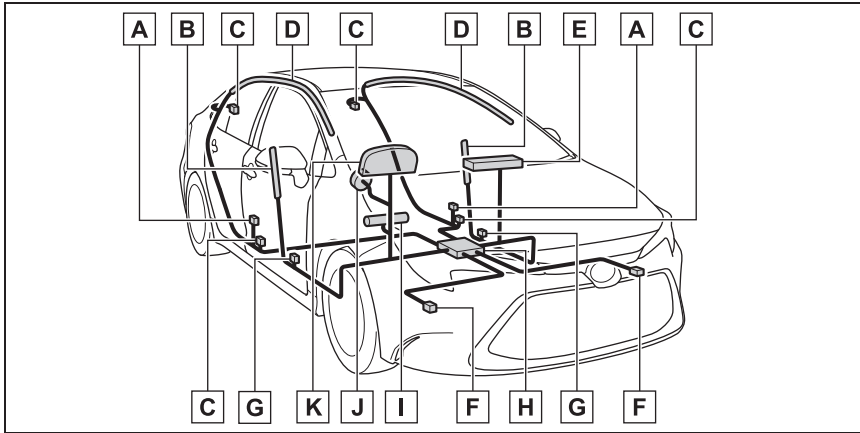

- A** Side impact sensors (front)
- B** Side airbags
- C** Seat belt pretensioners and force limiters
- D** Curtain shield airbags
- E** Front passenger airbag
- F** Front impact sensors
- G** Side impact sensors (front door)
- H** Airbag sensor assembly
- I** Driver's knee airbag
- J** Driver airbag
- K** SRS warning light

The main SRS airbag system components are shown above. The SRS airbag system is controlled by the airbag sensor assembly. As the airbags deploy, a chemical reaction in the inflators quickly fills the airbags with non-toxic gas to help restrain the motion of the occupants.

■ If the SRS airbags deploy (inflate)

- Slight abrasions, burns, bruising etc., may be sustained from SRS airbags, due to the extremely high speed deployment (inflation) by hot gases.
- A loud noise and white powder will be emitted.
- Parts of the airbag module (steering wheel hub, airbag cover and inflator) as well as the front seats, parts of the front and rear pillars, and roof side

rails, may be hot for several minutes. The airbag itself may also be hot.

- The windshield may crack.
- The hybrid system will be stopped and fuel supply to the engine will be stopped. (→P.64)
- The brakes and stop lights will be controlled automatically. (→P.222)
- The interior lights will turn on automatically. (→P.239)
- The emergency flashers will turn on automatically. (→P.290)
- For Toyota Connected Services, if any of the following situations occur, the system is designed to send an emergency call to the response center, notifying them of the vehicle's location (without needing to push the "SOS" button) and an agent will attempt to speak with the occupants to ascertain the level of emergency and assistance required. If the occupants are unable to communicate, the agent automatically treats the call as an emergency and helps to dispatch the necessary emergency services. (→P.54)
 - An SRS airbag is deployed.
 - A seat belt pretensioner is activated.
 - The vehicle is involved in a severe rear-end collision.

■ SRS airbag deployment conditions (SRS front airbags)

- The SRS front airbags will deploy in the event of an impact that exceeds the set threshold level (the level of force corresponding to an approximately 20 - 30 km/h [12 - 18 mph] frontal collision with a fixed wall that does not move or deform).

However, this threshold velocity will be considerably higher in the following situations:

- If the vehicle strikes an object, such as a parked vehicle or sign pole, which can move or deform on impact
- If the vehicle is involved in an underride collision, such as a collision in which the front of the vehicle "underrides", or goes under, the bed

of a truck

- Depending on the type of collision, it is possible that only the seat belt pretensioners will activate.

■ SRS airbag deployment conditions (SRS side and curtain shield airbags)

- The SRS side and curtain shield airbags will deploy in the event of an impact that exceeds the set threshold level (the level of force corresponding to the impact force produced by an approximately 1500 kg [3300 lb.] vehicle colliding with the vehicle cabin from a direction perpendicular to the vehicle orientation at an approximate speed of 20 - 30 km/h [12 - 18 mph]).
- Both SRS curtain shield airbags will deploy in the event of a side collision on either side.
- Both SRS curtain shield airbags will deploy in the event of a severe frontal collision.

■ Conditions under which the SRS airbags may deploy (inflate), other than a collision

The SRS front airbags and SRS side and curtain shield airbags may also deploy if a serious impact occurs to the underside of your vehicle. Some examples are shown in the illustration.

- Hitting a curb, edge of pavement or hard surface
- Falling into or jumping over a deep hole
- Landing hard or falling

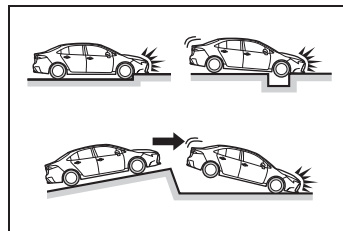

■ **Types of collisions that may not deploy the SRS airbags (SRS front airbags)**

The SRS front airbags do not generally inflate if the vehicle is involved in a side or rear collision, if it rolls over, or if it is involved in a low-speed frontal collision. But, whenever a collision of any type causes sufficient forward deceleration of the vehicle, deployment of the SRS front airbags may occur.

- Collision from the side
- Collision from the rear
- Vehicle rollover

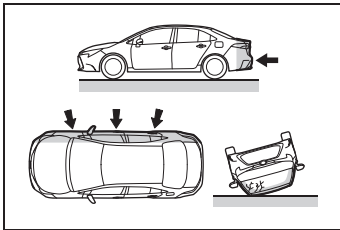

■ **Types of collisions that may not deploy the SRS airbags (SRS side and curtain shield airbags)**

The SRS side and curtain shield airbags may not activate if the vehicle is subjected to a collision from the side at certain angles, or a collision to the side of the vehicle body other than the passenger compartment.

- Collision from the side to the vehicle body other than the passenger compartment
- Collision from the side at an angle

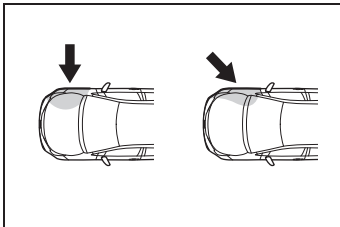

The SRS side airbags do not generally inflate if the vehicle is involved in a frontal or rear collision, if it rolls over, or if it is involved in a low-speed side collision.

- Collision from the front
- Collision from the rear
- Vehicle rollover

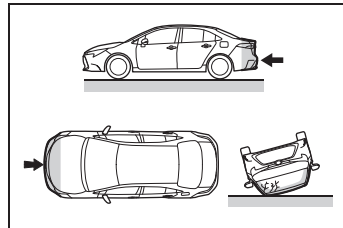

The SRS curtain shield airbags do not generally inflate if the vehicle is involved in a rear collision, if it rolls over, or if it is involved in a low-speed side or low-speed frontal collision.

- Collision from the rear
- Vehicle rollover

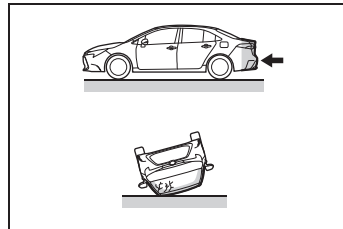

■ **When to contact your Toyota dealer**

In the following cases, the vehicle will require inspection and/or repair. Contact your Toyota dealer as soon as possible.

- Any of the SRS airbags have been inflated.
- The front of the vehicle is damaged or deformed, or was involved in an accident that was not severe enough to cause the SRS front airbags to inflate.

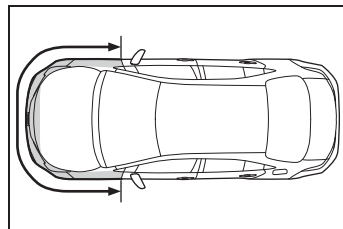

- A portion of a door or its surrounding

area is damaged, deformed or has had a hole made in it, or the vehicle was involved in an accident that was not severe enough to cause the SRS side and curtain shield airbags to inflate.

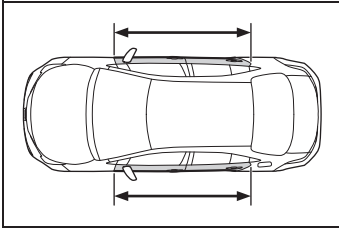

- The pad section of the steering wheel, dashboard near the front passenger airbag or lower portion of the instrument panel is scratched, cracked, or otherwise damaged.

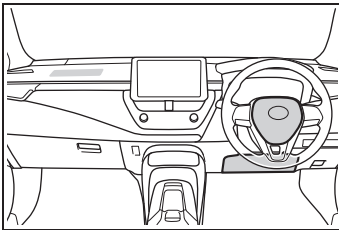

- The surface of the seats with the SRS side airbag is scratched, cracked, or otherwise damaged.

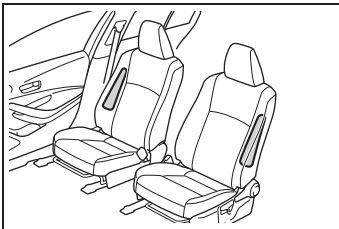

- The portion of the front pillars, rear pillars or roof side rail garnishes (padding) containing the SRS curtain shield airbags inside is scratched, cracked, or otherwise damaged.

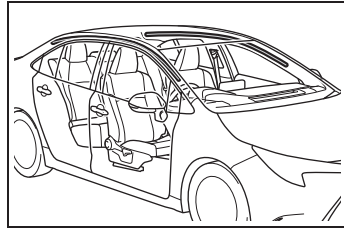

WARNING

■ SRS airbag precautions

Observe the following precautions regarding the SRS airbags. Failure to do so may cause death or serious injury.

- The driver and all passengers in the vehicle must wear their seat belts properly. The SRS airbags are supplemental devices to be used with the seat belts.
- The SRS driver airbag deploys with considerable force, and can cause death or serious injury especially if the driver is very close to the airbag.

Since the risk zone for the driver's airbag is the first 50 - 75 mm (2 - 3 in.) of inflation, placing yourself 250 mm (10 in.) from your driver airbag provides you with a clear margin of safety. This distance is measured from the center of the steering wheel to your breastbone. If you sit less than 250 mm (10 in.) away now, you can change your driving position in several ways:

- Move your seat to the rear as far as you can while still reaching the pedals comfortably.



WARNING

- Slightly recline the back of the seat. Although vehicle designs vary, many drivers can achieve the 250 mm (10 in.) distance, even with the driver seat all the way forward, simply by reclining the back of the seat somewhat. If reclining the back of your seat makes it hard to see the road, raise yourself by using a firm, non-slippery cushion, or raise the seat if your vehicle has that feature.
- If your steering wheel is adjustable, tilt it downward. This points the airbag toward your chest instead of your head and neck.

The seat should be adjusted as recommended above, while still maintaining control of the foot pedals, steering wheel, and your view of the instrument panel controls.

- The SRS front passenger airbag also deploys with considerable force, and can cause death or serious injury especially if the front passenger is very close to the airbag. The front passenger seat should be as far from the airbag as possible with the seatback adjusted, so the front passenger sits upright.
- Improperly seated and/or restrained infants and children can be killed or seriously injured by a deploying airbag. An infant or child who is too small to use a seat belt should be properly secured using a child restraint system. Toyota strongly recommends that all infants and children be placed in the rear seats of the vehicle and properly restrained. The rear seats are safer for infants and children than the front passenger seat. (→P.39)

- Do not sit on the edge of the seat or lean against the dashboard.

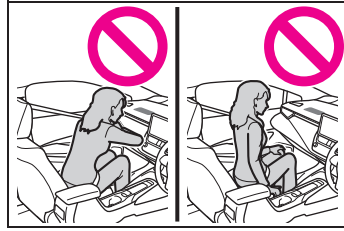

- Do not allow a child to stand in front of the SRS front passenger airbag unit or sit on the knees of a front passenger.

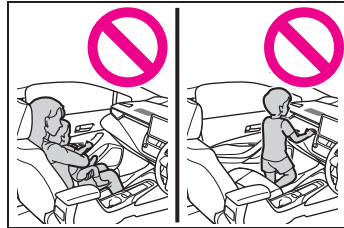

- Do not allow the front seat occupants to hold items on their knees.
- Do not lean against the door, the roof side rail or the front, side and rear pillars.

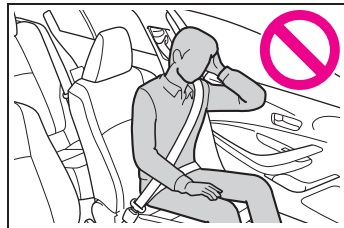

⚠ WARNING

- Do not allow anyone to kneel on the passenger seat toward the door or put their head or hands outside the vehicle.



- Do not attach anything to or lean anything against areas such as the dashboard, steering wheel pad and lower portion of the instrument panel. These items can become projectiles when the SRS driver, front passenger and knee airbags deploy.

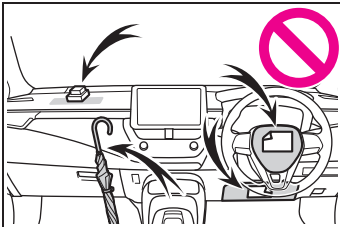

- Do not attach anything to areas such as a door, windshield, side windows, front or rear pillar, roof side rail and assist grip. (Except for the speed limit label →P.310)

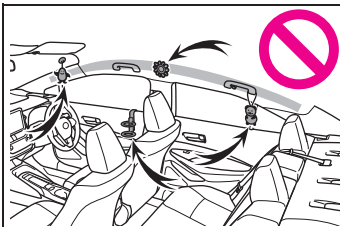

- Do not hang coat hangers or other hard objects on the coat hooks. All of these items could become projectiles and may cause death or serious injury, should the SRS curtain shield airbags deploy.
- If a vinyl cover is put on the area where the SRS driver's knee airbag will deploy, be sure to remove it.
- Do not use seat accessories which cover the parts where the SRS side airbags inflate as they may interfere with inflation of the SRS airbags. Such accessories may prevent the side airbags from activating correctly, disable the system or cause the side airbags to inflate accidentally, resulting in death or serious injury.
- Do not strike or apply significant levels of force to the area of the SRS airbag components or the front doors. Doing so can cause the SRS airbags to malfunction.
- Do not touch any of the component parts immediately after the SRS airbags have deployed (inflated) as they may be hot.
- If breathing becomes difficult after the SRS airbags have deployed, open a door or window to allow fresh air in, or leave the vehicle if it is safe to do so. Wash off any residue as soon as possible to prevent skin irritation.
- If the areas where the SRS airbags are stored, such as the steering wheel pad and front and rear pillar garnishes, are damaged or cracked, have them replaced by your Toyota dealer.

**WARNING****■ Modification and disposal of SRS airbag system components**

Do not dispose of your vehicle or perform any of the following modifications without consulting your Toyota dealer. The SRS airbags may malfunction or deploy (inflate) accidentally, causing death or serious injury.

- Installation, removal, disassembly and repair of the SRS airbags
- Repairs, modifications, removal or replacement of the steering wheel, instrument panel, dashboard, seats or seat upholstery, front, side and rear pillars, roof side rails, front door panels, front door trims or front door speakers
- Modifications to the front door panel (such as making a hole in it)
- Repairs or modifications of the front fender, front bumper, or side of the occupant compartment
- Installation of a grille guard (bull bars, kangaroo bar, etc.), snow plows, winches
- Modifications to the vehicle's suspension system
- Installation of electronic devices such as mobile two-way radios (RF-transmitter) and CD players

Exhaust gas precautions

Harmful substance to the human body is included in exhaust gases if inhaled.

**WARNING**

Exhaust gases include harmful carbon monoxide (CO), which is colorless and odorless. Observe the following precautions.

Failure to do so may cause exhaust gases enter the vehicle and may lead to an accident caused by light-headedness, or may lead to death or a serious health hazard.

■ Important points while driving

- Keep the trunk lid closed.
- If you smell exhaust gases in the vehicle even when the trunk lid is closed, open the windows and have the vehicle inspected at your Toyota dealer as soon as possible.

■ When parking

- If the vehicle is in a poorly ventilated area or a closed area, such as a garage, stop the hybrid system.
- Do not leave the vehicle with the hybrid system on for a long time. If such a situation cannot be avoided, park the vehicle in an open space and ensure that exhaust fumes do not enter the vehicle interior.
- Do not leave the hybrid system operating in an area with snow build-up, or where it is snowing. If snowbanks build up around the vehicle while the hybrid system is operating, exhaust gases may collect and enter the vehicle.

**WARNING****■ Exhaust pipe**

The exhaust system needs to be checked periodically. If there is a hole or crack caused by corrosion, damage to a joint or abnormal exhaust noise, be sure to have the vehicle inspected and repaired by your Toyota dealer.

Riding with children

Observe the following precautions when children are in the vehicle.

Use a child restraint system appropriate for the child, until the child becomes large enough to properly wear the vehicle's seat belt.

- It is recommended that children sit in the rear seats to avoid accidental contact with the shift lever, wiper switch, etc.
- Use the rear door child-protector lock or the window lock switch to avoid children opening the door while driving or operating the power window accidentally. (→P.108, 127)
- Do not let small children operate equipment which may catch or pinch body parts, such as the power window, hood, trunk, seats, etc.



WARNING

■ When children are in the vehicle

Never leave children unattended in the vehicle, and never allow children to have or use the key.

Children may be able to start the vehicle or shift the vehicle into neutral. There is also a danger that children may injure themselves by playing with the windows, the moon roof (if equipped) or other features of the vehicle. In addition, heat build-up or extremely cold temperatures inside the vehicle can be fatal to children.

Child restraint systems

Before installing a child restraint system in the vehicle, there are precautions that need to be observed, different types of child restraint systems, as well as installation methods, etc., written in this manual.

Use a child restraint system when riding with a small child that cannot properly use a seat belt. For the child's safety, install the child restraint system to a rear seat. Be sure to follow the installation method that is in the operation manual enclosed with the restraint system.

Table of contents

Points to remember: P.39

When using a child restraint system: P.40

Child restraint system compatibility for each seating position: P.43

Child restraint system installation method: P.47

- Fixed with a seat belt: P.48
- Fixed with an ISOFIX rigid anchor: P.50
- Using a child restraint anchor fitting: P.51

Points to remember

- If child restraint system regulations exist in the country where

you reside, please contact your Toyota dealer for the child restraint system installation.

- Use a child restraint system until the child becomes large enough to properly wear the vehicle's seat belt.
- Choose a child restraint system appropriate to the age and size of the child.
- Note that not all child restraint systems can fit in all vehicles. Before using or purchasing a child restraint system, check the compatibility of the child restraint system with seat positions. (→P.43)



WARNING

■ When a child is riding

Observe the following precautions. Failure to do so may result in death or serious injury.

- For effective protection in automobile accidents and sudden stops, a child must be properly restrained, using a seat belt or child restraint system which is correctly installed. For installation details, refer to the operation manual enclosed with the child restraint system. General installation instruction is provided in this manual.
- Toyota strongly urges the use of a proper child restraint system that conforms to the weight and size of the child, installed on the rear seat. According to accident statistics, the child is safer when properly restrained in the rear seat than in the front seat.



WARNING

- Holding a child in your or someone else's arms is not a substitute for a child restraint system. In an accident, the child can be crushed against the windshield or between the holder and the interior of the vehicle.

■ Handling the child restraint system

If the child restraint system is not properly fixed in place, the child or other passengers may be seriously injured or even killed in the event of sudden braking, sudden swerving, or an accident.

- If the vehicle were to receive a strong impact from an accident, etc., it is possible that the child restraint system has damage that is not readily visible. In such cases, do not reuse the restraint system.
- Depending on the child restraint system, installation may be difficult or impossible. In those cases, check whether the child restraint system is suitable for installment in the vehicle. (→P.43) Be sure to install and observe the usage rules after carefully reading the child restraint system fixing method in this manual, as well as the operation manual enclosed with the child restraint system.
- Keep the child restraint system properly secured on the seat even if it is not in use. Do not store the child restraint system unsecured in the passenger compartment.
- If it is necessary to detach the child restraint system, remove it from the vehicle or store it securely in the trunk.

When using a child restraint system

■ When installing a child restraint system to a front passenger seat

For the safety of a child, install a child restraint system to a rear seat. When installing a child restraint system to a front passenger seat is unavoidable, adjust the seat as follows and install the child restraint system:

- Move the front seat fully rearward.
- If the passenger seat height can be adjusted, adjust the seat height to the upper most position.
- Adjust the seatback angle to the most upright position.

If there is a gap between the child seat and the seatback, adjust the seatback angle until good contact is achieved.

- If the head restraint interferes with your child restraint system, and the head restraint can be removed, remove the head restraint.

Otherwise, put the head restraint in the upper most position.

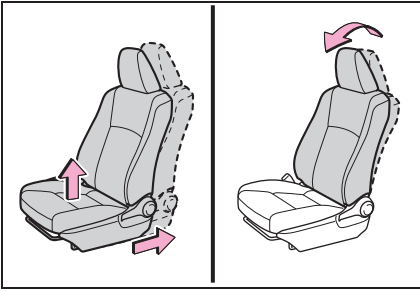

WARNING

■ When using a child restraint system

Observe the following precautions. Failure to do so may result in death or serious injury.

- Never use a rear-facing child restraint system on the front passenger seat. The force of the rapid inflation of the front passenger airbag can cause death or serious injury to children in the event of an accident.

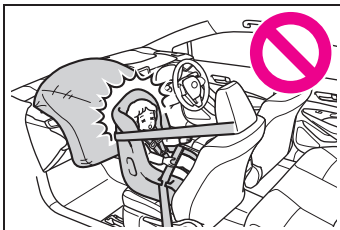

- **Extreme Hazard!** Do not use a rearward facing child restraint on a seat protected by an airbag in front of it! This is because the force of the rapid inflation of the front passenger airbag can cause death or serious injury to the child. There is a label(s) on the passenger side sun visor, indicating it is forbidden to attach a rear-facing child restraint system to the front passenger seat. Details of the label(s) are shown in the illustration below.

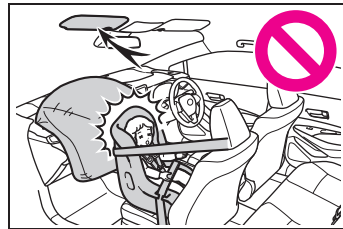

**WARNING****WARNING**

- Only put a forward-facing child restraint system on the front seat when unavoidable. When installing a forward-facing child restraint on the front passenger seat, move the seat as far back as possible. Failing to do so may result in death or serious injury if the airbags deploy (inflate).

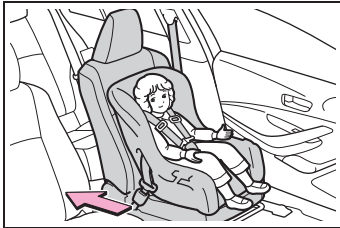

- Do not allow the child to lean his/her head or any part of his/her body against the door or the area of the seat, front or rear pillars, or roof side rails from which the SRS side airbags or SRS curtain shield airbags deploy even if the child is seated in the child restraint system. It is dangerous if the SRS side and curtain shield airbags inflate, and the impact could cause death or serious injury to the child.



- When a junior seat (booster seat) is installed, always ensure that the shoulder belt is positioned across the center of the child's shoulder. The belt should be kept away from the child's neck, but not so that it could fall off the child's shoulder.

⚠ WARNING

- Use child restraint system suitable to the age and size of the child and install it to the rear seat.
- If the driver's seat interferes with the child restraint system and prevents it from being attached correctly, attach the child restraint system to the left-hand rear seat.

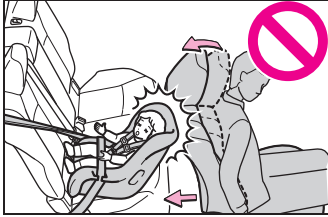

- Adjust the front passenger seat so that it does not interfere with the child restraint system.

Child restraint system compatibility for each seating position

■ Child restraint system compatibility for each seating position

Compatibility of each seating position with child restraint systems (→P.44) displays the type of child restraint systems that can be used and possible seating positions for installation using symbols. Check the selected child restraint system together with the following [Before confirming the compatibility of each seating position with child restraint systems].

■ Before confirming the compatibility of each seating position with child restraint systems

1 Checking the child restraint system standards.

Use a child restraint system that conforms to UN(ECE) R44*¹ or UN(ECE) R129*^{1, 2}.

The following approval mark is displayed on child restraint systems which are conformed.

Check for an approval mark attached to the child restraint system.

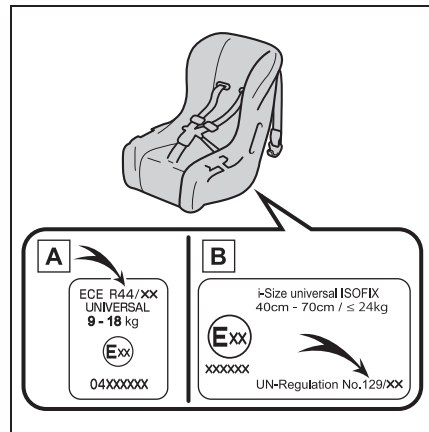

Example of the displayed regulation number

- A** UN(ECE) R44 approval mark*³
The weight range of the child who is applicable for an UN(ECE) R44 approval mark is indicated.
- B** UN(ECE) R129 approval mark*³
The height range of the child who is applicable as well as available weights for an

UN(ECE) R129 approval mark is indicated.

- 2 Checking the category of the child restraint system.
Check the approval mark of the child restraint system for which of the following categories the child restraint system is suitable. Also, if there are any uncertainties, check the user's guide included with the child restraint system or contact the retailer of the child restraint system.

- “universal”
- “semi-universal”
- “restricted”
- “vehicle specific”

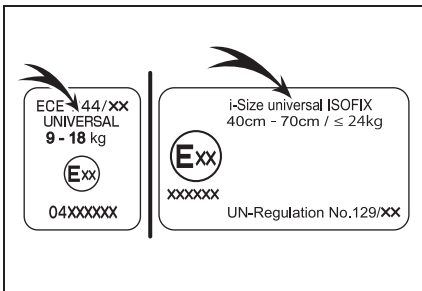





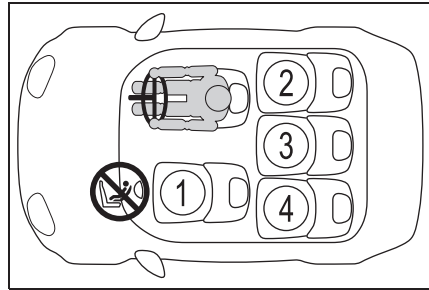

*1: UN(ECE) R44 and UN(ECE) R129 are U.N. regulations for child restraint systems.

*2: The child restraint systems mentioned in the table may not be available outside of the EU area.

*3: The displayed mark may differ depending on the product.

■ **Compatibility of each seating position with child restraint systems**



<p>①</p> <p>*1, 2, 3</p>	<p>U</p> <p>*4</p>	
<p>②</p> <p>*3</p>	<p>U</p> <p></p>	<p></p>
<p>③</p>	<p>U</p>	<p></p>
<p>④</p> <p>*3</p>	<p>U</p> <p></p>	<p></p>

U Suitable for “universal” category child restraint system fixed with the seat belt.

 Suitable for i-Size and ISOFIX child restraint system.



Includes a top tether anchorage point.



Never use a rear-facing child restraint system on the front passenger seat.

*1: Move the front seat fully rearward. If the passenger seat height can be adjusted, move it to the upper most position.

*2: Adjust the seatback angle to the most upright position. When installing a forward-facing child seat, if there is a gap between the child seat and the seatback, adjust the seatback angle until good contact is achieved.

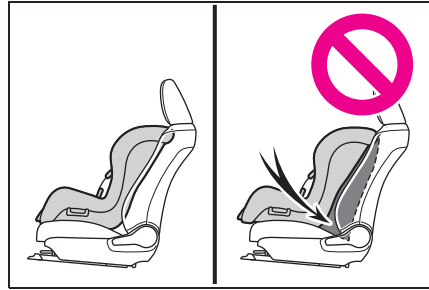

*3: If the head restraint interferes with your child restraint system, and the head restraint can be removed, remove the head restraint. Otherwise, put the head restraint in the upper most position.

*4: Use only a front-facing child restraint system.

Detail information for child restraint systems installation

Seating position				
Seat position number	①	②	③	④
Seating position suitable for universal belted (Yes/No)	Yes Forward facing only	Yes	Yes	Yes
i-Size seating position (Yes/No)	No	Yes	No	Yes
Seating position suitable for lateral fixture (L1/L2/No)	No	No	No	No
Suitable rearward facing fixture (R1/R2X/R2/R3/No)	No	R1, R2X, R2	No	R1, R2X, R2
Suitable forward facing fixture (F2X/F2/F3/No)	No	F2X, F2, F3	No	F2X, F2, F3
Suitable junior seat fixture (B2/B3/No)	No	B2, B3	No	B2, B3

ISOFIX child restraint systems are divided into different “fixture”. The child restraint system can be used in the seating positions for “fixture” mentioned in the table above. For kind of “fixture” relation, confirm the following table. If your child restraint system has no kind of “fixture” (or if you cannot find

information in the table below), please refer to the child restraint system “vehicle list” for compatibility information or ask the retailer of your child seat.

Fixture	Description
F3	Full-height, forward-facing child restraint systems
F2	Reduced-height forward-facing child restraint systems
F2X	Reduced-height forward-facing child restraint systems
R3	Full-size, rearward-facing child restraint systems
R2	Reduced-size, rearward-facing child restraint systems
R2X	Reduced-size, rearward-facing child restraint systems
R1	Rearward-facing infant seat
L1	Left lateral-facing (carrycot) infant seat
L2	Right lateral-facing (carrycot) infant seat
B2	Junior seat
B3	Junior seat

When securing some types of child restraint systems in rear seat, it may not be possible to properly use the seat belts in positions next to the child restraint without interfering with it or affecting seat belt effectiveness. Be sure your seat belt fits snugly across your shoulder and low on your hips. If it does not, or if it interferes with the child restraint, move to a different position. Failure to do so may result in death or serious injury.

- When installing a child restraint in the rear seats, adjust the front seat so that it does not interfere with the child or child restraint system.
- When installing a child seat with support base, if the child seat

interferes with the seatback when latching it into the support base, adjust the seatback rearward until there is no interference.

- If the seat belt shoulder anchor is ahead of the child seat belt guide, move the seat cushion forward.

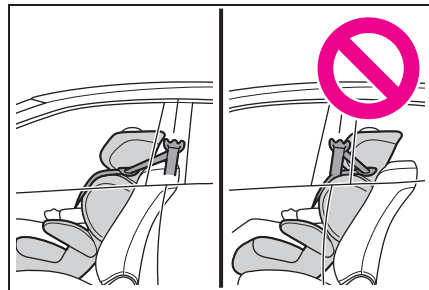

- When installing a junior seat, if the child in your child restraint

system is in a very upright position, adjust the seatback angle to the most comfortable position. And if the seat belt shoulder

anchor is ahead of the child seat belt guide, move the seat cushion forward.

Child restraint system installation method

Confirm with the operation manual enclosed with the child restraint system about the installation of the child restraint system.

	Installation method	Page
Seat belt attachment		P.48

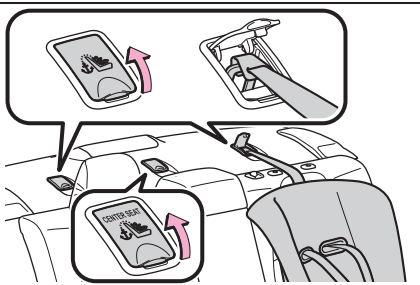
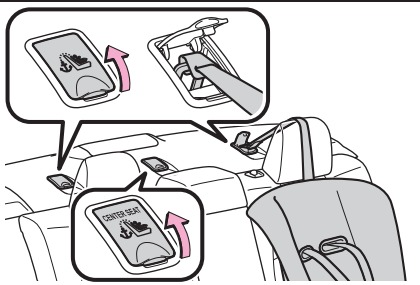
	Installation method	Page
<p>ISOFIX rigid anchor attachment</p>		<p>P.50</p>
<p>Child restraint anchor fitting attachment</p>	<p>Seats with an adjustable type head restraint:</p>  <p>Seats with an integrated type head restraint:</p> 	<p>P.51</p>

Child restraint system fixed with a seat belt

■ **Installing child restraint system using a seat belt**

Install the child restraint system in

accordance to the operation manual enclosed with the child restraint system.

If the child restraint system on hand is not within the “universal” category (or the necessary information is not in the table), refer to the “Vehicle List” provided by the child restraint system maker for various possible installation positions, or check the compatibility after asking the retailer of the child seat.

(→P.43, 44)

- 1 If installing the child restraint system to the front passenger seat is unavoidable, refer to P.40 for the front passenger seat adjustment.
- 2 If the head restraint interferes with your child restraint system, and the head restraint can be removed, remove the head restraint. Otherwise, put the head restraint in the upper most position. (→P.119)
- 3 Run the seat belt through the child restraint system and insert the plate into the buckle. Make sure that the belt is not twisted. Securely fix the seat belt to the child restraint system in accord-

ance to the directions enclosed with the child restraint system.

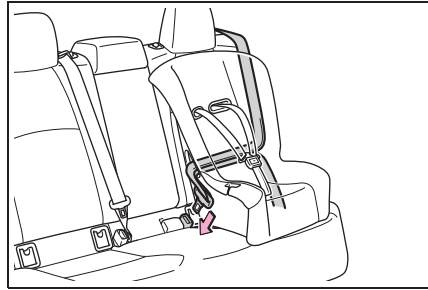

- 4 If your child restraint system is not equipped with a lock-off (a seat belt locking feature), secure the child restraint system using a locking clip.

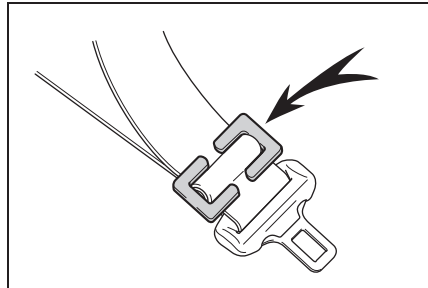

- 5 After installing the child restraint system, rock it back and forth to ensure that it is installed securely. (→P.50)

■ Removing a child restraint system installed with a seat belt

Press the buckle release button and fully retract the seat belt.

When releasing the buckle, the child restraint system may spring up due to the rebound of the seat cushion.

Release the buckle while holding down the child restraint system.

Since the seat belt automatically reels itself, slowly return it to the stowing position.

■ When installing a child restraint system

You may need a locking clip to install the child restraint system. Follow the instructions provided by the manufacturer of the system. If your child restraint system does not provide a locking clip, you can purchase the following item from your Toyota dealer: Locking clip for child restraint system (Part No. 73119-22010)



WARNING

■ When installing a child restraint system

Observe the following precautions. Failure to do so may result in death or serious injury.

- Do not allow children to play with the seat belt. If the seat belt becomes twisted around a child's neck, it may lead to choking or other serious injuries that could result in death. If this occurs and the buckle cannot be unfastened, scissors should be used to cut the belt.
- Ensure that the belt and plate are securely locked and the seat belt is not twisted.
- Shake the child restraint system left and right, and forward and backward to ensure that it has been securely installed.
- After securing a child restraint system, never adjust the seat.

- When a junior seat (booster seat) is installed, always ensure that the shoulder belt is positioned across the center of the child's shoulder. The belt should be kept away from the child's neck, but not so that it could fall off the child's shoulder.
- Follow all installation instructions provided by the child restraint system manufacturer.

Child restraint system fixed with an ISOFIX rigid anchor

■ ISOFIX rigid anchors (ISOFIX child restraint system)

Lower anchors are provided for the outboard rear seats. (Marks displaying the location of the anchors are attached to the seats.)

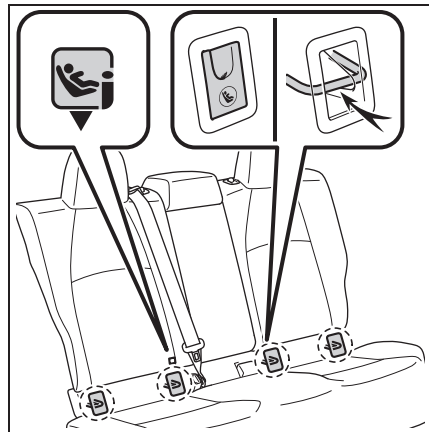

■ Installation with ISOFIX rigid anchor (ISOFIX child restraint system)

Install the child restraint system in accordance to the operation manual enclosed with the child restraint system.

If the child restraint system on hand is not within the “universal” category (or the necessary information is not in the table), refer to the “Vehicle List” provided by the child restraint system maker for various possible installation positions, or check the compatibility after asking the retailer of the child seat. (→P.43, 44)

- 1 If the head restraint interferes with your child restraint system, and the head restraint can be removed, remove the head restraint. Otherwise, put the head restraint in the upper most position. (→P.119)
- 2 Remove the anchorage covers, and install the child restraint system to the seat.

The bars are installed behind the anchorage covers.

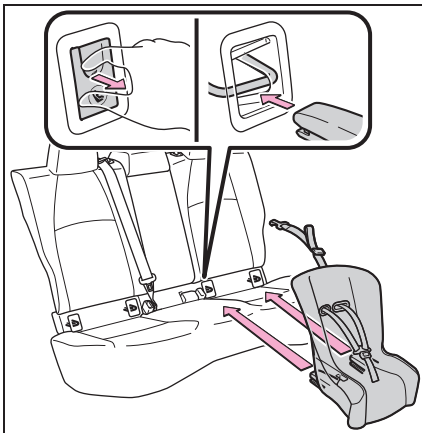

- 3 After installing the child restraint system, rock it back and forth to

ensure that it is installed securely. (→P.50)

⚠ WARNING

■ When installing a child restraint system

Observe the following precautions. Failure to do so may result in death or serious injury.

- After securing a child restraint system, never adjust the seat.
- When using the lower anchors, be sure that there are no foreign objects around the anchors and that the seat belt is not caught behind the child restraint system.
- Follow all installation instructions provided by the child restraint system manufacturer.

■ Using child restraint anchorages

WARNING: child restraint anchorages are designed to withstand only those loads imposed by correctly fitted child restraints. Under no circumstances are they to be used for adult seatbelts, harnesses, or for attaching other items or equipment to the vehicle.

Using a child restraint anchor fitting

■ Child restraint anchor fitting

Anchor fittings are provided for each rear seat.

Use anchor fitting when fixing the strap.

- ▶ Seats with an adjustable type head restraint

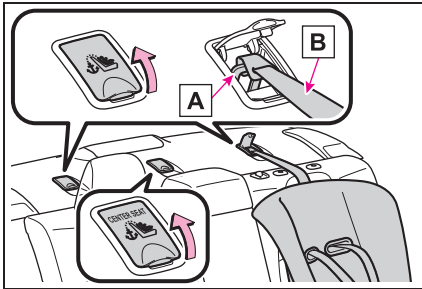

- A** Anchor fittings
- B** Upper anchorage strap

- ▶ Seats with an integrated type head restraint

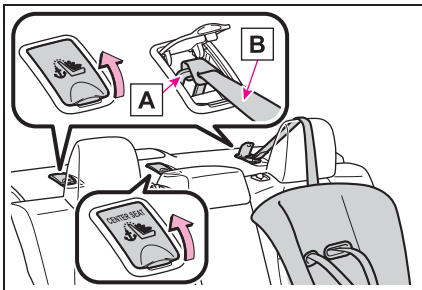

- A** Anchor fittings
- B** Upper anchorage strap

■ Fixing the strap to the anchor fitting

Install the child restraint system in accordance to the operation manual enclosed with the child restraint system.

- ▶ Rear outboard seats
- 1 Seats with an adjustable type head restraint: Adjust the head restraint to the upmost position. If the head restraint interferes with the

child restraint system or upper anchorage strap installation and the head restraint can be removed, remove the head restraint. (→P.119)

- 2 Open the anchor fitting cover, latch the attaching clip onto the anchor fitting and tighten the upper anchorage strap.

Make sure the upper anchorage strap is securely latched. (→P.50)

When installing the child restraint system with the head restraint being raised, be sure to have the upper anchorage strap pass underneath the head restraint.

Seats with an adjustable type head restraint:

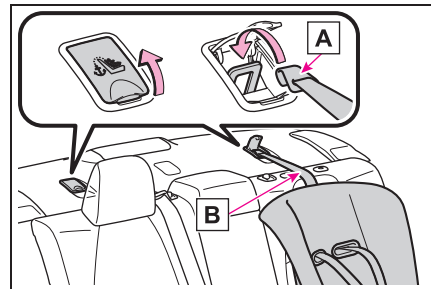

- A** Attaching clip
- B** Upper anchorage strap

Seats with an integrated type head restraint:

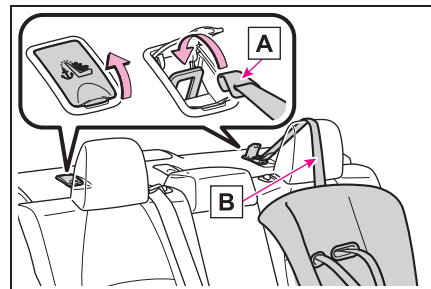

- A** Attaching clip
- B** Upper anchorage strap

► Rear center seat

Open the anchor fitting cover, latch the attaching clip onto the anchor fitting and tighten the upper anchor-strap.

Make sure the upper anchorage strap is securely latched. (→P.50)

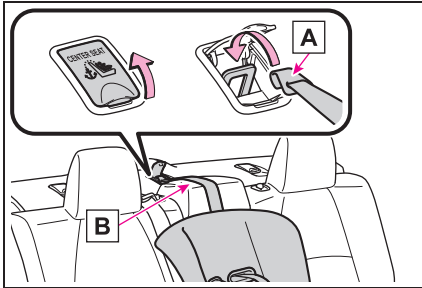

A Attaching clip

B Upper anchorage strap



WARNING

■ **When installing a child restraint system**

Observe the following precautions. Failure to do so may result in death or serious injury.

- Firmly attach the upper anchorage strap and make sure that the belt is not twisted.
- Do not attach the upper anchorage strap to anything other than the anchor fitting.
- After securing a child restraint system, never adjust the seat.
- Follow all installation instructions provided by the child restraint system manufacturer.



NOTICE

■ **Child restraint anchor fitting**

When not in use, make certain to close the lid. If it remains open, the lid may be damaged.

Toyota Connected Services^{*1, 2}

^{*1}: If equipped

^{*2}: Operates within the Toyota Connected Services coverage.

Toyota Connected Services are telematics services that use Global Positioning System (GPS) data and embedded cellular technology to enable the following emergency calls to be made: ACN (Automatic Collision Notification) and SOS Emergency Call (Manual emergency service notification) (by pressing the “SOS” button).

For more information about Toyota Connected Services, please visit:
<https://www.toyota.com.au/connected>

System components

► Type A

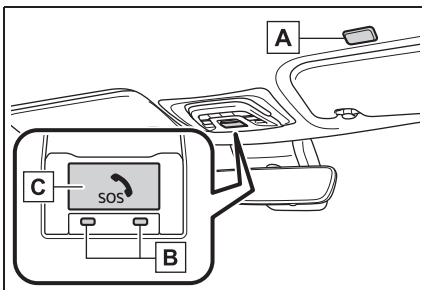

► Type B

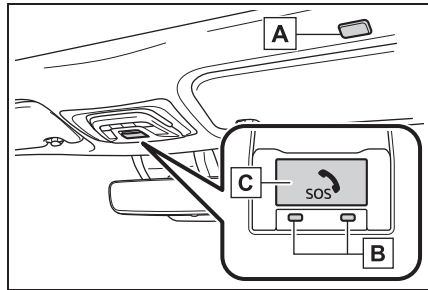

A Microphone (driver's side)

B Indicator lights

C “SOS” button^{*}

^{*}: This button is intended for communication with the Call Centre Agent. Other SOS buttons available in other systems of a motor vehicle do not relate to the device and are not intended for communication with the Call Centre Agent.

Toyota Connected Services

■ ACN (Automatic Collision Notification)

If any airbag deploys, the system is designed to automatically call the Emergency Call Centre.* The Call Centre Agent will determine your vehicle's location, the time of the incident and the vehicle VIN, and attempt to speak with the vehicle occupants to assess the situation. If the occupants are unable to communicate, the Call Centre Agent automatically treats the call as an emergency and contacts emergency services to describe the situation and request that assistance be sent

to the location.

*: In some cases, the call cannot be made. (→P.55)

■ SOS Emergency Call (Manual emergency service notification)

In the event of an emergency, press the “SOS” button to call the Emergency Call Centre.* The Call Centre Agent will determine your vehicle’s location, assess the situation, and dispatch the necessary assistance required.

Make sure to open the cover before pressing the “SOS” button.

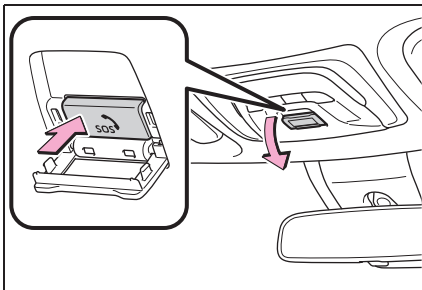

If you accidentally press the “SOS” button, tell the Call Centre Agent that you are not experiencing an emergency.

*: In some cases, the call cannot be made. (→P.55)

Indicator lights

When the power switch is turned to ON, the red/green indicator lights will blink intermittently, then the green indicator light will remain ON, indicating that the system is enabled. The indicator lights indicate the following:

- If the green indicator light illuminates and stays on, the system is enabled.
- If the green indicator light flashes twice per second, the ACN/SOS service is being made.
- If the red indicator light illuminates at any time other than immediately after the power switch is turned to ON, the system may be malfunctioning or the backup battery may be depleted. Contact your Toyota dealer.

■ Free/Open Source Software Information

This product contains Free/Open Source Software (FOSS).

The license information and/or the source code of such FOSS can be found at the following URL.

<http://www.opensourceautomotive.com/dcm/19MC/>

⚠ WARNING

■ When the ACN/SOS may not be made

- It may not be possible to make ACN/SOS in any of the following situations. In such cases, report to emergency services provider (000 system etc.) by other means such as nearby public phones.
- Even when the vehicle is in the cellular phone service area, it may be difficult to connect to the Emergency Call Centre if the reception is poor or the line is busy. In such cases, you may not be able to connect the Emergency Call Centre.



WARNING

- When the vehicle is out of the cellular phone service area, the ACN/SOS cannot be made.
- When any related equipment (such as the “SOS” button panel, indicator lights, microphone, DCM, antenna, or any wires connecting the equipment) is malfunctioning, damaged or broken, the ACN/SOS cannot be made.
- During an ACN/SOS service, the system makes repeated attempts to connect to the Emergency Call Centre. However, if it cannot connect to the Emergency Call Centre due to poor radio wave reception, the system may not be able to connect to the cellular network and the call may finish without connecting. A voice prompt notification will play from the vehicle speaker to indicate call disconnection.
- If the 12-volt battery's voltage decreases or there is a disconnection, the system may not be able to connect to the Emergency Call Centre.
- The ACN/SOS system might not work outside of Australia region, depending on the available infrastructure in the country.

■ When the ACN/SOS system is replaced with a new one

The ACN/SOS system should be registered. Contact your Toyota dealer.

■ For your safety

- Please drive safely.
The function of this system is to assist you in contacting the appropriate emergency services in case of accidents such as traffic accidents or sudden medical emergencies, and it does not protect the driver or passengers in any way. Please drive safely and fasten your seatbelts at all times for your safety.
- In case of an emergency, ensure preservation of life is prioritised first.
- If you smell anything burning or other unusual smells, leave the vehicle and evacuate to a safe area immediately.
- If the airbags deploy when the system is operating normally, the system makes emergency call. The system also makes emergency call when the vehicle is struck from the rear or rolls over, even if the airbags do not deploy.
- For safety, do not press the “SOS” button while driving.
Making calls during driving may cause mishandling of the steering wheel, which may lead to unexpected accidents. Stop the vehicle and confirm the safety of your surroundings before pressing the “SOS” button.
- When changing fuses, please use the specified fuses. Using other fuses may cause ignition or smoke in the circuit and lead to a fire.
- Using the system while there is smoke or an unusual smell may cause a fire. Stop using the system immediately and consult your Toyota dealer.

**NOTICE****■ To prevent damage**

Do not pour any liquids onto the “SOS” button panel, etc. and do not impact it.

■ If the “SOS” button panel, speaker or microphone malfunctions during an ACN/SOS service

It may not be possible to make ACN/SOS, confirm the system status, or communicate with the Call Centre Agent. If any of the above equipment is damaged, please consult your Toyota dealer.

Hybrid system features

Your vehicle is a hybrid vehicle. It has characteristics different from conventional vehicles. Be sure you are closely familiar with the characteristics of your vehicle, and operate it with care.

The hybrid system combines the use of a gasoline engine and an electric motor (traction motor) according to driving conditions, improving fuel efficiency and reducing exhaust emissions.

System components

■ System components

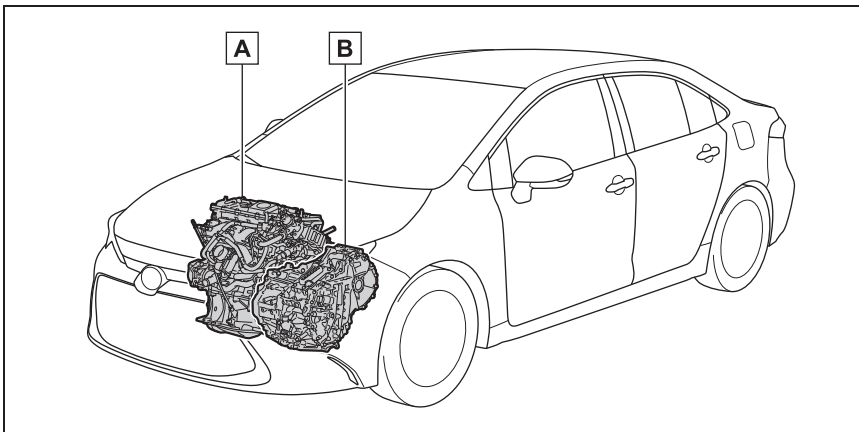

The illustration is an example for explanation and may differ from the actual item.

A Gasoline engine

B Electric motor (traction motor)

■ When stopped/during start off

The gasoline engine stops* when the vehicle is stopped. During start off, the electric motor (traction motor) drives the vehicle. At slow speeds or when traveling down a gentle slope, the engine is stopped* and the electric motor (traction motor) is used.

When the shift lever is in N, the hybrid battery (traction battery) is not being charged.

*: When the hybrid battery (traction battery) requires charging or the engine is warming up, etc., the gasoline engine will not automatically stop. (→P.59)

■ During normal driving

The gasoline engine is predominantly used. The electric motor (traction motor) charges the hybrid battery (traction battery) as necessary.

■ When accelerating sharply

When the accelerator pedal is depressed heavily, the power of the hybrid battery (traction battery) is added to that of the gasoline engine via the electric motor (traction motor).

■ When braking (regenerative braking)

The wheels operate the electric motor (traction motor) as a power generator, and the hybrid battery (traction battery) is charged.

■ Regenerative braking

In the following situations, kinetic energy is converted to electric energy and deceleration force can be obtained in conjunction with the recharging of the hybrid battery (traction battery).

- The accelerator pedal is released while driving with the shift lever in D or B.
- The brake pedal is depressed while driving with the shift lever in D or B.

■ EV indicator

The EV indicator comes on when the vehicle is driven using only the electric motor (traction motor) or the gasoline engine is stopped.

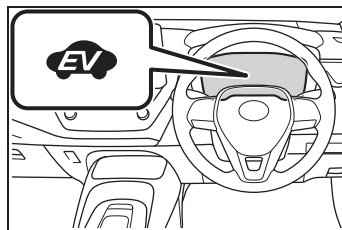

■ Conditions in which the gasoline engine may not stop

The gasoline engine starts and stops automatically. However, it may not stop automatically in the following conditions:

- During gasoline engine warm-up
- During hybrid battery (traction battery) charging
- When the temperature of the hybrid battery (traction battery) is high or low
- When the heater is switched on

Depending on the circumstances, the gasoline engine may also not stop automatically in other situations.

■ Charging the hybrid battery (traction battery)

As the gasoline engine charges the hybrid battery (traction battery), the battery does not need to be charged from an outside source. However, if the vehicle is left parked for a long time the hybrid battery (traction battery) will slowly discharge. For this reason, be sure to drive the vehicle at least once every few months for at least 30 minutes or 16 km (10 miles). If the hybrid battery (traction battery) becomes fully discharged and you are unable to start the hybrid system, contact your Toyota dealer.

■ Charging the 12-volt battery

→P.331

■ After the 12-volt battery has discharged or when the terminal has been removed and installed during exchange, etc.

The gasoline engine may not stop even if the vehicle is being driven by the hybrid battery (traction battery). If this

continues for a few days, contact your Toyota dealer.

■ Sounds and vibrations specific to a hybrid vehicle

There may be no engine sound or vibration even though the vehicle is able to move with the "READY" indicator is illuminated. For safety, apply the parking brake and make sure to shift the shift lever to P when parked.

The following sounds or vibrations may occur when the hybrid system is operating and are not a malfunction:

- Motor sounds may be heard from the engine compartment.
- Sounds may be heard from the hybrid battery (traction battery) under the rear seats when the hybrid system starts or stops.
- Relay operating sounds such as a snap or soft clank will be emitted from the hybrid battery (traction battery), under the rear seats, when the hybrid system is started or stopped.
- Sounds from the hybrid system may be heard when the trunk lid is open.
- Sounds may be heard from the transmission when the gasoline engine starts or stops, when driving at low speeds, or during idling.
- Engine sounds may be heard when accelerating sharply.
- Sounds may be heard due to regenerative braking when the brake pedal is depressed or as the accelerator pedal is released.
- Vibration may be felt when the gasoline engine starts or stops.
- Cooling fan sounds may be heard from the air intake vent on the side of the lower part of the rear left seat.

■ Maintenance, repair, recycling, and disposal

Contact your Toyota dealer regarding maintenance, repair, recycling and disposal. Do not dispose of the vehicle yourself.

■ Customization

Some functions can be customized. (→P.346)

Hybrid system precautions

Take care when handling the hybrid system, as it is a high voltage system (about 600 V at maximum) as well as contains parts that become extremely hot when the hybrid system is operating. Obey the warning labels attached to the vehicle.

System components

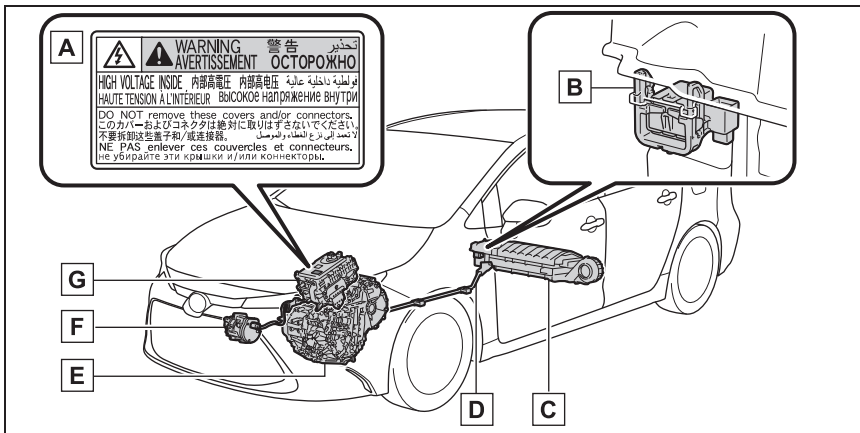

The illustration is an example for explanation and may differ from the actual item.

- A** Warning label
- B** Service plug
- C** Hybrid battery (traction battery)
- D** High voltage cables (orange)
- E** Electric motor (traction motor)
- F** Air conditioning compressor
- G** Power control unit

■ Running out of fuel

When the vehicle has run out of fuel and the hybrid system cannot be started, refuel the vehicle with at least enough gasoline to make the low fuel level warning light (→P.300) go off. If there is only a small amount of fuel, the hybrid sys-

tem may not be able to start. (The standard amount of fuel is about 7.6 L [2.0 gal., 1.7 Imp. gal.] when the vehicle is on a level surface. This value may vary when the vehicle is on a slope. Add extra fuel when the vehicle is inclined.)

■ Electromagnetic waves

- High voltage parts and cables on hybrid vehicles incorporate electromagnetic shielding, and therefore emit approximately the same amount of electromagnetic waves as conventional gasoline powered vehicles or home electronic appliances.
- Your vehicle may cause sound interference in some third party-produced radio parts.

■ Hybrid battery (traction battery)

The hybrid battery (traction battery) has a limited service life. The lifespan of the hybrid battery (traction battery) can change in accordance with driving style and driving conditions.

■ Starting the hybrid system in an extremely cold environment

When the hybrid battery (traction battery) is extremely cold (below approximately -30°C [-22°F]) under the influence of the outside temperature, it may not be possible to start the hybrid system. In this case, try to start the hybrid system again after the temperature of the hybrid battery increases due to the outside temperature increasing, etc.



WARNING

■ High voltage precautions

This vehicle has high voltage DC and AC systems as well as a 12-volt system. DC and AC high voltage is very dangerous and can cause severe burns and electric shock that may result in death or serious injury.

- Never touch, disassemble, remove or replace the high voltage parts, cables or their connectors.
- The hybrid system will become hot after starting as the system uses high voltage. Be careful of both the high voltage and the high temperature, and always obey the warning labels attached to the vehicle.

- Never try to open the service plug access hole located under the right side of the rear seat. The service plug is used only when the vehicle is serviced and is subject to high voltage.

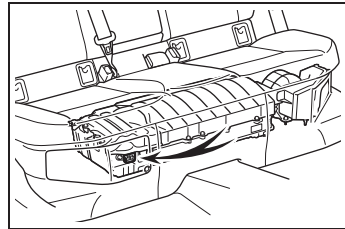

■ Road accident cautions

Observe the following precautions to reduce the risk of death or serious injury:

- Pull your vehicle off the road, apply the parking brake, shift the shift lever to P, and turn the hybrid system off.
- Do not touch the high voltage parts, cables and connectors.
- If electric wires are exposed inside or outside your vehicle, an electric shock may occur. Never touch exposed electric wires.
- If a fire occurs in the hybrid vehicle, leave the vehicle as soon as possible. Never use a fire extinguisher that is not meant for electric fires. Using even a small amount of water may be dangerous.
- If your vehicle needs to be towed, do so with the front wheels raised. If the wheels connected to the electric motor (traction motor) are on the ground when towing, the motor may continue to generate electricity. This may cause a fire. (→P.293)

**WARNING**

- Carefully inspect the ground under the vehicle. If you find that liquid has leaked onto the ground, the fuel system may have been damaged. Leave the vehicle as soon as possible.
 - Do not touch the battery if liquid is leaking from or adhering to it. If electrolyte (carbonic-based organic electrolyte) from the hybrid battery (traction battery) comes into contact with the eyes or skin, it could cause blindness or skin wounds. In the unlikely event that it comes into contact with the eyes or skin, wash it off immediately with a large amount of water, and seek immediate medical attention.
 - If electrolyte is leaking from the hybrid battery (traction battery), do not approach the vehicle. Even in the unlikely event that the hybrid battery (traction battery) is damaged, the internal construction of the battery will prevent a large amount of electrolyte from leaking out. However, any electrolyte that does leak out will give off a vapor. This vapor is an irritant to skin and eyes and could cause acute poisoning if inhaled.
 - Do not bring burning or high-temperature items close to the electrolyte. The electrolyte may ignite and cause a fire.
- **Hybrid battery (traction battery)**
- Your vehicle contains a sealed lithium-ion battery.

- Never resell, hand over or modify the hybrid battery. To prevent accidents, hybrid batteries that have been removed from a disposed vehicle are collected through Toyota dealer. Do not dispose of the battery yourself.

Unless the battery is properly collected, the following may occur, resulting in death or serious injury:

- The hybrid battery may be illegally disposed of or dumped, and it is hazardous to the environment or someone may touch a high voltage part, resulting in an electric shock.
- The hybrid battery is intended to be used exclusively with your hybrid vehicle. If the hybrid battery is used outside of your vehicle or modified in any way, accidents such as electric shock, heat generation, smoke generation, an explosion and electrolyte leakage may occur.

When reselling or handing over your vehicle, the possibility of an accident is extremely high because the person receiving the vehicle may not be aware of these dangers.

- If your vehicle is disposed of without the hybrid battery having been removed, there is a danger of serious electric shock if high voltage parts, cables and their connectors are touched. In the event that your vehicle must be disposed of, the hybrid battery must be disposed of by your Toyota dealer or a qualified service shop. If the hybrid battery is not disposed of properly, it may cause electric shock that can result in death or serious injury.



NOTICE

Hybrid battery (traction battery)

Do not carry large amounts of water such as water cooler bottles in the vehicle. If water spills onto the hybrid battery (traction battery), the battery may be damaged. Have the vehicle inspected by your Toyota dealer.

Hybrid battery (traction battery) air intake vent

There are air intake vents under the left side of the rear seat with the purpose of cooling the hybrid battery (traction battery).

If the vents are blocked, it may interfere with the cooling of the hybrid battery (traction battery).

If input/output of the hybrid battery (traction battery) becomes limited and the distance that the vehicle can be driven using the electric motor (traction motor) is reduced, the fuel economy may be reduced.

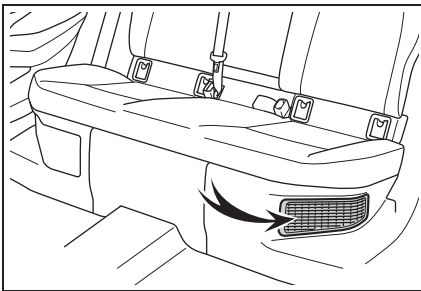

NOTICE

Hybrid battery (traction battery) air intake vent

- Make sure not to block the air intake vent with anything, such as a seat cover, plastic cover, or luggage.

The input/output of the hybrid battery (traction battery) may be restricted, leading to a reduction in hybrid battery (traction battery) output and a malfunction.

- Periodically clean the air intake vents to prevent them from clogging. (→P.278)
- Do not get water or foreign materials in the air intake vents as this may cause a short circuit and damage the hybrid battery (traction battery).

Emergency shut off system

When a certain level of impact is detected by the impact sensor, the emergency shut off system blocks the high voltage current and stops the fuel pump to minimize the risk of electrocution and fuel leakage. If the emergency shut off system activates, your vehicle will not restart. To restart the hybrid system, contact your Toyota dealer.

Hybrid warning message

A message is automatically displayed when a malfunction occurs in the hybrid system or an improper operation is attempted.

If a warning message is shown on the multi-information display, read

the message and follow the instructions.

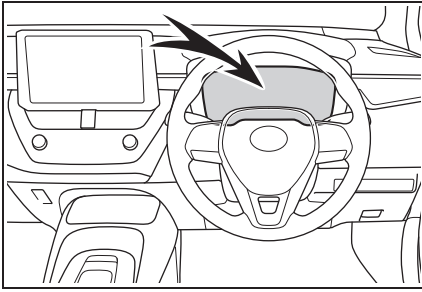

■ **If a warning light comes on, a warning message is displayed, or the 12-volt battery is disconnected**

The hybrid system may not start. In this case, try to start the system again. If the "READY" indicator does not come on, contact your Toyota dealer.

Immobilizer system

The vehicle's keys have built-in transponder chips that prevent the hybrid system from starting if a key has not been previously registered in the vehicle's on-board computer.

Never leave the keys inside the vehicle when you leave the vehicle.

This system is designed to help prevent vehicle theft but does not guarantee absolute security against all vehicle thefts.

Operating the system

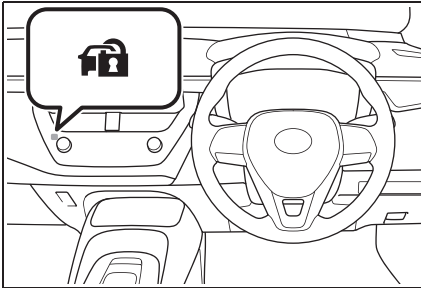

The indicator light flashes after the power switch has been turned off to indicate that the system is operating.

The indicator light stops flashing after the power switch has been turned to ACC or ON to indicate that the system has been canceled.

System maintenance

The vehicle has a maintenance-free type immobilizer system.

Conditions that may cause the system to malfunction

- If the grip portion of the key is in contact with a metallic object
- If the key is in close proximity to or touching a key to the security system (key with a built-in transponder chip) of another vehicle



NOTICE

To ensure the system operates correctly

Do not modify or remove the system. If modified or removed, the proper operation of the system cannot be guaranteed.

2-1. Instrument cluster

Warning lights and indicators **68**

Gauges and meters (7-inch display) **72**

Gauges and meters (12.3-inch display) **75**

Multi-information display (7-inch display) **80**

Multi-information display (12.3-inch display) **86**

Head-up display **93**

Energy monitor/consumption screen **97**

Warning lights and indicators

The warning lights and indicators on the instrument cluster, center panel and outside rear view mirrors inform the driver of the status of the vehicle's various systems.

Warning lights and indicators displayed on the instrument cluster

For the purpose of explanation, the following illustrations display all warning lights and indicators illuminated.

► 7-inch display



► 12.3-inch display (when 2-dial type is displayed)

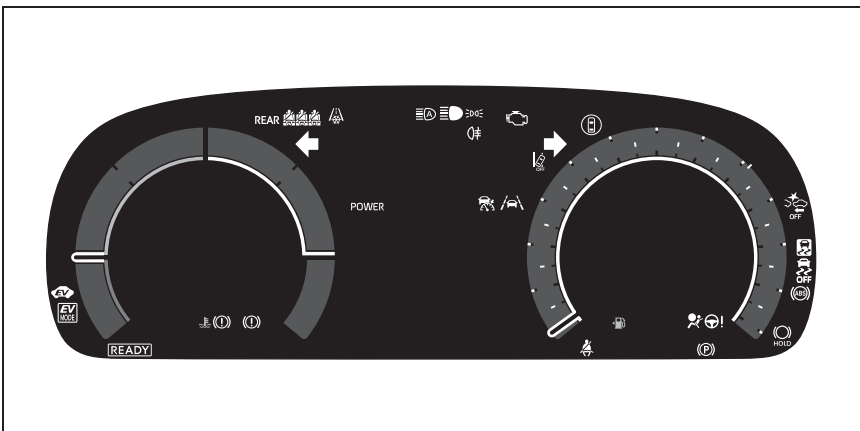

Warning lights

Warning lights inform the driver of malfunctions in the indicated vehicle's systems.



Brake system warning light*¹
(→P.298)



Brake system warning light*¹
(→P.298)



High coolant temperature warning light*² (→P.298)



Hybrid system overheat warning light*² (→P.299)



Charging system warning light*¹ (→P.299)



Low engine oil pressure warning light*² (→P.299)



Malfunction indicator lamp*¹
(→P.299)



SRS warning light*¹ (→P.299)



ABS warning light*¹ (→P.300)



Inappropriate pedal operation warning light*² (→P.300)



Electric power steering system warning light*¹ (→P.300)
(Red/yellow)



Low fuel level warning light
(→P.300)



Driver's and front passenger's seat belt reminder light
(→P.301)



*³

Rear passengers' seat belt reminder lights
(→P.301)



*⁴



PCS warning light*¹ (→P.302)



LTA indicator (→P.302)
(Orange)



LDA indicator (→P.302)
(Orange)



Dynamic radar cruise control indicator (→P.302)
(Orange)



Cruise control indicator
(→P.302)
(Orange)



Driving assist information indicator*¹ (→P.303)



Slip indicator*¹ (→P.303)



Parking brake indicator
(→P.303)
(Flashes)



Brake hold operated indicator*¹ (→P.304)
(Flashes)

*¹: These lights come on when the power switch is turned to ON to indicate that a system check is being performed. They will turn off after the hybrid system is on, or after a few seconds. There may be a malfunction in a system if the lights do not come on, or turn off. Have the vehicle inspected by your Toyota dealer.

*²: This light illuminates on the

multi-information display.

*3: 12.3-inch display.

*4: 7-inch display or 12.3-inch display.









WARNING

















■ If a safety system warning light does not come on

Should a safety system warning light such as the ABS and SRS warning light not come on when you start the hybrid system, this could mean that these systems are not available to help protect you in an accident, which could result in death or serious injury. Have the vehicle inspected by your Toyota dealer immediately if this occurs.

Indicators

The indicators inform the driver of the operating state of the vehicle's various systems.

-  Turn signal indicator (→P.148)
-  Tail light indicator (→P.154)
-  Headlight high beam indicator (→P.155)
-  Automatic High Beam indicator (→P.156)
-  Rear fog light indicator (→P.159)
-  PCS warning light*^{1, 2} (→P.172)
-  Dynamic radar cruise control indicator (→P.198)
-  Cruise control indicator (→P.198)

-  LDA indicator (→P.189)
(Green/Orange [Flashes])
-  LDA OFF indicator (→P.189)
(Orange)
-  LTA indicator (→P.184)
(Green/White/Orange [Flashes])
-  BSM outside rear view mirror indicators*^{1, 3} (if equipped) (→P.207)
-  Driving assist information indicator*^{1, 2} (→P.303)
-  Slip indicator*¹ (→P.222)
(Flashes)
-  VSC OFF indicator*^{1, 2} (→P.222)
-  Smart entry & start system indicator*⁴ (→P.140)
-  "READY" indicator (→P.140)
-  EV drive mode indicator (→P.144)
-  Parking brake indicator (→P.149)
-  Brake hold standby indicator*¹ (→P.152)
-  Brake hold operated indicator*¹ (→P.152)
-  EV indicator (→P.59)
-  Low outside temperature indicator*⁵ (→72, 75)
-  Security indicator*⁶ (→P.66)

ECOEco drive mode indicator
(→P.220)**POWER**Power mode indicator
(→P.220)

- *1: These lights come on when the power switch is turned to ON to indicate that a system check is being performed. They will turn off after the hybrid system is started, or after a few seconds. There may be a malfunction in a system if the lights do not come on, or turn off. Have the vehicle inspected by your Toyota dealer.
- *2: This light comes on when the system is turned off.
- *3: This light illuminates on the outside rear view mirrors.
- *4: This light illuminates on the multi-information display.
- *5: When the outside temperature is approximately 3°C (37°F) or lower, this indicator will flash for approximately 10 seconds, then stay on.
- *6: This light illuminates on the center panel.

Gauges and meters (7-inch display)

Meter display

■ Locations of gauges and meters

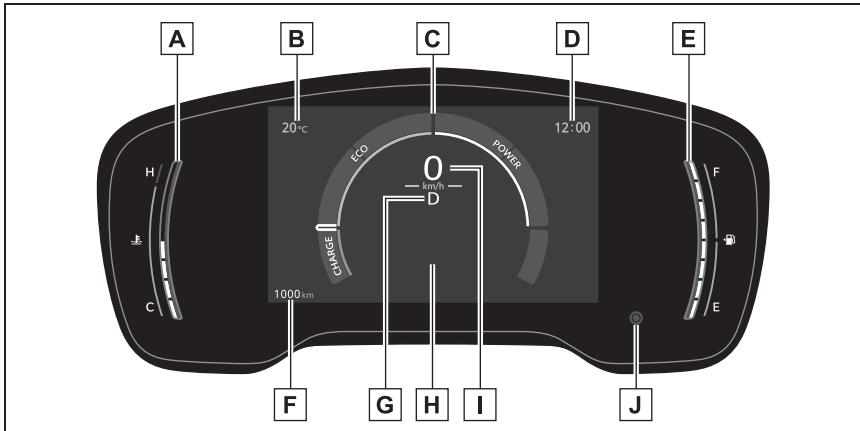

A Engine coolant temperature gauge

Displays the engine coolant temperature

B Outside temperature

Displays the outside temperature within the range of -40°C (-40°F) to 60°C (140°F)

C Hybrid System Indicator/Speedometer/Tachometer

Displays hybrid system output or regeneration level (→P.72)

This setting can be changed on the setting screen. (→P.346)

D Clock (→P.74)

E Fuel gauge

Displays the quantity of fuel remaining in the tank

F Odometer and trip meter display (→P.74)

G Shift position indicator (→P.146)

H Multi-information display

Presents the driver with a variety of vehicle data (→P.80)

Displays warning messages if a malfunction occurs (→P.305)

I Speedometer

J Display change button (→P.74)

■ Hybrid System Indicator

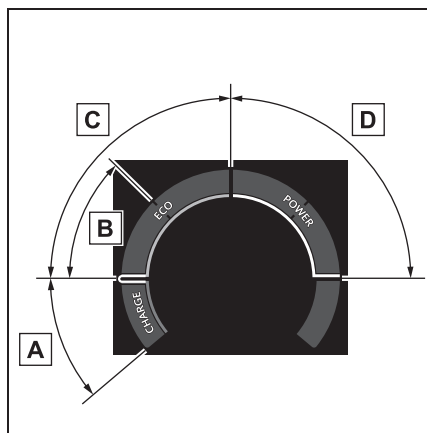

A Charge area

Shows regeneration* status.

Regenerated energy will be used to charge the hybrid battery (traction battery).

B Hybrid Eco area

Shows that gasoline engine power is not being used very often.

The gasoline engine will automatically stop and restart under various conditions.

C Eco area

Shows that the vehicle is being driven in an Eco-friendly manner.

By keeping the bar display within Eco area, more Eco-friendly driving can be achieved.

D Power area

Shows that an Eco-friendly driving range is being exceeded (during full power driving etc.)

*: When used in this manual, regeneration refers to the conversion of energy created by the movement of the vehicle into electrical energy.

■ Engine speed

On hybrid electric vehicles, engine speed is precisely controlled in order to help improve fuel efficiency and reduce exhaust emissions etc.

There are times when the engine speed that is displayed may differ even when vehicle operation and driving conditions are the same.

■ Hybrid System Indicator will operate when

The Hybrid System Indicator will operate in the following situations:

- The “READY” indicator is illuminated.
- The shift lever is in D or B.

■ Outside temperature display

● In the following situations, the correct outside temperature may not be displayed, or the display may take longer than normal to change:

- When stopped, or driving at low speeds (less than 20 km/h [12 mph])
- When the outside temperature has changed suddenly (at the entrance/exit of a garage, tunnel, etc.)
- When “-” or “E” is displayed, the system may be malfunctioning. Take your vehicle to your Toyota dealer.

■ Liquid crystal display

→P.81

■ Customization

The gauges and meters can be customized in  of the multi-information display. (→P.346)

⚠ WARNING

■ The information display at low temperatures

Allow the interior of the vehicle to warm up before using the liquid crystal information display. At extremely low temperatures, the information display monitor may respond slowly, and display changes may be delayed.

**WARNING**

For example, there is a lag between the driver's shifting and the new gear number appearing on the display. This lag could cause the driver to downshift again, causing rapid and excessive engine braking and possibly an accident resulting in death or injury.

**NOTICE**

■ **To prevent damage to the engine and its components**

- Do not let the indicator needle of the tachometer enter the red zone, which indicates the maximum engine speed.
- The engine may be overheating if the engine coolant temperature gauge is in the red zone (H). In this case, immediately stop the vehicle in a safe place, and check the engine after it has cooled completely. (→P.333)

Odometer and trip meter display

■ Changing the display

Press the display change button until the desired item is displayed.

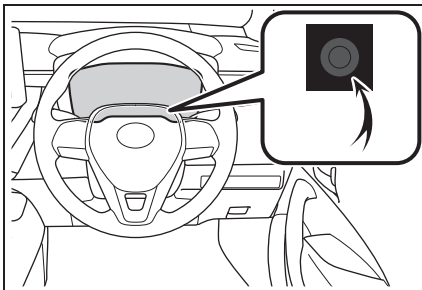

■ Display items

- Odometer

Displays the total distance the vehicle has been driven.

- Trip meter A/Trip meter B

Displays the distance the vehicle has been driven since the meter was last reset. Trip meters A and B can be used to record and display different distances independently.

To reset, display the desired trip meter and press and hold the display change button.

- Instrument panel light control

Displays the instrument panel light control display.

- The brightness of the instrument panel lights can be adjusted separately for when the tail lights are on and off.
- To adjust the brightness, display the instrument panel light control display and press and hold the display change button.

Adjusting the clock

- **The clocks can be adjusted on the audio system screen.**

Refer to "Multimedia Owner's Manual".

Gauges and meters (12.3-inch display)

Meter display

■ Locations of gauges and meters

▶ 2-dial display

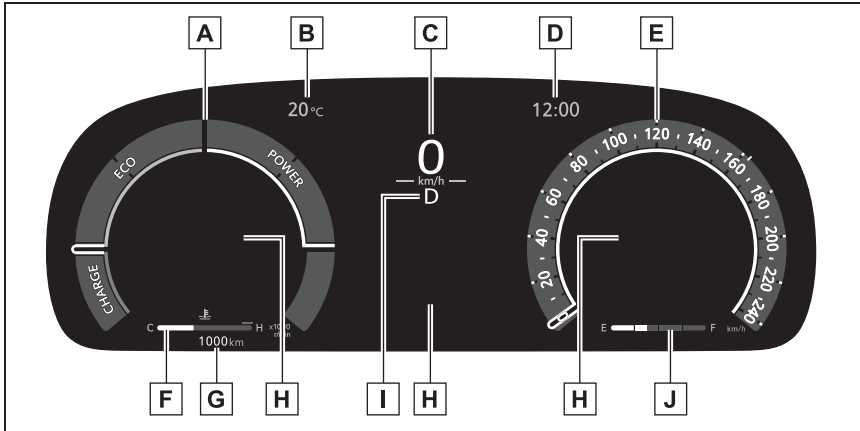

A Hybrid System Indicator/Tachometer

Displays hybrid system output or regeneration level (→P.78)

This setting can be changed on the setting screen. (→P.346)

B Outside temperature

Displays the outside temperature within the range of -40°C (-40°F) to 60°C (140°F)

C Speedometer

D Clock (→P.80)

E Speedometer

F Engine coolant temperature gauge

Displays the engine coolant temperature

G Odometer and trip meter display (→P.79)

H Multi-information display

Presents the driver with a variety of vehicle data (→P.86)

Displays warning messages if a malfunction occurs (→P.305)

I Shift position indicator (→P.146)

J Fuel gauge

Displays the quantity of fuel remaining in the tank

▶ 1-dial display

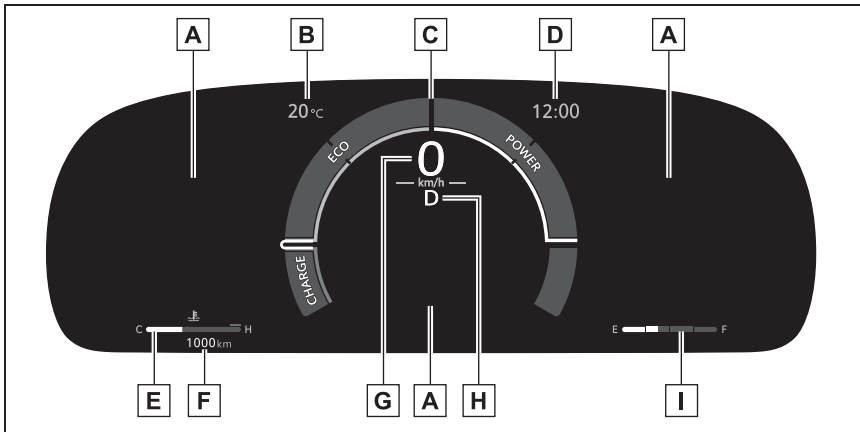
**A** Multi-information display

Presents the driver with a variety of vehicle data (→P.86)

Displays warning messages if a malfunction occurs (→P.305)

B Outside temperature

Displays the outside temperature within the range of -40°C (-40°F) to 60°C (140°F)

C Hybrid System Indicator/Speedometer/Tachometer

Hybrid System Indicator: Displays hybrid system output or regeneration level (→P.78)

This setting can be changed on the setting screen. (→P.346)

D Clock (→P.80)**E** Engine coolant temperature gauge

Displays the engine coolant temperature

F Odometer and trip meter display (→P.79)**G** Speedometer**H** Shift position indicator (→P.146)**I** Fuel gauge

Displays the quantity of fuel remaining in the tank

► Non-dial display

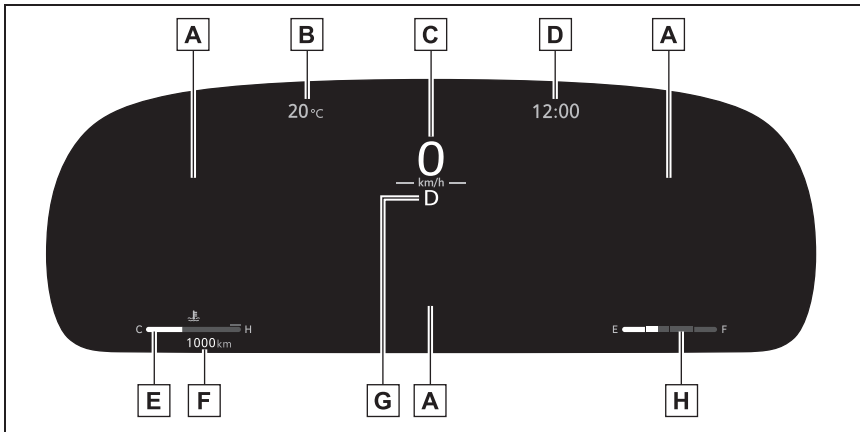
**A** Multi-information display

Presents the driver with a variety of vehicle data (→P.86)

Displays warning messages if a malfunction occurs (→P.305)

B Outside temperature

Displays the outside temperature within the range of -40°C (-40°F) to 60°C (140°F)

C Speedometer**D** Clock (→P.80)**E** Engine coolant temperature gauge

Displays the engine coolant temperature

F Odometer and trip meter display (→P.79)**G** Shift position indicator (→P.146)**H** Fuel gauge

Displays the quantity of fuel remaining in the tank

■ Hybrid System Indicator

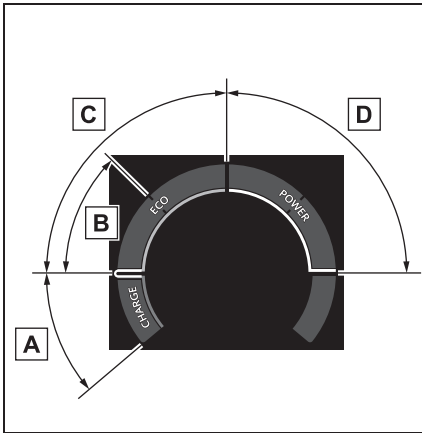

A Charge area

Shows regeneration* status.

Regenerated energy will be used to charge the hybrid battery (traction battery).

B Hybrid Eco area

Shows that gasoline engine power is not being used very often.

The gasoline engine will automatically stop and restart under various conditions.

C Eco area

Shows that the vehicle is being driven in an Eco-friendly manner.

By keeping the bar display within Eco area, more Eco-friendly driving can be achieved.

D Power area

Shows that an Eco-friendly driving range is being exceeded (during full power driving etc.)

*: When used in this manual, regeneration refers to the conversion of energy created by the movement of the vehicle into electrical energy.

■ Engine speed

On hybrid electric vehicles, engine speed is precisely controlled in order to help improve fuel efficiency and reduce exhaust emissions etc.

There are times when the engine speed that is displayed may differ even when vehicle operation and driving conditions are the same.

■ Hybrid System Indicator will operate when

The Hybrid System Indicator will operate in the following situations:

- The “READY” indicator is illuminated.
- The shift lever is in D or B.

■ Outside temperature display

● In the following situations, the correct outside temperature may not be displayed, or the display may take longer than normal to change:

- When stopped, or driving at low speeds (less than 20 km/h [12 mph])
- When the outside temperature has changed suddenly (at the entrance/exit of a garage, tunnel, etc.)
- When “-” or “E” is displayed, the system may be malfunctioning. Take your vehicle to your Toyota dealer.

■ Liquid crystal display

→P.86

■ Free/Open Source Software Information

This product contains Free/Open Source Software (FOSS). The license information and/or the source code of such FOSS can be found at the following URL.

<https://www.denso.com/global/en/opensource/meter/toyota/>

■ Customization

The gauges and meters can be customized in  of the multi-information display. (→P.346)

**WARNING****■ The information display at low temperatures**

Allow the interior of the vehicle to warm up before using the liquid crystal information display. At extremely low temperatures, the information display monitor may respond slowly, and display changes may be delayed.

For example, there is a lag between the driver's shifting and the new gear number appearing on the display. This lag could cause the driver to downshift again, causing rapid and excessive engine braking and possibly an accident resulting in death or injury.

**NOTICE****■ To prevent damage to the engine and its components**

- Do not let the indicator needle of the tachometer enter the red zone, which indicates the maximum engine speed.
- The engine may be overheating if the engine coolant temperature gauge is in the red zone (H). In this case, immediately stop the vehicle in a safe place, and check the engine after it has cooled completely. (→P.333)

Odometer and trip meter display**■ Changing the display**

Each time the "ODO TRIP" switch is pressed, the displayed item will be changed. When the trip meter is displayed, pressing and holding the switch will reset the trip meter.

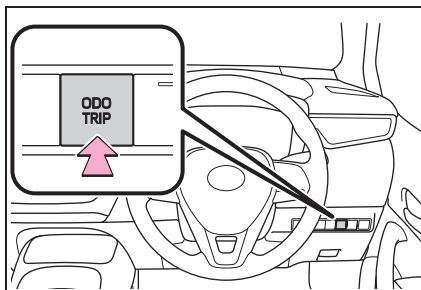
**■ Display items****● Odometer**

Displays the total distance the vehicle has been driven.



● Trip meter A/Trip meter B

Displays the distance the vehicle has been driven since the meter was last reset. Trip meters A and B can be used to record and display different distances independently.

To reset, display the desired trip meter and press and hold the "ODO TRIP" switch.

Changing the meter light brightness

The brightness of the meter light can be changed on  of the multi-information display.

- 1 Select  of the multi-information display.
- 2 Press the  or  meter control switch to select "Adjust Meter Brightness".
- 3 Press and hold the OK meter control switch.

- 4 Press **<** or **>** to adjust the brightness.

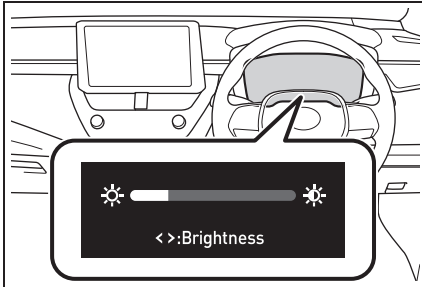

Adjusting the clock

- The clocks can be adjusted on the audio system screen.

Refer to “Multimedia Owner's Manual”.

Multi-information display (7-inch display)

Display and menu icons

■ Display

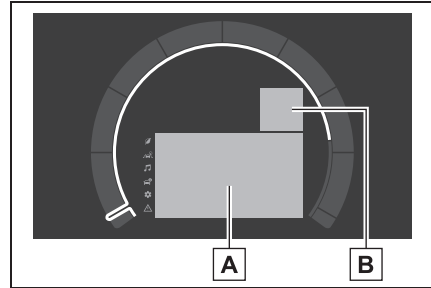

A Content display area

By selecting menu icons on the multi-information display, a variety of driving-related information can be displayed. The multi-information display can also be used to change display settings and other vehicle settings.

Warning or advice pop-up displays are also displayed in certain situations.

B Driving support system status display area







Displays an image when the following systems are operating and a menu icon

other than  is selected:

- LTA (Lane Tracing Assist)
- LDA (Lane Departure Alert)
- Dynamic radar cruise control

■ Menu icons

The menu icons will be displayed by pressing the **^** or **v** meter control switch.

-  Driving information display
(→P.81)
-  Driving support system information display (→P.84)
-  Audio system-linked display
(→P.84)
-  Vehicle information display
(→P.84)
-  Settings display (→P.85)
-  Warning message display
(→P.305)

■ Liquid crystal display

Small spots or light spots may appear on the display. This phenomenon is characteristic of liquid crystal displays, and there is no problem continuing to use the display.

WARNING

■ Caution for use while driving

- When operating the multi-information display while driving, pay extra attention to the safety of the area around the vehicle.
- Do not look continuously at the multi-information display while driving as you may fail to see pedestrians, objects on the road, etc. ahead of the vehicle.



■ The information display at low temperatures

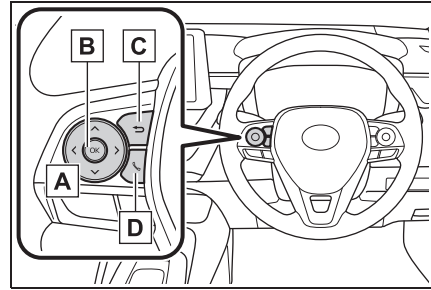

→P.73

Changing the meter display

The multi-information display is operated using the meter control switches.



- A**   : Select menu icons, scroll the screen and move the cursor

  : Change displayed content, scroll the screen and move the cursor
- B** Press: Enter/Set
Press and hold: Reset/Display customizable items
- C** Return to the previous screen
- D** Call sending/receiving and history display

Linked with the hands-free system, sending or receiving call is displayed. For details regarding the hands-free system, refer to the "Multimedia Owner's Manual".

Content of driving information

■ Display items

- Fuel economy
- ECO Accelerator Guidance/Eco score
- EV driving ratio

■ Fuel economy

Use the displayed values as a refer-

ence only.



A Current fuel consumption

Displays instantaneous current fuel consumption.

B Average fuel economy (after reset)

To reset the average fuel economy display, press and hold the OK meter control switch.

The average fuel economy display can be changed in . (→P.84)

- Average fuel economy (after start)

Displays the average fuel consumption since hybrid system start.

- Average fuel economy (after refuel)

Displays the average fuel consumption since the vehicle was refueled.

■ ECO Accelerator Guidance/Eco score

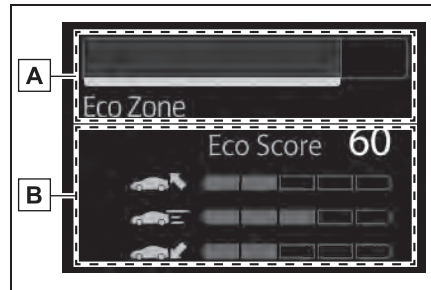

A ECO Accelerator Guidance

B Eco score

- ECO Accelerator Guidance

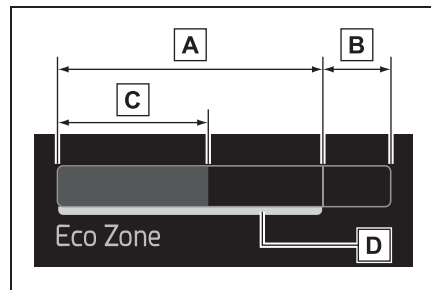

A Eco area

Indicates that the vehicle is being driven in an Eco-friendly manner.

B Power area

Indicates that the Eco-friendly driving range is being exceeded (during full power driving, etc.)

C Current accelerator pedal operation

Displayed as a green bar when within the Eco area.

Eco-friendly acceleration can be achieved by keeping the accelerator pedal operation display within the range indicated by the blue bar. (→P.133)

D Zone of Eco acceleration

Displayed as a blue bar, and represents an estimated suitable accelerator pedal operation range for the current driving conditions, such as starting off or cruising.

This display changes according to situation, such as when starting off or cruising.

● Eco score

The following 3 Eco driving methods are evaluated in 5 levels: Smooth start-off acceleration, driving without sudden acceleration, and smooth stopping. When the vehicle is stopped, an Eco score out of 100 points will be displayed.

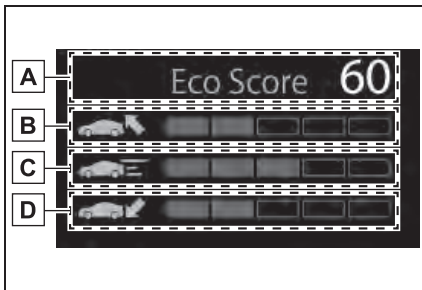

A Score result

B Eco start status

C Eco cruise status

D Eco stop status

How to read the bar display

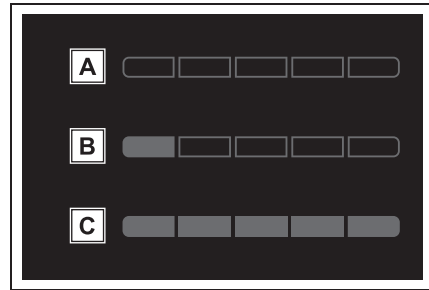

A Not yet evaluated

B Low

C High

- After the hybrid system is started, the Eco score will not be displayed until the vehicle speed exceeds approximately 30 km/h (19 mph).
- The Eco score will be reset each time the hybrid system is started.

■ EV Ratio/EV Driving Ratio

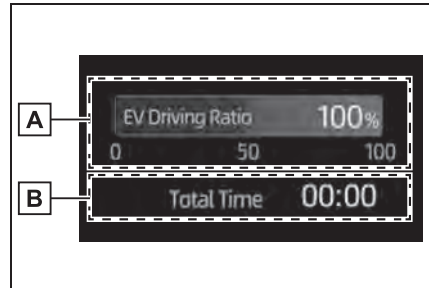

A EV driving ratio after starting

Displays the percentage of EV driving since the hybrid system was started.*

B Elapsed time after starting

Displays the elapsed time since hybrid system was started.*

*: It is reset each time the hybrid system stops.

■ The ECO Accelerator Guidance/Eco score will not operate when

The ECO Accelerator Guidance/Eco score will not operate in the following situations:

- The Hybrid System Indicator is not operating.
- The vehicle is being driven using the cruise control or dynamic radar cruise control.

Driving support system information display

■ Driving support system information

Select to display the operational status of the following systems:

- LTA (Lane Tracing Assist) (→P.181)
- LDA (Lane Departure Alert) (→P.186)
- Dynamic radar cruise control (→P.195)

■ Navigation system-linked display (if equipped)

Select to display the following navigation system-linked information:

- Route guidance to destination
- Compass display (heading-up display)

Audio system-linked display

Select to enable selection of an audio source or track on the meter using the meter control switches.

This menu icon can be set to be dis-

played/not displayed in .

Vehicle information display

■ Display items

- Drive information
- Energy monitor (→P.97)

■ Drive information

Displays drive information such as the following:

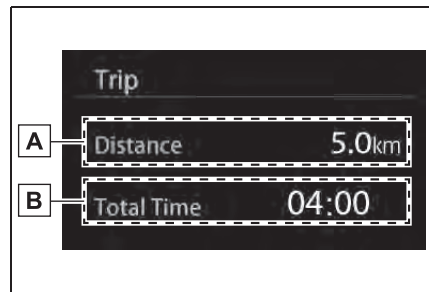

A Drive information 1

B Drive information 2

Displays the following depending on which drive information type and drive information items were

selected in . (→P.85)

- After start
 - Distance: Displays the distance driven since hybrid system start
 - Elapsed time: Displays the elapsed time since hybrid system start
 - Average vehicle speed: Displays the average vehicle speed since hybrid system start
- After reset
 - Distance: Displays the distance driven since the display was reset*
 - Elapsed time: Displays the elapsed

time since the display was reset*

- Average vehicle speed: Displays the average vehicle speed since the display was reset*

*: To reset, display the desired item and press and hold the OK meter control switch.

Settings display

■ Meter display settings that can be changed

- Language

Select to change the language displayed.

- Units

Select to change the units of measure displayed.

- Meter Type

Select to change the meter type.

- Dial Type

Select to change the display of the speedometer, tachometer or Hybrid System Indicator.

- EV indicator

Select to enable/disable the EV indicator.



- Fuel economy display

Select to change the average fuel consumption display to any of the following: trip average/total average/tank average. (→P.81)

- Hybrid system display

Select to display/not display the zone of Eco acceleration of the Eco Accelerator Guidance. (→P.82)



Select to display/not display the audio system linked display.



Select to change the displayed content of the following:

- Display contents

Select to display/not display the energy monitor. (→P.97)

- Drive information type

Select to change the drive information type display between trip information/total information.

- Drive information items

Select to set the first and second items of the drive information display to any of the following: average vehicle speed/distance/elapsed time.

- Pop-up display

Select to enable/disable pop-up displays for each relevant system.

- Multi-information display off

Select to turn the multi-information display off.

To turn the multi-information display on again, press any of the following meter control switches

^ / v / < / > / OK / ↵.

- Default setting

Select to reset the meter display settings to the default setting.

■ Vehicle functions and settings that can be changed

→P.346

■ Suspension of the settings display

- Some settings cannot be changed

while driving. When changing settings, park the vehicle in a safe place.

- If a warning message is displayed, operation of the settings display will be suspended.



WARNING

■ Cautions during setting up the display

If the hybrid system is operating while changing certain settings on the settings display, ensure that the vehicle is parked in a place with adequate ventilation. In a closed area such as a garage, exhaust gases including harmful carbon monoxide (CO) may collect and enter the vehicle. This may lead to death or a serious health hazard.



NOTICE

■ During setting up the display

To prevent 12-volt battery discharge, ensure that the hybrid system is operating while setting up the display features.

Multi-information display (12.3-inch display)

Display

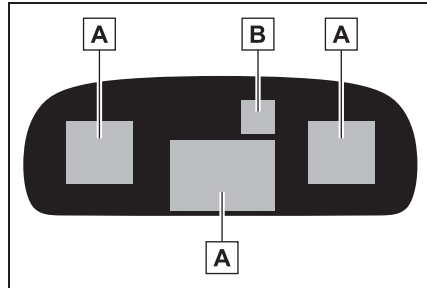

A Content display area

By selecting menu icons on the multi-information display, a variety of driving-related information can be displayed. The multi-information display can also be used to change display settings and other vehicle settings.

Warning or advice pop-up displays are also displayed in certain situations.

B Driving support system status display area

Displays a contracted display of the driving support system status when not selected for the multi-information display, while any of the following systems are operating:

- LTA (Lane Tracing Assist)
- LDA (Lane Departure Alert)
- Dynamic radar cruise control

■ Liquid crystal display

Small spots or light spots may appear on the display. This phenomenon is characteristic of liquid crystal displays, and there is no problem continuing to use the display.

⚠ WARNING

■ Caution for use while driving

- When operating the multi-information display while driving, pay extra attention to the safety of the area around the vehicle.
- Do not look continuously at the multi-information display while driving as you may fail to see pedestrians, objects on the road, etc. ahead of the vehicle.

■ The information display at low temperatures

→P.79

Changing the meter display

■ Meter control switch

The multi-information display is operated using the meter control switches.

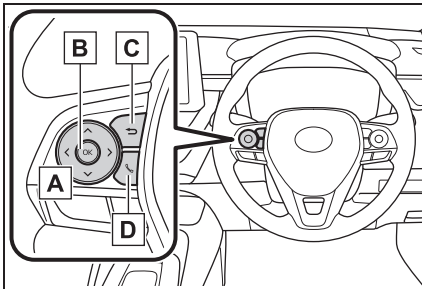

A < / > : Select multi-information display

^ / v : Change displayed content, scroll up/down the screen and move the cursor up/down

B Press: Enter/Set
Press and hold: Reset/Display customizable items

C Return to the previous screen

D Call sending/receiving and history display

Linked with the hands-free system, sending or receiving call is displayed. For details regarding the hands-free system, refer to the "Multimedia Owner's Manual".

■ Changing meter pages

Press the < or > meter control switch to change the meter page.

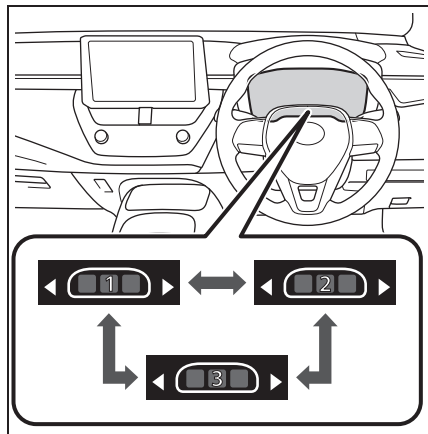

Content of multi-information display (Center)

■ Display contents

- Driving support system information display
- Navigation system-linked display (if equipped)
- Settings
- Warning message (→P.305)

■ Changing contents in a page

Select the desired content on the page's setting mode display.

- 1 Press the < or > meter control switch to select a page.
- 2 To enable page edit, press and hold the OK meter control switch.
- 3 Press the < or > meter control switch to select a display to be changed.
- 4 Press ^ or v meter control switch to select a content.
- 5 When the setting is complete, press ↵.

■ Driving support system information display

Select to display the operational status of the following systems:

- LTA (Lane Tracing Assist)
(→P.181)
- LDA (Lane Departure Alert)
(→P.186)
- Dynamic radar cruise control
(→P.195)

■ Navigation system-linked display (if equipped)

Select to display the following navigation system-linked information:

- Route guidance to destination
- Compass display (heading-up display)

■ Settings

The meter display settings can be changed in .

● Language

Select to change the language displayed.

● Units

Select to change the units of measure displayed.

● Meter Type

Select to change the meter type.

● Meter Style

Select to change the meter style.

● Dial Type

1 dial: Select to change the display of the speedometer, tachometer or Hybrid System Indicator.

2 dial: Select to change the left side dial of the Hybrid System Indicator or tachometer.

● EV indicator

Select to enable/disable the EV indicator.

● Fuel Economy

Select to set the display of the fuel economy.

● Hybrid System

Select to set the display of the zone of Eco acceleration.

● TRIP A/B Items

Select to change the display of the drive information of TRIP A/B.

● Pop-up display

Select to enable/disable pop-up displays for each relevant system.

● Default settings

Select to reset the meter display settings to the default setting.

Content of multi-information display (Side)

■ Display contents (Side)

- Fuel economy
- ECO Accelerator Guidance/Eco score
- EV Driving Ratio/Elapsed time after starting
- Driving support system information display
- Navigation system-linked display
- Audio system-linked display
- Drive information
- Drive information of Trip A/B
- Energy monitor (→P.97)

Changing items to be displayed on the side multi-information displays. (→P.89)

■ Changing contents in a page

→P.87

■ Changing contents to be displayed on the side multi-information displays

- 1 Press the < or > meter control switch to select a page.
- 2 To enable page edit, press and hold the OK meter control switch.
- 3 Press the < or > meter control switch to select the desired side multi-information display to be changed.

- 4 Press the < or > meter control switch for the side that (☰) is displayed to move to a content list screen that enables to select display/not display each items.
- 5 Press ^ or v control switch to select a content and select OK to set for display/not display the item.

■ Fuel economy

Use the displayed values as a reference only.

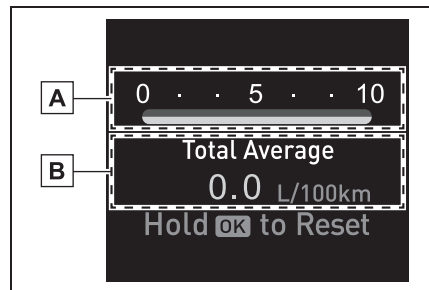

A Current fuel consumption

Displays instantaneous current fuel consumption.

B Average fuel economy (after reset)

The average fuel economy display can be changed in ⚙️. (→P.92)

● Average fuel economy (after start)

Displays the average fuel consumption since hybrid system start.

● Average fuel economy (after reset)

Displays average fuel consumption

since display was reset.

To reset the average fuel economy display, press and hold the OK meter control switch.

■ **ECO Accelerator Guidance/Eco score**

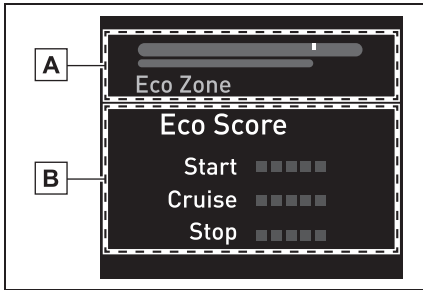

A ECO Accelerator Guidance

B Eco score

- ECO Accelerator Guidance

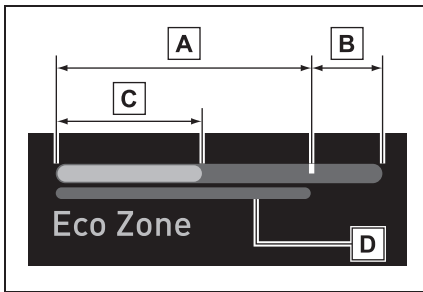

A Eco area

Indicates that the vehicle is being driven in an Eco-friendly manner.

B Power area

Indicates that the Eco-friendly driving range is being exceeded (during full power driving, etc.)

C Current accelerator pedal operation

Displayed as a green bar when within

the Eco area.

Eco-friendly acceleration can be achieved by keeping the accelerator pedal operation display within the range indicated by the blue bar. (→P.133)

D Zone of Eco acceleration

Displayed as a blue bar, and represents an estimated suitable accelerator pedal operation range for the current driving conditions, such as starting off or cruising.

This display changes according to situation, such as when starting off or cruising.

- Eco score

The following 3 Eco driving methods are evaluated in 5 levels: Smooth start-off acceleration, driving without sudden acceleration, and smooth stopping. When the vehicle is stopped, an Eco score out of 100 points will be displayed.

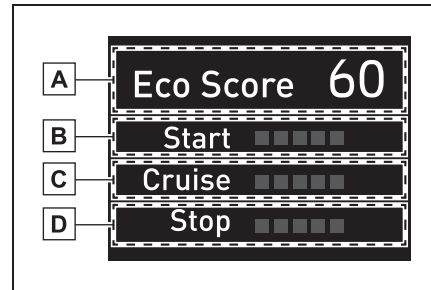

A Score result

B Eco start status

C Eco cruise status

D Eco stop status

How to read the bar display

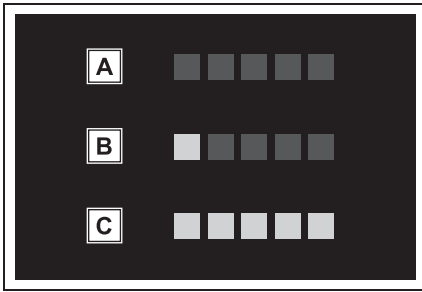

A Not yet evaluated

B Low

C High

- After the hybrid system is started, the Eco score will not be displayed until the vehicle speed exceeds approximately 30 km/h (19 mph).
- The Eco score will be reset each time the hybrid system is started.

■ EV Driving Ratio/Elapsed time after starting

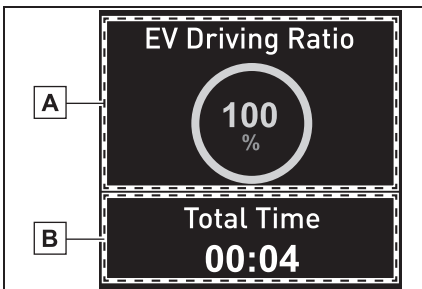

A EV driving ratio after starting

Displays the percentage of EV driving since the hybrid system was started.*

B Elapsed time after starting

Displays the elapsed time since hybrid system was started.*

*: It is reset each time the hybrid system stops.

■ Driving support system information display

Select to display the operational status of the following systems:

- LTA (Lane Tracing Assist)
(→P.181)
- LDA (Lane Departure Alert)
(→P.186)
- Dynamic radar cruise control
(→P.195)

■ Navigation system-linked display (if equipped)

Select to display the following navigation system-linked information:

- Route guidance to destination
- Compass display (heading-up display)

■ Audio system-linked display

Displays the audio source or track.

■ Drive information

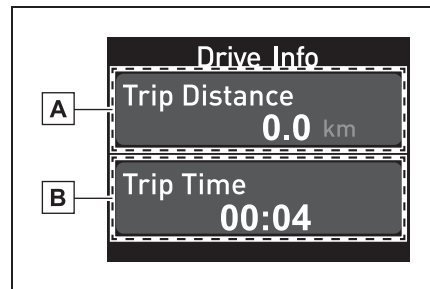

A Drive information 1

B Drive information 2

Displays the following depending on which drive information type and drive information items were

selected in . (→P.92)

- Average speed: Displays the average vehicle speed since hybrid system start
- Trip distance: Displays the distance driven since hybrid system start
- Trip time: Displays the elapsed time since hybrid system start

■ Drive information of TRIP A/B

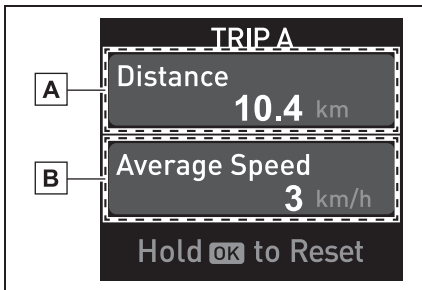

A Drive information of trip A/B 1

B Drive information of trip A/B 2

Displays the following depending on which drive information type and drive information items were selected in . (→P.92)

- Average speed: Displays the average vehicle speed of trip A/B
- Trip distance: Displays the distance driven of trip A/B
- Trip time: Displays the elapsed time of trip A/B

■ The ECO Accelerator Guidance/Eco score will not operate when

The ECO Accelerator Guidance/Eco score will not operate in the following situations:

- The Hybrid System Indicator is not operating.

- The vehicle is being driven using the cruise control or dynamic radar cruise control.

Settings display

■ Vehicle functions and settings that can be changed

→P.346

■ Meter display settings

→P.88

■ Suspension of the settings display

- Some settings cannot be changed while driving. When changing settings, park the vehicle in a safe place.
- If a warning message is displayed, operation of the settings display will be suspended.

WARNING

■ Cautions during setting up the display

If the hybrid system is operating while changing certain settings on the settings display, ensure that the vehicle is parked in a place with adequate ventilation. In a closed area such as a garage, exhaust gases including harmful carbon monoxide (CO) may collect and enter the vehicle. This may lead to death or a serious health hazard.

NOTICE

■ During setting up the display

To prevent 12-volt battery discharge, ensure that the hybrid system is operating while setting up the display features.

Head-up display*

*: If equipped

The head-up display projects a variety of driving-related information and the operating state of the driving support systems on the windshield.

System components

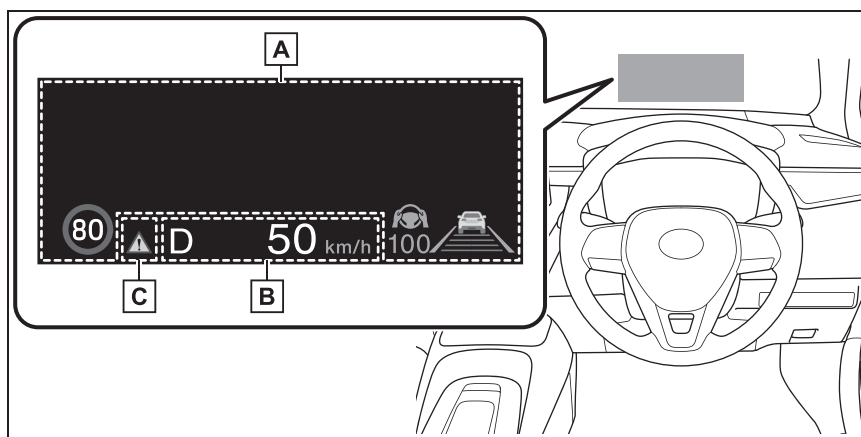

Illustrations used in this text are intended as examples, and may differ from the image that is actually displayed by the head-up display.

A Main display area

Displays the following items:

- Driving support system information display
- Hybrid System Indicator/tachometer
- RSA (Road Sign Assist) display
- Compass (vehicles with navigation system)

B Driving information display area

Displays the following items:

- Speedometer
- Shift position

C : Master warning icon

Displayed when a warning message is displayed.

■ Head-up display will operate when

The power switch is in ON.

■ When using the head-up display

The head-up display may seem dark or hard to see when viewed through sun-

glasses, especially polarized sunglasses. Adjust the brightness of the head-up display or remove your sunglasses.

■ **Street name display (vehicles with navigation system)**

Only street names which are included in the map data will be displayed.



WARNING

■ **When using the head-up display**

- Check that the position and brightness of the head-up display image does not interfere with safe driving. Incorrect adjustment of the image's position or brightness may obstruct the driver's view and lead to an accident, resulting in death or serious injury.
- Do not continuously look at the head-up display while driving as you may fail to see pedestrians, objects on the road, etc. ahead of the vehicle.



NOTICE

■ **Head-up display projector**

- Do not place any drinks near the head-up display projector. If the projector gets wet, electrical malfunctions may result.

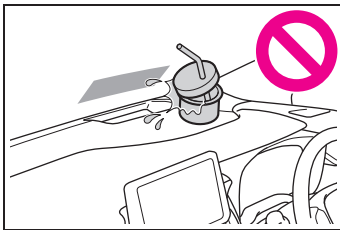

- Do not place anything on or put stickers onto the head-up display projector. Doing so could interrupt head-up display indications.

- Do not touch the inside of the head-up display projector or thrust sharp edges or the like into the projector. Doing so could cause mechanical malfunctions.

Using the head-up display

Select  on the multi-information display (→P.92) and then “HUD Main”.

■ **Enabling/disabling the head-up display**

Press the OK meter control switch to enable/disable the head-up display.

■ **Changing the head-up display settings**

Press and hold the OK meter control switch to change the following settings:

- Brightness and vertical position of the head-up display

Select to adjust the brightness or vertical position of the head-up display.

- Display content

Select to change the display between the following:

- Standard: →P.93
- Full: Driving support system information display is displayed large
- Minimum: Speedometer only
- Display angle

Select to adjust the angle of the

head-up display.

■ Enabling/disabling of the head-up display

If the head-up display is disabled, it will remain disabled when the power switch is turned off then back to ON.

■ Display brightness

The brightness of the head-up display can be adjusted on  of the multi-information display. Also, it is automatically adjusted according to the ambient brightness.



WARNING

■ Caution for changing settings of the head-up display

If the hybrid system is operating while changing certain settings on the settings display, ensure that the vehicle is parked in a place with adequate ventilation. In a closed area such as a garage, exhaust gases including harmful carbon monoxide (CO) may collect and enter the vehicle. This may lead to death or a serious health hazard.



NOTICE

■ When changing the settings of the head-up display

To prevent 12-volt battery discharge, ensure that the hybrid system is operating while changing the settings of the head-up display.

Driving assist system status/navigation system-linked display area (if equipped)

■ Driving assist system status display

Displays the operational status of the following systems:

- Dynamic radar cruise control (→P.195)
- LTA (Lane Tracing Assist) (→P.181)
- LDA (Lane Departure Alert) (→P.186)

Details of content displayed on the head-up display may differ from that displayed on the multi-information display. For details, refer to the explanation of each system.

■ Navigation system-linked display area (if equipped)

Displays the following items which are linked to the navigation system:

- Street name
- Route guidance to destination
- Compass (heading-up display)

Pop-up display

Pop-up displays for the following systems will be displayed when necessary:

■ Driving support systems

Displays a warning/suggestion/advice message or the operating state of a relevant system.

Details of content displayed on the head-up display may differ from that displayed on the multi-information display. For details, refer to the explanation of each system.

■ icon

Displayed when a warning message is displayed on the multi-information display. (→P.305)

■ Warning message

Some warning messages are displayed when necessary, according to certain conditions.

Details of content displayed on the head-up display may differ from that displayed on the multi-information display.

■ Audio system operation status

Displayed when an audio remote control switch on the steering wheel is operated.

■ Hands-free system status

Displayed when the hands-free system is operated.

■ When a pop-up display is displayed

When a pop-up display is displayed, a current display may no longer be displayed. In this case, the display will return after the pop-up display disappears.

Hybrid System Indicator/Tachometer/Outside temperature display

■ Hybrid System Indicator

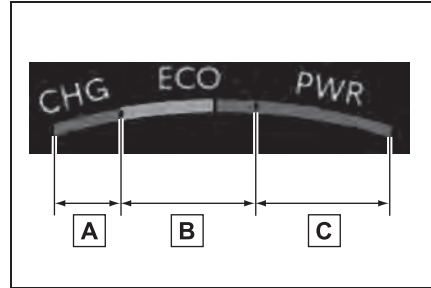

A Charge area

B Eco area

C Power area

Displayed content is the same as that displayed on the multi-information display (Hybrid System Indicator). For details, refer to P.78.

■ Tachometer

Displays the engine speed in revolutions per minute.

■ Outside temperature display

Displayed when the power switch is turned to ON or when the low outside temperature indicator is flashing.

■ Outside temperature display

- When the ambient temperature is approximately 3°C (37°F) or lower, the low outside temperature indicator will flash for approximately 10 seconds and the outside temperature display will turn off. In this case, the display will be displayed again when the outside temperature becomes approximately 5°C (41°F) or higher.

- In the following situations, the correct outside temperature may not be displayed, or the display may take longer than normal to change:
 - When stopped, or driving at low speeds (less than 20 km/h [12 mph])
 - When the outside temperature has changed suddenly (at the entrance/exit of a garage, tunnel, etc.)
- When “-” or “E” is displayed, the system may be malfunctioning. Take your vehicle to your Toyota dealer.

Energy monitor/consumption screen

You can view the status of your hybrid system on the multi-information display and the audio system screen.

System components

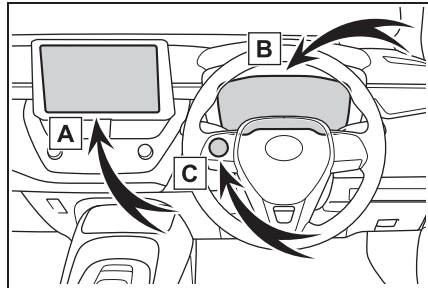

- A** Audio system screen
- B** Multi-information display
- C** Meter control switches (→P.81, 87)

Energy monitor

The energy monitor can be used to check the vehicle drive status, hybrid system operation status and energy regeneration status.

■ Display procedure

- ▶ Multi-information display (7-inch display)
 - 1 Select of  the multi-information display.

- 2 Press < or > to select “Energy Monitor” and then press and hold OK .

- ▶ Multi-information display (12.3-inch display)

- 1 Select of  the multi-information display and then press and hold OK .

- 2 Press ^ or v to select “Energy Monitor” and then press and hold OK .

- ▶ Audio system screen

- 1 Select  on the main menu.
- 2 Select “Energy flow”.

■ **Reading the display**

The arrows will appear in accordance with the energy flow. When there is no energy flow, arrows will not be displayed.

The color of the arrows will change as follows

Green or blue: When the hybrid battery (traction battery) is regenerated or charged.

Yellow or orange: When the hybrid battery (traction battery) is in use.

Red: When the gasoline engine is in use.

The image shows all the arrows as an example. The actual display will vary depending on conditions.

- ▶ Multi-information display (7-inch display)

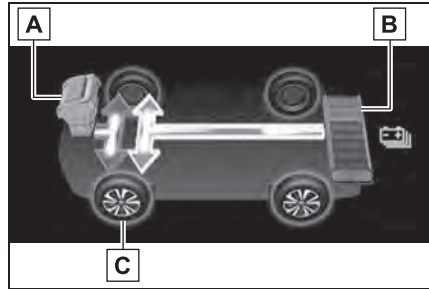

- A Gasoline engine
- B Hybrid battery (traction battery)
- C Tires

- ▶ Multi-information display (12.3-inch display)

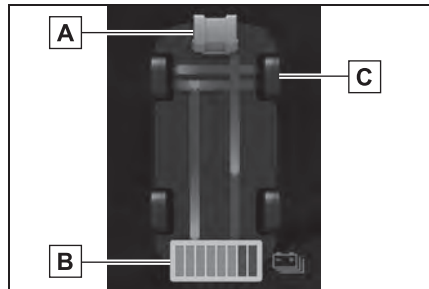

- A Gasoline engine
- B Hybrid battery (traction battery)
- C Tires

- ▶ Audio system screen

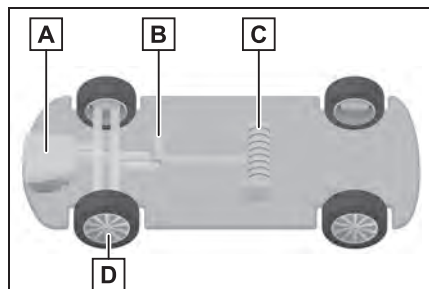

- A** Gasoline engine
- B** Front electric motor (traction motor)
- C** Hybrid battery (traction battery)
- D** Tires

■ Color of the hybrid battery (traction battery) on the audio system screen

It will be green when the hybrid battery (traction battery) is being charged, and yellow when the hybrid battery (traction battery) is being used.

■ Remaining charge amount warning of hybrid battery (traction battery)

- The buzzer sounds intermittently when the hybrid battery (traction battery) remains without charging while the shift lever is in N, or the remaining charge amount drops below a certain level. If the remaining charge amount drops further, the buzzer sounds continuously.
- When a warning message is shown on the multi-information display and the buzzer sounds, follow the instructions displayed on the screen to perform trouble shooting.

■ Hybrid battery (traction battery) status

- ▶ Multi-information display (7-inch display)

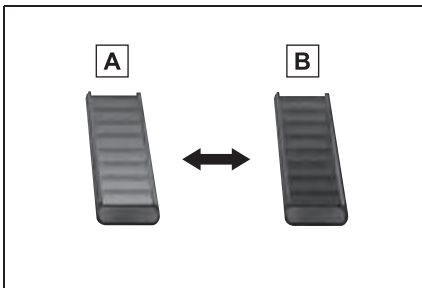

A Low

B High

These images are examples only, and may vary slightly from actual conditions.

- ▶ Multi-information display (12.3-inch display)

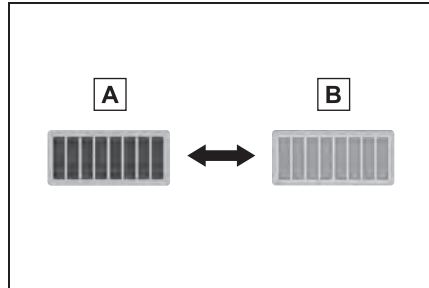

A Low

B High

These images are examples only, and may vary slightly from actual conditions.

- ▶ Audio system screen

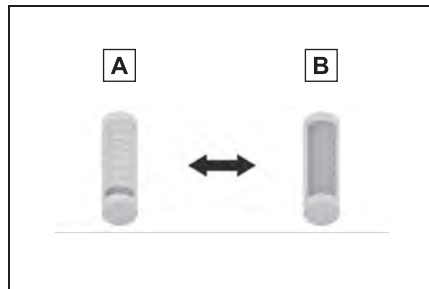

A Low

B High

Consumption

■ Trip information

- 1 Select  on the main menu.
- 2 Select “Trip information”.

If a screen other than “Current” is displayed, select “Current”.

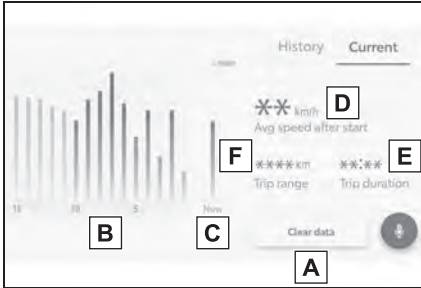

The image is an example only, and may vary slightly from actual conditions.

- A** Resetting the consumption data
- B** Fuel consumption in the past 15 minutes
- C** Current fuel consumption
- D** Average vehicle speed since the hybrid system was started.
- E** Elapsed time since the hybrid system was started.
- F** Cruising range

■ History

- 1 Select  on the main menu.
- 2 Select “Trip information”.

If a screen other than “History” is displayed, select “History”.

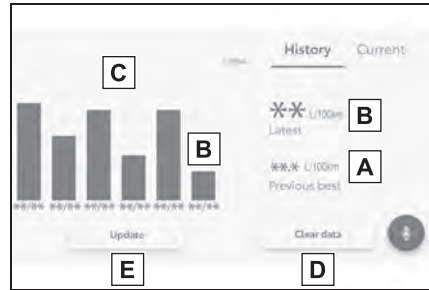

The image is an example only, and may vary slightly from actual conditions.

- A** Best recorded fuel consumption
- B** Latest fuel consumption
- C** Previous fuel consumption record
- D** Resetting the history data
- E** Updating the latest fuel consumption data

The average fuel consumption history is divided by color into past averages and the average fuel consumption since the last updated. Use the displayed average fuel consumption as a reference.

■ Updating the history data

Update the latest fuel consumption by selecting “Update” to measure the current fuel consumption again.

■ Resetting the data

The fuel consumption data can be deleted by selecting “Clear data”.

■ Cruising range

Displays the estimated maximum distance that can be driven with the quantity of fuel remaining.

This distance is computed based on your average fuel consumption. As a result, the actual distance that can be driven may differ from that displayed.

3-1. Key information	
Keys.....	102
3-2. Opening, closing and locking the doors	
Doors	105
Trunk.....	109
Smart entry & start system	111
3-3. Adjusting the seats	
Front seats.....	116
Rear seats	117
Head restraints	119
3-4. Adjusting the steering wheel and mirrors	
Steering wheel	121
Inside rear view mirror	122
Outside rear view mirrors	123
3-5. Opening and closing the windows	
Power windows.....	125
Moon roof	127
3-6. Favorite settings	
My Settings	130

Keys

The keys

The following keys are provided with the vehicle.

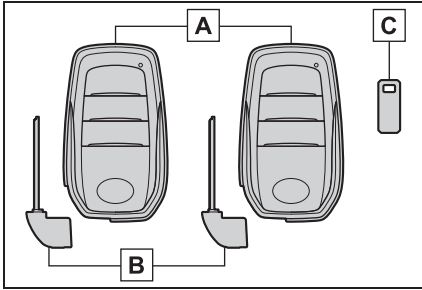

A Electronic keys

- Operating the smart entry & start system (→P.111)
- Operating the wireless remote control function (→P.103)

B Mechanical keys

C Key number plate

■ When riding in an aircraft

When bringing an electronic key onto an aircraft, make sure you do not press any buttons on the electronic key while inside the aircraft cabin. If you are carrying an electronic key in your bag, etc., ensure that the buttons are not likely to be pressed accidentally. Pressing a button may cause the electronic key to emit radio waves that could interfere with the operation of the aircraft.

■ Electronic key battery depletion

- The standard battery life is 1 to 2 years.
- If the battery becomes low, an alarm will sound in the cabin and a message will be shown on the multi-information display when the hybrid system is stopped.

- To reduce key battery depletion when the electronic key is to not be used for long periods of time, set the electronic key to the battery-saving mode. (→P.113)
- As the electronic key always receives radio waves, the battery will become depleted even if the electronic key is not used. The following symptoms indicate that the electronic key battery may be depleted. Replace the battery when necessary. (→P.281)
 - The smart entry & start system or the wireless remote control does not operate.
 - The detection area becomes smaller.
 - The LED indicator on the key surface does not turn on.
- To avoid serious deterioration, do not leave the electronic key within 1 m (3 ft.) of the following electrical appliances that produce a magnetic field:
 - TVs
 - Personal computers
 - Cellular phones, cordless phones and battery chargers
 - Recharging cellular phones or cordless phones
 - Table lamps
 - Induction cookers
- If the electronic key is near the vehicle for longer than necessary, even if the smart entry & start system is not operated, the key battery may become depleted faster than normal.

■ Replacing the battery

→P.281

■ The electronic key function is suspended when

The electronic key function may be suspended when the electronic key is kept unmoved in a same location for a certain period, such as it is left on a same place. This is to reduce battery consumption. The function will be restored automatically when the electronic key is moved, such as it is picked up.

■ If “A New Key has been Registered Contact Your Dealer for Details” is shown on the multi-information display

This message will be displayed each time the driver's door is opened when the doors are unlocked from the outside for approximately 10 days after a new electronic key has been registered. If this message is displayed but you have not had a new electronic key registered, ask your Toyota dealer to check if an unknown electronic key (other than those in your possession) has been registered.



NOTICE

■ To prevent key damage

- Do not drop the keys, subject them to strong shocks or bend them.
- Do not expose the keys to high temperatures for long periods of time.
- Do not get the keys wet or wash them in an ultrasonic washer etc.
- Do not attach metallic or magnetic materials to the keys or place the keys close to such materials.
- Do not disassemble the keys.
- Do not attach a sticker or anything else to the surface of the key.
- Do not place the keys near objects that produce magnetic fields, such as TVs, audio systems and induction cookers.
- Do not place the keys near medical electrical equipment such as low-frequency therapy equipment or microwave therapy equipment, and do not receive medical attention with the keys on your person.

■ Carrying the electronic key on your person

Carry the electronic key 10 cm (3.9 in.) or more away from electric appliances that are turned on. Radio waves emitted from electric appliances within 10 cm (3.9 in.) of the electronic key may interfere with the key, causing the key to not function properly.

■ In case of a smart entry & start system malfunction or other key-related problems

→P.328

■ When an electronic key is lost

→P.327

Wireless remote control

The keys are equipped with the following wireless remote control:

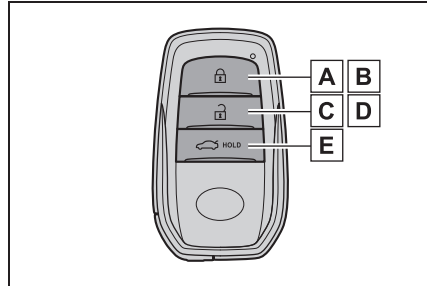

- A** Locks the doors (→P.105)
- B** Closes the windows*¹ and moon roof*^{1, 2}(→P.105)
- C** Unlocks the doors (→P.105)
- D** Opens the windows*¹ and moon roof*^{1, 2} (→P.105)
- E** Opens the trunk (→P.110)

*¹: This setting must be customized at your Toyota dealer.

*2: If equipped

■ **Conditions affecting the operation of the smart entry & start system or wireless remote control**

→P.113

Using the mechanical key

To take out the mechanical key, slide the release button and take the key out.

The mechanical key can only be inserted in one direction, as the key only has grooves on one side. If the key cannot be inserted in a lock cylinder, turn it over and re-attempt to insert it.

After using the mechanical key, store it in the electronic key. Carry the mechanical key together with the electronic key. If the electronic key battery is depleted or the entry function does not operate properly, you will need the mechanical key. (→P.328)

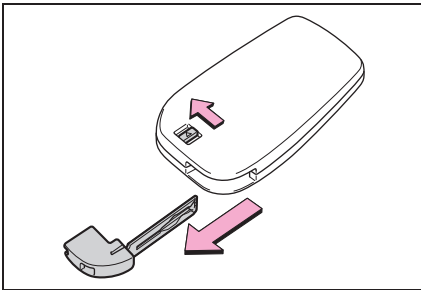

■ **If you lose your mechanical keys**

→P.327

■ **If a wrong key is used**

The key cylinder rotates freely, isolated from the internal mechanism.

Doors

Unlocking and locking the doors from the outside

■ Smart entry & start system

Carry the electronic key to enable this function.

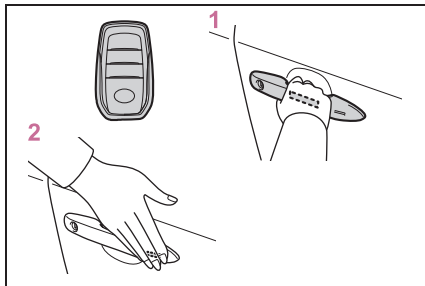

- 1 Grip the front door handle to unlock all the doors.*

Make sure to touch the sensor on the back of the handle.

The doors cannot be unlocked for 3 seconds after the doors are locked.

*: The door unlock settings can be changed. (→P.105, 346)

- 2 Touch the lock sensor (the indentation on the side of the front door handle) to lock all the doors.

Check that the door is securely locked.

■ Wireless remote control

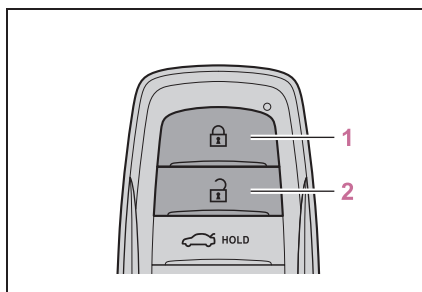

- 1 Locks all the doors

Check that the door is securely locked.

Press and hold to close the windows*¹ and the moon roof*^{1, 2}.

- 2 Unlocks all the doors

Pressing the button unlocks the driver's door. Pressing the button again within 3 seconds unlocks the other doors.*¹



Press and hold to open the windows*¹ and the moon roof*^{1, 2}.

*¹: This setting must be customized at your Toyota dealer.





*²: If equipped

■ Switching the door unlock function

It is possible to set which doors the entry function unlocks using the wireless remote control.

- 1 Turn the power switch off.
- 2 When the indicator light on the key surface is not on, press and hold  or  for approximately 5 seconds while pressing and holding .

The setting changes each time an operation is performed, as shown below. (When changing the setting continuously, release the buttons, wait for at least 5 seconds, and repeat step 2.)

Multi-information display/Beep	Unlocking function
 <p>(4.2-inch or 7-inch display)</p>  <p>(12.3-inch display) Exterior: Beeps 3 times Interior: Pings once</p>	<p>Holding the driver's door handle unlocks only the driver's door.</p> <p>Holding the front passenger's door handle unlocks all the doors.</p>
 <p>(4.2-inch or 7-inch display)</p>  <p>(12.3-inch display) Exterior: Beeps twice Interior: Pings once</p>	<p>Holding either front door handle unlocks all the doors.</p>

■ **Operation signals**

A buzzer sounds and the emergency flashers flash to indicate that the doors have been locked/unlocked using the entry function or wireless remote control. (Locked: Once; Unlocked: Twice)

A buzzer sounds to indicate that the windows and moon roof* are operating.

*: If equipped

■ **Security feature**

If a door is not opened within approximately 30 seconds after the vehicle is unlocked using the entry function or wireless remote control, the security feature automatically locks the vehicle again.

■ **When the door cannot be locked by the lock sensor on the surface of the front door handle**

If the doors cannot be locked by touching the lock sensor with a finger, touch the lock sensor with the palm of your hand.

If you are wearing gloves, remove them.

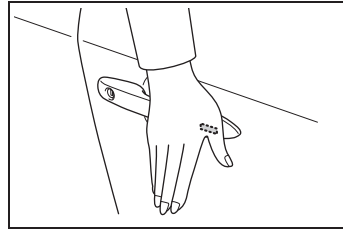

■ **Door lock buzzer**

If an attempt to lock the doors using the entry function (if equipped) or wireless remote control is made when a door is not fully closed, a buzzer will sound continuously for 5 seconds. Fully close the door to stop the buzzer, and lock the doors again.

■ **Conditions affecting the operation of the smart entry & start system or wireless remote control**

→P.113

■ **If the smart entry & start system or the wireless remote control does not operate properly**

Use the mechanical key to lock and unlock the doors. (→P.328)

Replace the key battery with a new one if it is depleted. (→P.281)

■ **If the 12-volt battery is discharged**

The doors cannot be locked and unlocked using the smart entry & start system or wireless remote control. Lock or unlock the doors using the mechani-

cal key. (→P.328)

■ Rear seat reminder function

In order to remind you not to forget luggage, etc. in the rear seat, when the power switch is turned off after any of the following conditions are met, a buzzer will sound and a message will be displayed on the multi-information display for approximately 6 seconds.

- The hybrid system is started within approximately 10 minutes after opening and closing a rear door.
- A rear door has been opened and closed after the hybrid system was started.

However, if a rear door is opened and then closed within approximately 2 seconds, the rear seat reminder function may not operate.

The rear seat reminder function determines that luggage, etc. has been placed in a rear seat based on opening and closing of a rear door. Therefore, depending on the situation, the rear seat reminder function may not operate and you may still forget luggage, etc. in the rear seat, or it may operate unnecessarily.

■ Customization

Some functions can be customized. (→P.346)



WARNING

■ To prevent an accident

Observe the following precautions while driving the vehicle. Failure to do so may result in a door opening and an occupant being thrown out of the vehicle, resulting in death or serious injury.

- Ensure that all doors are properly closed and locked.

- Do not pull the inside door handle while driving. Be especially careful of the driver's door, as the doors may be opened even if the inside lock buttons are in the locked position.

- Set the rear door child-protector locks when children are seated in the rear seats.

■ When opening or closing a door

Check the surroundings of the vehicle such as whether the vehicle is on an incline, whether there is enough space for a door to open and whether a strong wind is blowing. When opening or closing the door, hold the door handle tightly to prepare for any unpredictable movement.

■ When using the wireless remote control or the key and operating the power windows or moon roof (if equipped)

Operate the power windows or moon roof after checking to make sure that there is no possibility of any passenger having any of their body parts caught in the windows or moon roof. Also, do not allow children to operate the wireless remote control or the key. It is possible for children and other passengers to get caught in the power windows or moon roof.

Unlocking and locking the doors from the inside

■ Door lock switches (to lock/unlock)

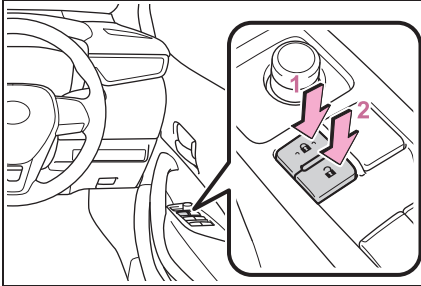

- 1 Locks all the doors
- 2 Unlocks all the doors

■ Inside lock buttons

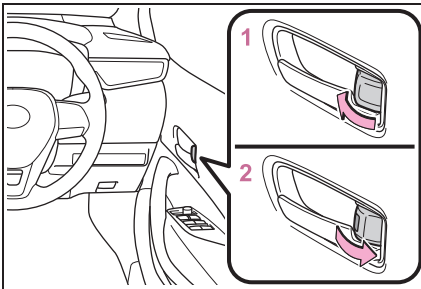

- 1 Locks the door
- 2 Unlocks the door

The driver's door can be opened by pulling the inside handle even if the lock button is in the lock position.

■ Locking the front doors from the outside without a key

- 1 Move the inside lock button to the lock position.
- 2 Close the door while pulling the door handle.

The door cannot be locked if the power switch is in ACC or ON, or the electronic key is left inside the vehicle.

The key may not be detected correctly and the door may be locked.

■ Open door warning buzzer

If a door or the trunk is not fully closed, a buzzer will sound when the vehicle speed reaches 5 km/h (3 mph).

The open door(s) or trunk is indicated on the multi-information display.

Rear door child-protector lock

The door cannot be opened from inside the vehicle when lock is set.

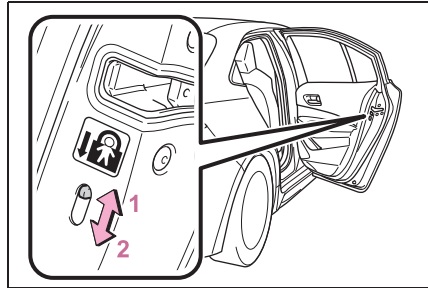

- 1 Unlock
- 2 Lock

These locks can be set to prevent children from opening the rear doors. Push down on each rear door switch to lock both rear doors.

Trunk

The trunk can be opened using the trunk opener, entry function or wireless remote control.

WARNING

Observe the following precautions. Failure to do so may result in death or serious injury.

■ Before driving

- Make sure that the trunk lid is fully closed. If the trunk lid is not fully closed, it may open unexpectedly while driving and hit near-by objects or luggage in the trunk may be thrown out, causing an accident.

- Do not allow children to play in the trunk.

If a child is accidentally locked in the trunk, they could suffer from heat exhaustion, suffocation or other injuries.

- Do not allow a child to open or close the trunk lid. Doing so may cause the trunk lid to open unexpectedly, or cause the child's hands, head, or neck to be caught by the closing trunk lid.

■ Important points while driving

Never let anyone sit in the trunk. In the event of sudden braking or a collision, they are susceptible to death or serious injury.

■ Using the trunk

Observe the following precautions. Failure to do so may cause parts of the body to be caught, resulting in serious injury.

- Remove any heavy loads, such as snow and ice, from the trunk lid before opening it. Failure to do so may cause the trunk lid to suddenly shut again after it is opened.

- When opening or closing the trunk lid, thoroughly check to make sure the surrounding area is safe.
- If anyone is in the vicinity, make sure they are safe and let them know that the trunk is about to open or close.
- Use caution when opening or closing the trunk lid in windy weather as it may move abruptly in strong wind.
- The trunk lid may suddenly shut if it is not opened fully. It is more difficult to open or close the trunk lid on an incline than on a level surface, so beware of the trunk lid unexpectedly opening or closing by itself. Make sure that the trunk lid is fully open and secure before using the trunk.

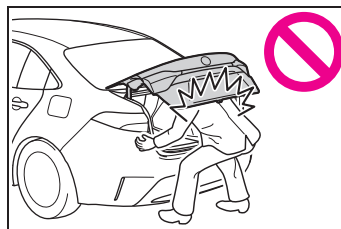

- When closing the trunk lid, take extra care to prevent your fingers etc. from being caught.

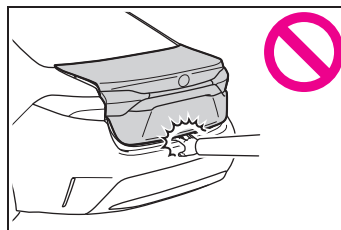

- When closing the trunk lid, make sure to press it lightly on its outer surface.

**WARNING**

- Do not attach any accessories other than genuine Toyota parts to the trunk lid. Such additional weight on the trunk lid may cause the lid to suddenly shut again after it is opened.

Opening the trunk**■ Trunk opener**

Pull the lever upward to release the trunk lid.

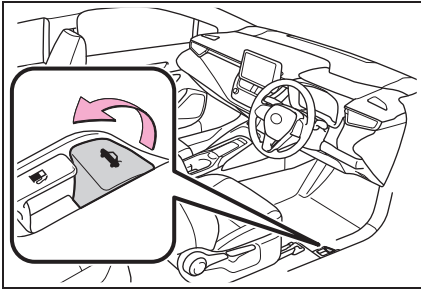
**■ Trunk release button**

While carrying the electronic key, press the button on the trunk lid.

When all the doors are unlocked using one of the following methods, the trunk can be opened without the electronic key:

- Entry function
- Wireless remote control
- Door lock switches
- Mechanical key

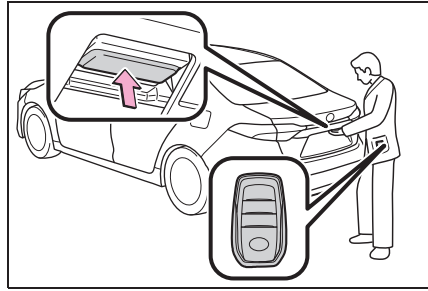
**■ Wireless remote control**

Press and hold the switch.

A buzzer sounds.

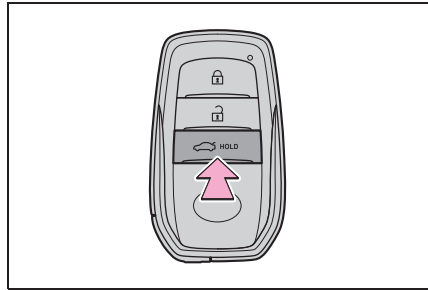
**■ Trunk light**

- The trunk light turns on when the trunk is opened.
- If the trunk light is left on when the power switch is turned off, the light will go off automatically after 20 minutes.

■ Function to prevent the trunk being locked with the electronic key inside

- When all doors are locked, closing the trunk lid with the electronic key left inside the trunk will sound an alarm. In this case, the trunk lid can be opened pressing the trunk release button on the trunk lid.
- If the spare electronic key is put in the trunk with all the doors locked, the key confinement prevention function is activated so the trunk can be opened. In order to prevent theft, take all electronic keys with you when leaving the vehicle.

- If the electronic key is put in the trunk with all the doors locked, the key may not be detected depending on the location of the key and the surrounding radio wave conditions. In this case, the key confinement prevention function cannot be activated, causing the doors to lock when the trunk is closed. Make sure to check where the key is before closing the trunk.
- The key confinement prevention function cannot be activated if any one of the doors is unlocked. In this case, open the trunk using the trunk opener.

■ Internal trunk release lever

The trunk lid can be opened by pulling up the glow-in-the-dark lever located on the inside of the trunk lid.

The lever will continue to glow for some time after the trunk lid is closed.

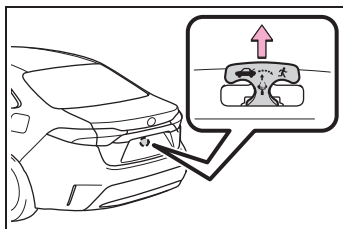

■ If the smart entry & start system or the wireless remote control does not operate properly

Replace the key battery with a new one if it is depleted. (→P.281)

■ Open door warning buzzer

→P.108

■ Customization

Some functions can be customized. (→P.346)

Smart entry & start system

The following operations can be performed simply by carrying the electronic key on your person, for example in your pocket. The driver should always carry the electronic key.

- Locks and unlocks the doors (→P.105)
- Opens the trunk (→P.110)
- Starts the hybrid system (→P.140)

■ Antenna location

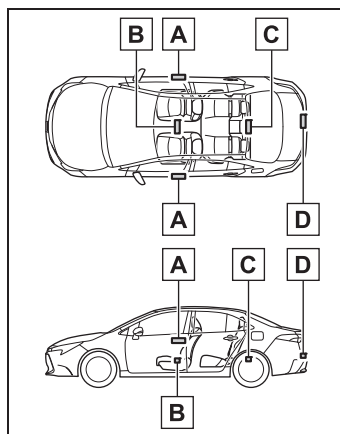

- A** Antennas outside the cabin
- B** Antennas inside the cabin
- C** Antenna inside the trunk
- D** Antenna outside the trunk

■ **Effective range (areas within which the electronic key is detected)**

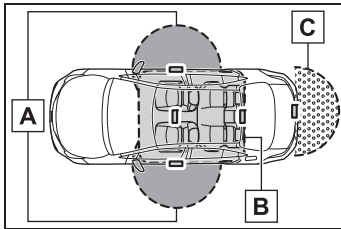

A When locking or unlocking the doors

The system can be operated when the electronic key is within about 0.7 m (2.3 ft.) of either of the front outside door handles. (Only the doors detecting the key can be operated.)

B When starting the hybrid system or changing power switch modes

The system can be operated when the electronic key is inside the vehicle.

C When opening the trunk

The system can be operated when the electronic key is within about 0.7 m (2.3 ft.) of the trunk release button.

■ **Alarms and warning messages**

A combination of exterior and interior buzzers as well as warning messages shown on the multi-information display are used to prevent theft of the vehicle and accidents resulting from erroneous operation. Take appropriate measures based on the displayed message. (→P.305)

When only an alarm sounds, circumstances and correction procedures are as follows.

- Exterior buzzer sounds once for 5 seconds

Situation	Correction procedure
An attempt was made to lock the vehicle while a door was open.	Close all of the doors and lock the doors again.
The trunk was closed while the electronic key was still inside the trunk and all the doors were locked.	Retrieve the electronic key from the trunk and close the trunk lid.

- Interior buzzer sounds continuously

Situation	Correction procedure
The power switch was turned to ACC while the driver's door was open (or the driver's door was opened while the power switch was in ACC).	Turn the power switch off and close the driver's door.
The power switch was turned to off while the driver's door was open.	Close the driver's door

■ **Battery-saving function**



The battery-saving function will be activated in order to prevent the electronic key battery and the 12-volt battery from being discharged while the vehicle is not operated for a long time.

- In the following situations, the smart entry & start system may take some time to unlock the doors.
- The electronic key has been left within approximately 3.5 m (11 ft.) of the outside of the vehicle for 2 minutes or longer.
- The smart entry & start system has not been used for 5 days or longer.
- If the smart entry & start system has not been used for 14 days or longer, the doors cannot be unlocked from

any door except the driver's door. In this case, hold the driver's door handle, or use the wireless remote control or mechanical key to unlock the doors.

■ Electronic key battery-saving function

- When battery-saving mode is set, battery depletion is minimized by stopping the electronic key from receiving radio waves.

Press  twice while pressing and holding . Confirm that the electronic key indicator flashes 4 times.

While the battery-saving mode is set, the smart entry & start system cannot be used. To cancel the function, press any of the electronic key buttons.

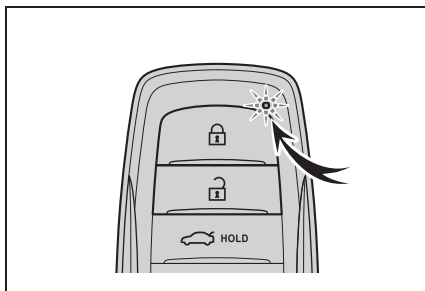

- Electronic keys that will not be used for long periods of time can be set to the battery-saving mode in advance.

■ Conditions affecting operation

The smart entry & start system uses weak radio waves. In the following situations, the communication between the electronic key and the vehicle may be affected, preventing the smart entry & start system, wireless remote control and immobilizer system from operating properly.

- When the electronic key battery is depleted
- Near a TV tower, electric power plant, gas station, radio station, large display, airport or other facility that generates strong radio waves or electrical

noise

- When carrying a portable radio, cellular phone, cordless phone or other wireless communication device
- When the electronic key is in contact with, or is covered by the following metallic objects
 - Cards to which aluminum foil is attached
 - Cigarette boxes that have aluminum foil inside
 - Metallic wallets or bags
 - Coins
 - Hand warmers made of metal
 - Media such as CDs and DVDs
- When other wireless keys (that emit radio waves) are being used nearby
- When carrying the electronic key together with the following devices that emit radio waves
 - Another vehicle's electronic key or a wireless key that emits radio waves
 - Personal computers or personal digital assistants (PDAs)
 - Digital audio players
 - Portable game systems
- If window tint with a metallic content or metallic objects are attached to the rear window

- When the electronic key is placed near a battery charger or electronic devices
- When the vehicle is parked in a pay parking spot where radio waves are emitted

If the doors cannot be locked/unlocked using the smart entry & start system, lock/unlock the doors by performing any of the following:

- Bring the electronic key close to either front door handle and operate the entry function.

- Operate the wireless remote control.

If the doors cannot be locked/unlocked using the above methods, use the mechanical key. (→P.328)

If the hybrid system cannot be started using the smart entry & start system,

refer to P.329.

■ Note for the entry function

- Even when the electronic key is within the effective range (detection areas), the system may not operate properly in the following cases:
 - The electronic key is too close to the window or outside door handle, near the ground, or in a high place when the doors are locked or unlocked.
 - The electronic key is near the ground or in a high place, or too close to the center of the rear bumper when the trunk is opened.
 - The electronic key is on the instrument panel, rear package tray or floor, or in the door pockets or glove box when the hybrid system is started or power switch modes are changed.
- Do not leave the electronic key on top of the instrument panel or near the door pockets when exiting the vehicle. Depending on the radio wave reception conditions, it may be detected by the antenna outside the cabin and the door will become lockable from the outside, possibly trapping the electronic key inside the vehicle.
- As long as the electronic key is within the effective range, the doors may be locked or unlocked by anyone. However, only the doors detecting the electronic key can be used to unlock the vehicle.
- Even if the electronic key is not inside the vehicle, it may be possible to start the hybrid system if the electronic key is near the window.
- The doors may unlock or lock if a large amount of water splashes on the door handle, such as in the rain or in a car wash when the electronic key is within the effective range. (The doors will automatically be locked after approximately 30 seconds if the doors are not opened and closed.)
- If the wireless remote control is used to lock the doors when the electronic key is near the vehicle, there is a possibility that the door may not be unlocked by the entry function. (Use the wireless remote control to unlock the doors.)
- If the doors have been locked from outside of the vehicle and are then not unlocked using the wireless remote control or smart entry & start system, the hybrid system cannot be started using the smart entry & start system. (However, if the doors have been locked from inside the vehicle, the hybrid system can be started using the smart entry & start system.) If it is necessary to start the hybrid system, it can be started using the procedure in "If the electronic key does not operate properly" (→P.329).
- Touching the door lock or unlock sensor while wearing gloves may prevent lock or unlock operation.
- When the lock operation is performed using the lock sensor, recognition signals will be shown up to two consecutive times. After this, no recognition signals will be given.
- If the door handle becomes wet while the electronic key is within the effective range, the door may lock and unlock repeatedly. In that case, follow the following correction procedures to wash the vehicle:
 - Place the electronic key in a location 2 m (6 ft.) or more away from the vehicle. (Take care to ensure that the key is not stolen.)
 - Set the electronic key to battery-saving mode to disable the smart entry & start system. (→P.113)
- If the electronic key is inside the vehicle and a door handle becomes wet during a car wash, a message may be shown on the multi-information display and a buzzer will sound outside the vehicle. To turn off the alarm, lock all the doors.
- The lock sensor may not work properly if it comes into contact with ice, snow, mud, etc. Clean the lock sensor and attempt to operate it again.
- A sudden handle operation or a han-

dle operation immediately after entering the effective range may prevent the doors from being unlocked. Touch the door unlock sensor and check that the doors are unlocked before pulling the door handle again.

- If there is another electronic key in the detection area, it may take slightly longer to unlock the doors after the door handle is gripped.

■ When the vehicle is not driven for extended periods

- To prevent theft of the vehicle, do not leave the electronic key within 2 m (6 ft.) of the vehicle.
- The smart entry & start system can be deactivated in advance. (→P.346)
- Setting the electronic key to battery-saving mode helps to reduce key battery depletion. (→P.113)

■ To operate the system properly

- Make sure to carry the electronic key when operating the system. Do not get the electronic key too close to the vehicle when operating the system from the outside of the vehicle.

Depending on the position and holding condition of the electronic key, the key may not be detected correctly and the system may not operate properly. (The alarm may go off accidentally, or the door lock prevention function may not operate.)

- Do not leave the electronic key inside the trunk.
The key confinement prevention function may not operate, depending on the location of the key (the inside edge of the trunk), conditions (inside a metal bag, close to metallic objects) and the radio waves in the surrounding area. (→P.110)

■ If the smart entry & start system does not operate properly

- Locking and unlocking the doors: →P.328
- Starting the hybrid system: →P.329

■ Customization

Some functions can be customized. (→P.346)

■ If the smart entry & start system has been deactivated in a customized setting

- Locking and unlocking the doors: Use the wireless remote control or mechanical key. (→P.105, 328)
- Starting the hybrid system and changing power switch modes: →P.329
- Stopping the hybrid system: →P.141



WARNING

■ Caution regarding interference with electronic devices

- People with implantable cardiac pacemakers, cardiac resynchronization therapy-pacemakers or implantable cardioverter defibrillators should keep away from the smart entry & start system antennas. (→P.111)

The radio waves may affect the operation of such devices. If necessary, the entry function can be disabled. Ask your Toyota dealer for details, such as the frequency of radio waves and timing of the emitted radio waves. Then, consult your doctor to see if you should disable the entry function.

- Users of any electrical medical device other than implantable cardiac pacemakers, cardiac resynchronization therapy-pacemakers or implantable cardioverter defibrillators should consult the manufacturer of the device for information about its operation under the influence of radio waves. Radio waves could have unexpected effects on the operation of such medical devices.

Ask your Toyota dealer for details on disabling the entry function.

Front seats

Adjustment procedure

► Manual seat

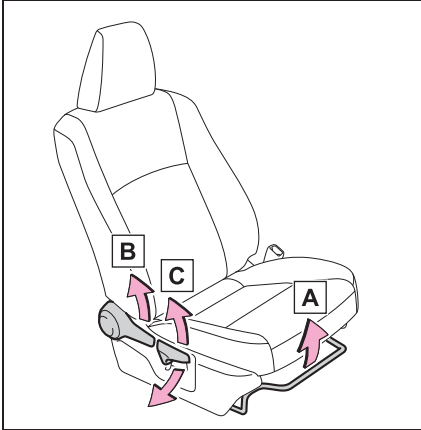

- A** Seat position adjustment lever
- B** Seatback angle adjustment lever
- C** Vertical height adjustment lever (driver's side only)

► Power seat* (driver's side only)

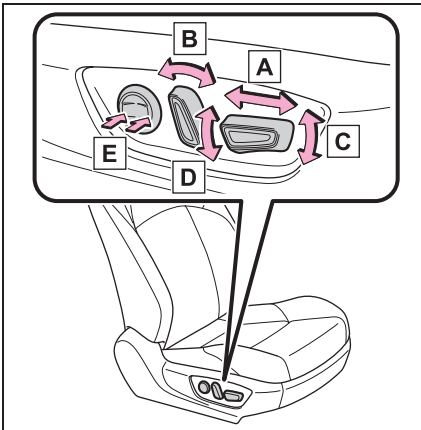

- A** Seat position adjustment switch

- B** Seatback angle adjustment switch
- C** Seat cushion (front) angle adjustment switch
- D** Vertical height adjustment switch
- E** Lumbar support adjustment switch

*: if equipped

⚠ WARNING

■ When adjusting the seat position

- Take care when adjusting the seat position to ensure that other passengers are not injured by the moving seat.

- Do not put your hands under the seat or near the moving parts to avoid injury. Fingers or hands may become jammed in the seat mechanism.

- Make sure to leave enough space around the feet so they do not get stuck.

■ Seat adjustment

- Be careful that the seat does not hit passengers or luggage.

- To reduce the risk of sliding under the lap belt during a collision, do not recline the seat more than necessary.

If the seat is too reclined, the lap belt may slide past the hips and apply restraint forces directly to the abdomen, or your neck may contact the shoulder belt, increasing the risk of death or serious injury in the event of an accident.

Adjustments should not be made while driving as the seat may unexpectedly move and cause the driver to lose control of the vehicle.

**WARNING**

- Manual seat only: After adjusting the seat, make sure that the seat is locked in position.

After adjusting the seat, make sure that the seat is locked in position.

**NOTICE****■ When adjusting a front seat**

When adjusting a front seat, make sure that the head restraint does not contact the headliner. Otherwise, the head restraint and headliner may be damaged.

Rear seats

The seatbacks of the rear seats can be folded down.

Folding down the rear seatbacks

- 1 Move the front seats forward. (→P.116)
- 2 Stow the rear armrest. (→P.251)
- 3 Stow the rear center seat belt buckle.

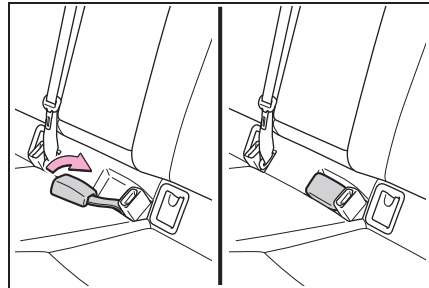

- 4 Seats with an adjustable type head restraint: Lower the head restraints to the lowest position. (→P.119)
- 5 Fold the seatback down while pushing the seatback lock release button.

Each seatback may be folded sepa-

ately.

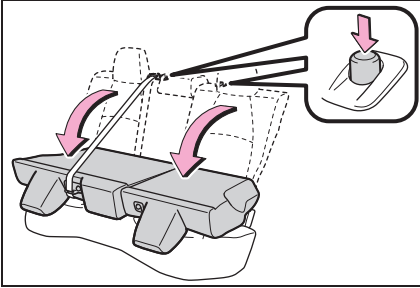

WARNING

Observe the following precautions. Failure to do so may result in death or serious injury.

■ When folding the rear seatbacks down

- Do not fold the seatbacks down while driving.
- Stop the vehicle on level ground, set the parking brake and shift the shift lever to P.
- Do not allow anyone to sit on a folded seatback or in the trunk while driving.
- Do not allow children to enter the trunk.
- Be careful not to get your hand caught when folding the rear seatbacks.
- Adjust the position of the front seats before folding down the rear seatbacks so that the front seats do not interfere with the rear seatbacks when folding down the rear seatbacks.

■ After returning the rear seatback to the upright position

- Make sure that the seatback is securely locked in position by lightly pushing it back and forth.

If the seatback is not securely locked, the red marking will be visible on the seatback lock release button. Make sure that the red marking is not visible.

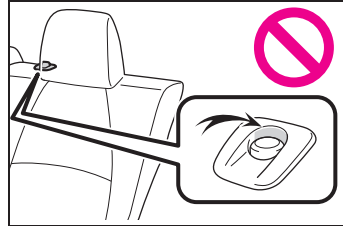

- Check that the seat belts are not twisted or caught in the seatback.

If the seat belt gets caught between the seatback's securing hook and latch, it may damage the seat belt.

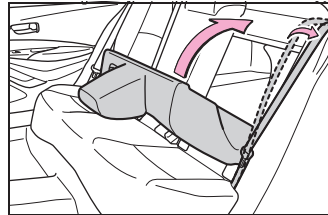

NOTICE

■ When the right seatback is folded down

Make sure the luggage loaded in the enlarged trunk will not damage the webbing of the rear center seat belt.

Head restraints

Head restraints are provided for all seats.

⚠ WARNING

■ Head restraint precautions

Observe the following precautions regarding the head restraints. Failure to do so may result in death or serious injury.

- Use the head restraints designed for each respective seat.
- Adjust the head restraints to the correct position at all times.
- After adjusting the head restraints, push down on them and make sure they are locked in position.
- Do not drive with the head restraints removed.

Adjusting a head restraint

■ Front seats

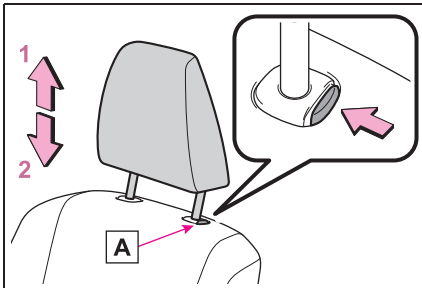

1 Up

Pull the head restraint up.

2 Down

Push the head restraint down while pressing the lock release button **A**.

■ Rear outside seats (adjustable type)

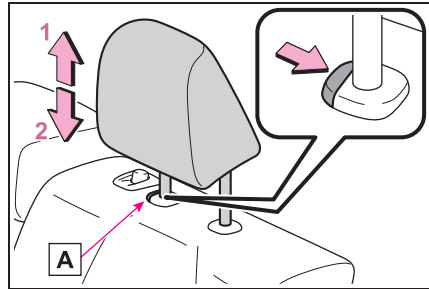

1 Up

Pull the head restraint up.

2 Down

Push the head restraint down while pressing the lock release button **A**.

■ Adjusting the height of the head restraints (front seats)

Make sure that the head restraints are adjusted so that the center of the head restraint is closest to the top of your ears.

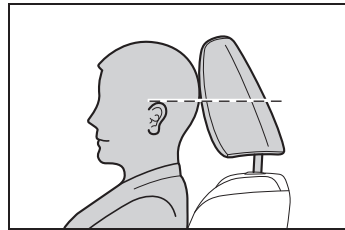

Removing the head restraints

■ Front seats

Pull the head restraint up while pressing the lock release button **A**.

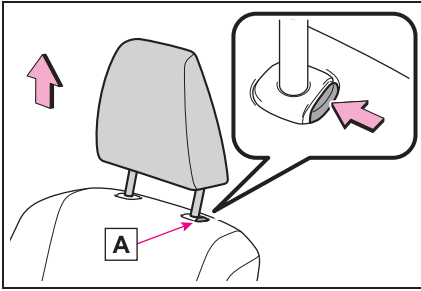

■ Rear outside seats (adjustable type)

Pull the head restraint up while pressing the lock release button **A**.

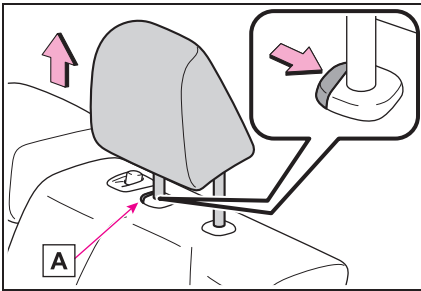

Installing the head restraints

■ Front seats

Align the head restraint with the installation holes and push it down to the lock position.

Press and hold the lock release button **A** when lowering the head restraint.

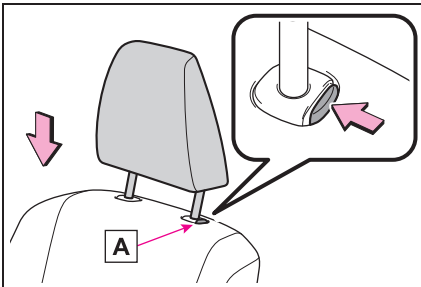

■ Rear outside seats (adjustable type)

Align the head restraint with the installation holes and push it down to the lock position.

Press and hold the lock release button **A** when lowering the head restraint.

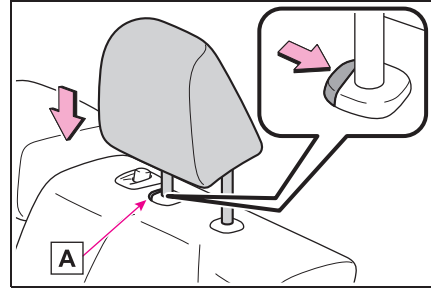

Steering wheel

Adjustment procedure

- 1 Hold the steering wheel and push the lever down.

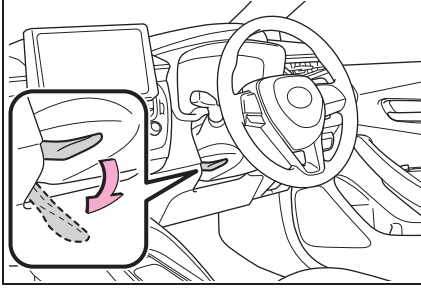

- 2 Adjust to the ideal position by moving the steering wheel horizontally and vertically.

After adjustment, pull the lever up to secure the steering wheel.

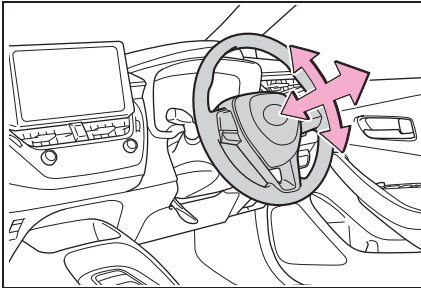

WARNING

■ Caution while driving

Do not adjust the steering wheel while driving. Doing so may cause the driver to mishandle the vehicle and cause an accident, resulting in death or serious injury.

■ After adjusting the steering wheel

Make sure that the steering wheel is securely locked.

Otherwise, the steering wheel may move suddenly, possibly causing an accident, and resulting in death or serious injury. Also, the horn may not sound if the steering wheel is not securely locked.

Horn

To sound the horn, press on or close to the  mark.

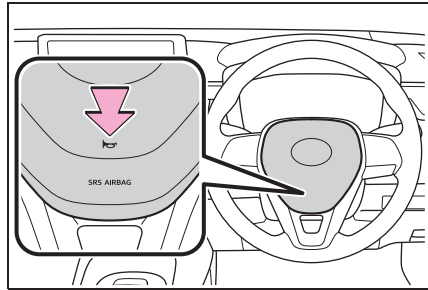

Inside rear view mirror

The rear view mirror's position can be adjusted to enable sufficient confirmation of the rear view.

Adjusting the height of rear view mirror

The height of the rear view mirror can be adjusted to suit your driving posture.

Adjust the height of the rear view mirror by moving it up and down.

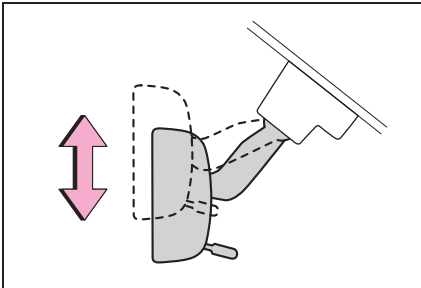

WARNING

■ Caution while driving

Do not adjust the position of the mirror while driving. Doing so may lead to mishandling of the vehicle and cause an accident, resulting in death or serious injury.

Anti-glare function

- ▶ Manual anti-glare inside rear view mirror

Reflected light from the headlights of vehicles behind can be reduced by operating the lever.

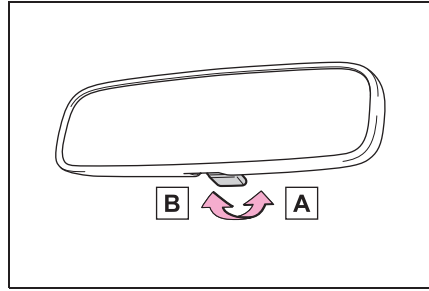

A Normal position

B Anti-glare position

- ▶ Auto anti-glare inside rear view mirror

Responding to the level of brightness of the headlights of vehicles behind, the reflected light is automatically reduced.

Changing automatic anti-glare function mode

On/off

When the automatic anti-glare function is in ON mode, the indicator **A** illuminates. The function will set to ON mode each time the power switch is turned to ON.

Pressing the button turns the function to off mode. (The indicator **A** also turns off.)

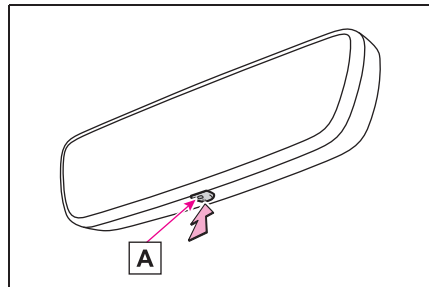

■ **To prevent sensor error (vehicles with an auto anti-glare inside rear view mirror)**

To ensure that the sensors operate properly, do not touch or cover them.

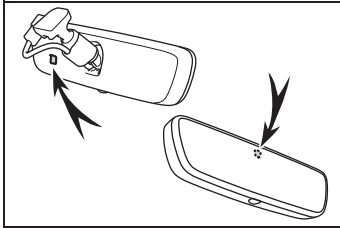

Outside rear view mirrors

The rear view mirror's position can be adjusted to enable sufficient confirmation of the rear view.

■ **When using the outside rear view mirrors in a cold weather**

When it is cold and the outside rear view mirrors are frozen, it may not be possible to fold/extend them or adjust the mirror surface. Remove the ice, snow, etc. covering the outside rear view mirrors.

WARNING

■ **Important points while driving**

Observe the following precautions while driving. Failure to do so may result in loss of control of the vehicle and cause an accident, resulting in death or serious injury.

- Do not adjust the mirrors while driving.
- Do not drive with the mirrors folded.
- Both the driver and passenger side mirrors must be extended and properly adjusted before driving.

Adjustment procedure

- 1 To select a mirror to adjust, turn the switch.

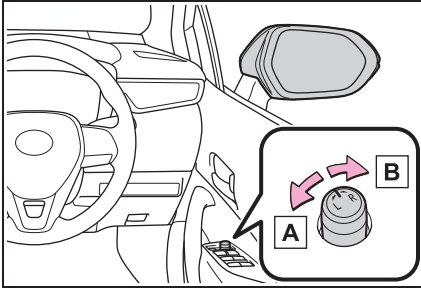

- A** Left
- B** Right

- 2 To adjust the mirror, operate the switch.

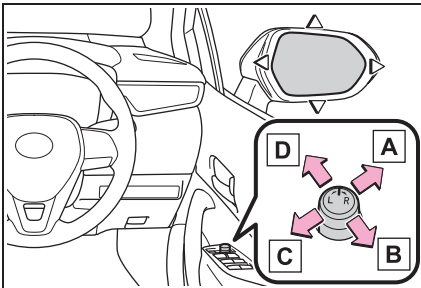

- A** Up
- B** Right
- C** Down
- D** Left

■ Mirror angle can be adjusted when

The power switch is in ACC or ON.

■ When the mirrors are fogged up

The outside rear view mirrors can be cleared using the mirror defoggers. Turn on the rear window defogger to turn on the outside rear view mirror defoggers. (→P.233)

⚠ WARNING

■ When the mirror defoggers are operating

Do not touch the rear view mirror surfaces, as they can become very hot and burn you.

Folding the mirrors

Push the mirror back in the direction of the vehicle's rear.

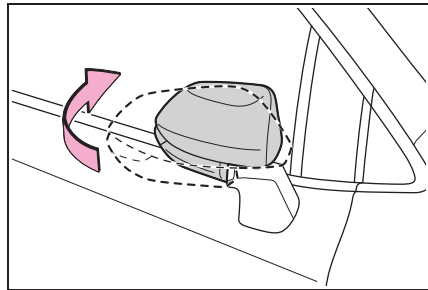

⚠ WARNING

■ When a mirror is moving

To avoid personal injury and mirror malfunction, be careful not to get your hand caught by the moving mirror.

Power windows

Opening and closing the power windows

The power windows can be opened and closed using the switches. Operating the switch moves the windows as follows:

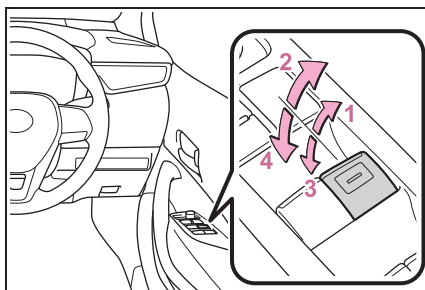

- 1 Closing
- 2 One-touch closing*
- 3 Opening
- 4 One-touch opening*

*: To stop the window partway, operate the switch in the opposite direction.

■ The power windows can be operated when

The power switch is in ON.

■ Operating the power windows after turning the hybrid system off

The power windows can be operated for approximately 45 seconds after the power switch is turned to ACC or OFF. They cannot, however, be operated once either front door is opened.

■ Jam protection function

If an object becomes jammed between the window and the window frame while the window is closing, window movement is stopped and the window is opened slightly.

■ Catch protection function

If an object becomes caught between the door and window while the window is opening, window movement is stopped.

■ When the window cannot be opened or closed

When the jam protection function or catch protection function operates unusually and the door window cannot be opened or closed, perform the following operations with the power window switch of that door.

● Stop the vehicle. With the power switch in ON, within 4 seconds of the jam protection function or catch protection function activating, continuously operate the power window switch in the one-touch closing direction or one-touch opening direction so that the door window can be opened and closed.

● If the door window cannot be opened and closed even when performing the above operations, perform the following procedure for function initialization.

- 1 Turn the power switch to ON.
- 2 Pull and hold the power window switch in the one-touch closing direction and completely close the door window.
- 3 Release the power window switch for a moment, resume pulling the switch in the one-touch closing direction, and hold it there for approximately 6 seconds or more.
- 4 Press and hold the power window switch in the one-touch opening direction. After the door window is completely opened, continue holding the switch for an additional 1 second or more.
- 5 Release the power window switch for a moment, resume pushing the switch in the one-touch opening direction, and hold it there for approximately 4 seconds or more.
- 6 Pull and hold the power window switch in the one-touch closing

direction again. After the door window is completely closed, continue holding the switch for a further 1 second or more.

If you release the switch while the window is moving, start again from the beginning.

If the window reverses and cannot be fully closed or opened, have the vehicle inspected by your Toyota dealer.

■ Door lock linked window operation

- The power windows can be opened and closed using the mechanical key.* (→P.328)
- The power windows can be opened and closed using the wireless remote control.* (→P.105)

*: These settings must be customized at your Toyota dealer.

■ Customization

Some functions can be customized. (→P.346)



WARNING

Observe the following precautions. Failure to do so may result in death or serious injury.

■ Closing the windows

- The driver is responsible for all the power window operations, including the operation for the passengers. In order to prevent accidental operation, especially by a child, do not let a child operate the power windows. It is possible for children and other passengers to have body parts caught in the power window. Also, when riding with a child, it is recommended to use the window lock switch. (→P.127)

- Check to make sure that all passengers do not have any part of their body in a position where it could be caught when a window is being operated.

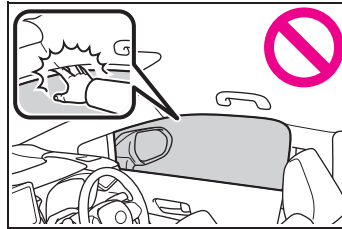

- When using the wireless remote control or mechanical key and operating the power windows, operate the power window after checking to make sure that there is no possibility of any passenger having any of their body parts caught in the window. Also do not let a child operate window by the wireless remote control or mechanical key. It is possible for children and other passengers to get caught in the power window.
- When exiting the vehicle, turn the power switch off, carry the key and exit the vehicle along with the child. There may be accidental operation, due to mischief, etc., that may possibly lead to an accident.
- Jam protection function
 - Never use any part of your body to intentionally activate the jam protection function.
 - The jam protection function may not work if something gets jammed just before the window is fully closed. Be careful not to get any part of your body jammed in the window.
- Catch protection function
 - Never use any part of your body or clothing to intentionally activate the catch protection function.

**WARNING**

- The catch protection function may not work if something gets caught just before the window is fully opened. Be careful not to get any part of your body or clothing caught in the window.

Preventing accidental operation (window lock switch)

This function can be used to prevent children from accidentally opening or closing a passenger window.

Press the switch.

The indicator **A** will come on and the passenger windows will be locked.

The passenger windows can still be opened and closed using the driver's switch even if the lock switch is on.

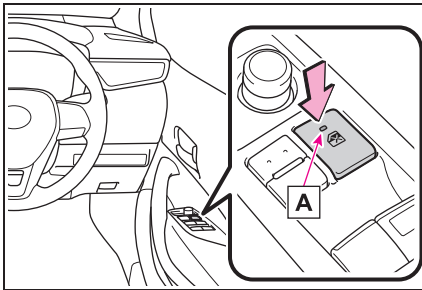

■ The power windows can be operated when

The power switch is in ON.

■ When the 12-volt battery is disconnected

The window lock switch is disabled. If necessary, press the window lock switch after reconnecting the 12-volt battery.

Moon roof*

*: If equipped

Use the overhead switches to open and close the moon roof and tilt it up and down.

Operating the moon roof

■ Opening and closing

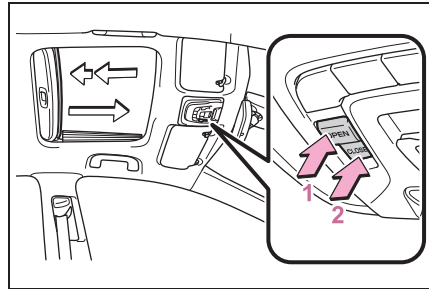

1 Opens the moon roof*

The moon roof stops slightly before the fully open position to reduce wind noise. Press the switch again to fully open the moon roof.

2 Closes the moon roof*

*: Lightly press either side of the moon roof switch to stop the moon roof partway.

■ Tilting up and down

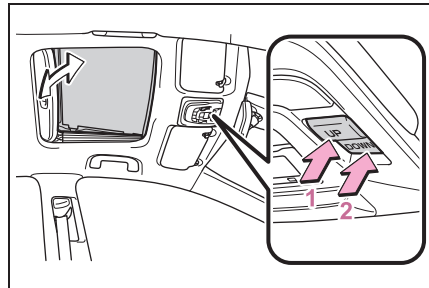

1 Tilts the moon roof up*

2 Tilts the moon roof down*

*: Lightly press either side of the moon roof switch to stop the moon roof partway.

■ The moon roof can be operated when

The power switch is in ON.

■ Operating the moon roof after turning the hybrid system off

The moon roof can be operated for approximately 45 seconds after the power switch is turned to ACC or OFF. It cannot, however, be operated once either front door is opened.

■ Jam protection function

If an object is detected between the moon roof and the frame while the moon roof is closing or tilting down, travel is stopped and the moon roof opens slightly.

■ Sunshade

The sunshade can be opened and closed manually. However, the sunshade will open automatically when the moon roof is opened.

■ Door lock linked moon roof operation

- The moon roof can be opened and closed using the mechanical key.* (→P.328)
- The moon roof can be opened and closing using the wireless remote control.* (→P.105)

*: These settings must be customized at your Toyota dealer.

■ When the moon roof does not close normally

Perform the following procedure:

- If the moon roof closes but then re-opens slightly
 - 1** Stop the vehicle.
 - 2** Press and hold the “CLOSE” switch.*¹

The moon roof will close, reopen and pause for approximately 10 seconds.*² Then it will close again, tilt up and pause for approximately 1 second. Finally, it will tilt down, open and close.

- 3** Check to make sure that the moon roof is completely closed and then release the switch.

● If the moon roof tilts down but then tilts back up

- 1** Stop the vehicle.
- 2** Press and hold the “UP” switch*¹ until the moon roof moves into the tilt up position and stops.
- 3** Release the “UP” switch once and then press and hold the “UP” switch again.*¹

The moon roof will pause for approximately 10 seconds in the tilt up position.*² Then it will adjust slightly and pause for approximately 1 second. Finally, it will tilt down, open and close.

- 4** Check to make sure that the moon roof is completely closed and then release the switch.

*¹: If the switch is released at the incorrect time, the procedure will have to be performed again from the beginning.

*²: If the switch is released after the above mentioned 10 second pause, automatic operation will be disabled. In that case, press and hold the “CLOSE” or “UP” switch, and the moon roof will tilt up and pause for approximately 1 second. Then it will tilt down, open and close. Check to make sure that the moon roof is completely closed and then release the switch.

If the moon roof does not fully close even after performing the above procedure correctly, have the vehicle inspected by your Toyota dealer.

■ Customization

Some functions can be customized.
(→P.346)



WARNING

Observe the following precautions.
Failure to do so may cause death or serious injury.

■ Opening the moon roof

- Do not allow any passengers to put their hands or heads outside the vehicle while it is moving.
- Do not sit on top of the moon roof.

■ Opening and closing the moon roof

- The driver is responsible for moon roof opening and closing operations.
In order to prevent accidental operation, especially by a child, do not let a child operate the moon roof. It is possible for children and other passengers to have body parts caught in the moon roof.
- Check to make sure that all passengers do not have any part of their body in a position where it could be caught when the moon roof is being operated.

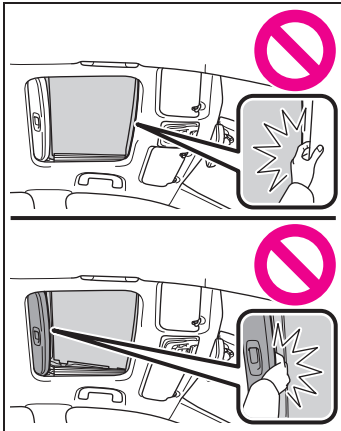

- When using the wireless remote control or mechanical key and operating the moon roof, operate the moon roof after checking to make sure that there is no possibility of any passenger having any of their body parts caught in the moon roof. Also, do not let a child operate moon roof by the wireless remote control or mechanical key. It is possible for children and other passengers to get caught in the moon roof.

- When exiting the vehicle, turn the power switch off, carry the key and exit the vehicle along with the child. There may be accidental operation, due to mischief, etc., that may possibly lead to an accident.

■ Jam protection function

- Never use any part of your body to intentionally activate the jam protection function.
- The jam protection function may not work if something gets caught just before the moon roof is fully closed. Also, the jam protection function is not designed to operate while the moon roof switch is being pressed. Take care so that your fingers, etc. do not get caught.

My Settings

Drivers are identified using devices such as electronic keys to store the vehicle settings for each. Then the information can be recalled the next time the vehicle is driven.

Authentication devices can be assigned in advance to drivers so that they can drive using their preferred settings.

Settings for 3 drivers can be stored in My Settings.

For information on authentication devices registration/deletion, changing the driver's name, initializing driver registered settings, manually switching drivers and deleting drivers registration refer to the "Multimedia Owner's Manual".

Types of assigned authentication devices

An individual can be identified using the following authentication devices.

- Electronic key

An individual is identified when the smart entry & start system detects their electronic key. (→P.111)

- Bluetooth® device

An individual is identified when a Bluetooth® device is connected to the audio system. For information on how

to connect Bluetooth® devices, refer to the "Multimedia Owner's Manual".

When an individual is identified with an electronic key identifying using a Bluetooth® device is not performed.

Recalled functions

When an individual is identified from an authentication device, settings for the following functions are recalled.

- Meter displays and audio system information *

When an individual is identified, the display settings used when the power switch was last turned off are recalled.

- Vehicle settings that can be set using the audio system *

When an individual is identified, the vehicle settings used when the power switch was last turned off are recalled.

*: Some settings are excluded

- 4-1. Before driving**
 - Driving the vehicle **132**
 - Cargo and luggage **138**
 - Trailer towing **139**
- 4-2. Driving procedures**
 - Power (ignition) switch..... **140**
 - EV drive mode **144**
 - Hybrid transmission **146**
 - Turn signal lever **148**
 - Parking brake **149**
 - Brake Hold **152**
- 4-3. Operating the lights and wipers**
 - Headlight switch **154**
 - AHB (Automatic High Beam)
 - **156**
 - Fog light switch..... **159**
 - Windshield wipers and washer
 - **160**
- 4-4. Refueling**
 - Opening the fuel tank cap
 - **163**
- 4-5. Using the driving support systems**
 - Toyota Safety Sense..... **165**
 - PCS (Pre-Collision System)
 - **171**
 - LTA (Lane Tracing Assist)
 - **181**
 - LDA (Lane Departure Alert)
 - **186**
 - Emergency Driving Stop System **191**
 - RSA (Road Sign Assist) **193**
 - Dynamic radar cruise control
 - **195**
 - Cruise control..... **204**
 - BSM (Blind Spot Monitor)
 - **206**
 - RCTA (Rear Cross Traffic Alert)
 - function **211**
 - Safe Exit Assist **216**
 - Driving mode select switch
 - **220**
 - Driving assist systems **221**
- 4-6. Driving tips**
 - Hybrid vehicle driving tips
 - **226**
 - Winter driving tips **228**

Driving the vehicle

The following procedures should be observed to ensure safe driving:

Driving procedure

■ Starting the hybrid system

→P.140

■ Driving

- 1 With the brake pedal depressed, shift the shift lever to D.
(→P.146)
- 2 Release the parking brake.
(→P.149)

If the parking brake is in automatic mode, the parking brake will be released automatically. (→P.150)

- 3 Gradually release the brake pedal and gently depress the accelerator pedal to accelerate the vehicle.

■ Stopping

- 1 With the shift lever in D, depress the brake pedal.
- 2 If necessary, set the parking brake. (→P.149)

If the vehicle is to be stopped for an extended period of time, shift the shift lever to P. (→P.146)

■ Parking the vehicle

- 1 With the shift lever in D, depress the brake pedal to stop the vehicle completely.

- 2 Set the parking brake (→P.149), and shift the shift lever to P.
(→P.146)

Make sure the parking brake indicator light is on.

- 3 Press the power switch to stop the hybrid system.
- 4 Slowly release the brake pedal.
- 5 Lock the door, making sure that you have the electronic key on your person.

If parking on a hill, block the wheels as needed.

■ Starting off on a steep uphill

- 1 Make sure that the parking brake is set and shift the shift lever to D.
- 2 Gently depress the accelerator pedal.
- 3 Release the parking brake.

■ For fuel-efficient driving

Keep in mind that hybrid vehicles are similar to conventional vehicles, and it is necessary to refrain from activities such as sudden acceleration. (→P.226)

■ Driving in the rain

- Drive carefully when it is raining, because visibility will be reduced, the windows may become fogged-up, and the road will be slippery.
- Drive carefully when it starts to rain, because the road surface will be especially slippery.
- Refrain from high speeds when driving on an expressway in the rain, because there may be a layer of water between the tires and the road surface, preventing the steering and brakes from operating properly.

■ Restraining the hybrid system output (Brake Override System)

- When the accelerator and brake pedals are depressed at the same time, the hybrid system output may be restrained.
- A warning message is displayed on the multi-information display while the system is operating.

■ ECO Accelerator Guidance (→P.82, 90)

Eco-friendly driving may be achieved more easily by staying within the zone of Eco acceleration. Also, by staying within the zone of Eco acceleration, it will be easier to obtain a good Eco score.

- When starting off:

Gradually depress the accelerator pedal to stay within the zone of Eco acceleration and accelerate to the desired speed. By refraining from excessive acceleration, a good eco start score will be obtained.

- When driving:

After accelerating to the desired speed, release the accelerator pedal and drive at a stable speed while staying within the zone of Eco acceleration. By staying within the zone of Eco acceleration, a good eco cruise score will be obtained.

- When stopping:

By starting to release the accelerator pedal early before decelerating, a good eco stop score will be obtained.

■ Breaking in your new Toyota

To extend the life of the vehicle, observing the following precautions is recommended:

- For the first 300 km (186 miles):

Avoid sudden stops.

- For the first 1000 km (621 miles):

- Do not drive at extremely high speeds.
- Avoid sudden acceleration.
- Do not drive at a constant speed for extended periods.

■ Operating your vehicle in a foreign country

Comply with the relevant vehicle registration laws and confirm the availability of the correct fuel. (→P.339)

WARNING

Observe the following precautions.

Failure to do so may result in death or serious injury.

■ When starting the vehicle

Always keep your foot on the brake pedal while stopped with the “READY” indicator is illuminated. This prevents the vehicle from creeping.

■ When driving the vehicle

- Do not drive if you are unfamiliar with the location of the brake and accelerator pedals to avoid depressing the wrong pedal.
- Accidentally depressing the accelerator pedal instead of the brake pedal will result in sudden acceleration that may lead to an accident.
- When backing up, you may twist your body around, leading to a difficulty in operating the pedals. Make sure to operate the pedals properly.
- Make sure to keep a correct driving posture even when moving the vehicle only slightly. This allows you to depress the brake and accelerator pedals properly.
- Depress the brake pedal using your right foot. Depressing the brake pedal using your left foot may delay response in an emergency, resulting in an accident.
- The driver should pay extra attention to pedestrians when the vehicle is powered only by the electric motor (traction motor). As there is no engine noise, the pedestrians may misjudge the vehicle’s movement.

**WARNING**

- Do not drive the vehicle over or stop the vehicle near flammable materials.
The exhaust system and exhaust gases can be extremely hot. These hot parts may cause a fire if there is any flammable material nearby.
 - During normal driving, do not turn off the hybrid system. Turning the hybrid system off while driving will not cause loss of steering or braking control, however, power assist to the steering will be lost. This will make it more difficult to steer smoothly, so you should pull over and stop the vehicle as soon as it is safe to do so.
In the event of an emergency, such as if it becomes impossible to stop the vehicle in the normal way:
→P.290
 - Use engine braking (shift position B) to maintain a safe speed when driving down a steep hill. Using the brakes continuously may cause the brakes to overheat and lose effectiveness. (→P.146)
 - Do not adjust the positions of the steering wheel, the seat, or the inside or outside rear view mirrors while driving.
Doing so may result in a loss of vehicle control.
 - Always check that all passengers' arms, heads or other parts of their body are not outside the vehicle.
- **When driving on slippery road surfaces**
- Sudden braking, acceleration and steering may cause tire slippage and reduce your ability to control the vehicle.

- Sudden acceleration, engine braking due to shifting, or changes in engine speed could cause the vehicle to skid.
 - After driving through a puddle, lightly depress the brake pedal to make sure that the brakes are functioning properly. Wet brake pads may prevent the brakes from functioning properly. If the brakes on only one side are wet and not functioning properly, steering control may be affected.
- **When shifting the shift lever**
- Do not let the vehicle roll backward while the shift lever is in a driving position, or roll forward while the shift lever is in R. Doing so may result in an accident or damage to the vehicle.
 - Do not shift the shift lever to P while the vehicle is moving. Doing so can damage the transmission and may result in a loss of vehicle control.
 - Do not shift the shift lever to R while the vehicle is moving forward. Doing so can damage the transmission and may result in a loss of vehicle control.
 - Do not shift the shift lever to a driving position while the vehicle is moving backward. Doing so can damage the transmission and may result in a loss of vehicle control.
 - Moving the shift lever to N while the vehicle is moving will disengage the hybrid system. Engine braking is not available with the hybrid system disengaged.
 - Be careful not to shift the shift lever with the accelerator pedal depressed. Shifting the shift lever to any positions other than P or N may lead to unexpected rapid acceleration of the vehicle that may cause an accident and result in death or serious injury.

**WARNING****■ If you hear a squealing or scraping noise (brake pad wear indicators)**

Have the brake pads checked and replaced by your Toyota dealer as soon as possible.

Rotor damage may result if the pads are not replaced when needed.

It is dangerous to drive the vehicle when the wear limits of the brake pads and/or those of the brake discs are exceeded.

■ When the vehicle is stopped

- Do not depress the accelerator pedal unnecessarily. If the shift lever is any position other than P or N, the vehicle may accelerate suddenly and unexpectedly, causing an accident.
- In order to prevent accidents due to the vehicle rolling away, always keep depressing the brake pedal while stopped with the “READY” indicator is illuminated, and apply the parking brake as necessary.
- If the vehicle is stopped on an incline, in order to prevent accidents caused by the vehicle rolling forward or backward, always depress the brake pedal and securely apply the parking brake as needed.
- Avoid revving or racing the engine. Running the engine at high speed while the vehicle is stopped may cause the exhaust system to overheat, which could result in a fire if combustible material is nearby.

■ When the vehicle is parked

- Do not leave glasses, cigarette lighters, spray cans, or soft drink cans in the vehicle when it is in the sun. Doing so may result in the following:
 - Gas may leak from a cigarette lighter or spray can, and may lead to a fire.
 - The temperature inside the vehicle may cause the plastic lenses and plastic material of glasses to deform or crack.
 - Soft drink cans may fracture, causing the contents to spray over the interior of the vehicle, and may also cause a short circuit in the vehicle’s electrical components.
- Do not leave cigarette lighters in the vehicle. If a cigarette lighter is in a place such as the glove box or on the floor, it may be lit accidentally when luggage is loaded or the seat is adjusted, causing a fire.
- Do not attach adhesive discs to the windshield or windows. Do not place containers such as air fresheners on the instrument panel or dashboard. Adhesive discs or containers may act as lenses, causing a fire in the vehicle.
- Do not leave a door or window open if the curved glass is coated with a metallized film such as a silver-colored one. Reflected sunlight may cause the glass to act as a lens, causing a fire.

**WARNING**

- Always apply the parking brake, shift the shift lever to P, stop the hybrid system and lock the vehicle. Do not leave the vehicle unattended while the “READY” indicator is illuminated.
If the vehicle is parked with the shift lever in P but the parking brake is not set, the vehicle may start to move, possibly leading to an accident.
- Do not touch the exhaust pipes while the “READY” indicator is illuminated or immediately after turning the hybrid system off. Doing so may cause burns.

■ When taking a nap in the vehicle

Always turn the hybrid system off. Otherwise, if you accidentally move the shift lever or depress the accelerator pedal, this could cause an accident or fire due to hybrid system overheating. Additionally, if the vehicle is parked in a poorly ventilated area, exhaust gases may collect and enter the vehicle, leading to death or a serious health hazard.

■ When braking

- When the brakes are wet, drive more cautiously.
Braking distance increases when the brakes are wet, and this may cause one side of the vehicle to brake differently than the other side. Also, the parking brake may not securely hold the vehicle.
- If the electronically controlled brake system does not operate, do not follow other vehicles closely and avoid hills or sharp turns that require braking.
In this case, braking is still possible, but the brake pedal should be depressed more firmly than usual. Also, the braking distance will increase. Have your brakes fixed immediately.

- The brake system consists of 2 or more individual hydraulic systems; if one of the systems fails, the other(s) will still operate. In this case, the brake pedal should be depressed more firmly than usual and the braking distance will increase. Have your brakes fixed immediately.

■ If the vehicle becomes stuck

Do not spin the wheels excessively when a driven wheel is up in the air, or the vehicle is stuck in sand, mud, etc. This may damage the driveline components or propel the vehicle forward or backward, causing an accident.

**NOTICE****■ When driving the vehicle**

- Do not depress the accelerator and brake pedals at the same time during driving, as this may restrain the hybrid system output.
- Do not use the accelerator pedal or depress the accelerator and brake pedals at the same time to hold the vehicle on a hill.

■ When parking the vehicle

Always set the parking brake and shift the shift lever to P. Failure to do so may cause the vehicle to move or the vehicle may accelerate suddenly if the accelerator pedal is accidentally depressed.

■ Avoiding damage to vehicle parts

- Do not turn the steering wheel fully in either direction and hold it there for an extended period of time. Doing so may damage the power steering.
- When driving over bumps in the road, drive as slowly as possible to avoid damaging the wheels, underside of the vehicle, etc.

**NOTICE****■ If you get a flat tire while driving**

A flat or damaged tire may cause the following situations. Hold the steering wheel firmly and gradually depress the brake pedal to slow down the vehicle.

- It may be difficult to control your vehicle.
- The vehicle will make abnormal sounds or vibrations.
- The vehicle will lean abnormally.

Information on what to do in case of a flat tire (→P.319)

■ When encountering flooded roads

Do not drive on a road that has flooded after heavy rain etc. Doing so may cause the following serious damage to the vehicle:

- Engine stalling
- Short in electrical components
- Engine damage caused by water immersion

In the event that you drive on a flooded road and the vehicle becomes flooded or stuck in mud or sand, be sure to have your Toyota dealer check the following:

- Brake function
- Changes in quantity and quality of oil and fluid used for the engine, hybrid transmission, etc.
- Lubricant condition for the bearings and suspension joints (where possible), and the function of all joints, bearings, etc.

Sudden start restraint control (Drive-Start Control [DSC])

When the following unusual operation is performed with the accelerator pedal depressed, the hybrid system output may be restrained.

- When the shift lever is shifted to R*.
- When the shift lever is shifted from P or R to forward drive shift position such as D*.

When the system operates, a message appears on the multi-information display. Read the message and follow the instruction.

*: Depending on the situation, the shift position may not be changed.

■ Drive-Start Control (DSC)

When the TRC is turned off (→P.222), sudden start restraint control also does not operate. If your vehicle have trouble escaping from the mud or fresh snow due to sudden start restraint control operation, deactivate TRC (→P.222) so that the vehicle may become able to escape from the mud or fresh snow.

Cargo and luggage

Take notice of the following information about storage precautions, cargo capacity and load:



WARNING

■ Things that must not be carried in the trunk

The following things may cause a fire if loaded in the trunk:

- Receptacles containing gasoline
- Aerosol cans

■ Storage precautions

Observe the following precautions.

Failure to do so may prevent the pedals from being depressed properly, may block the driver's vision, or may result in items hitting the driver or passengers, possibly causing an accident.

- Stow cargo and luggage in the trunk whenever possible.
- To prevent cargo and luggage from sliding forward during braking, do not stack anything in the enlarged trunk. Keep cargo and luggage low, as close to the floor as possible.
- When you fold down the rear seats, long items should not be placed directly behind the front seats.
- Do not place cargo or luggage in or on the following locations.
 - At the feet of the driver
 - On the front passenger or rear seats (when stacking items)
 - On the package tray
 - On the instrument panel
 - On the dashboard

- Secure all items in the occupant compartment.
- Never allow anyone to ride in the enlarged trunk. It is not designed for passengers. They should ride in their seats with their seat belts properly fastened.

■ Load and distribution

- Do not overload your vehicle.
- Do not apply loads unevenly.

Improper loading may cause deterioration of steering or braking control which may cause death or serious injury.

Trailer towing

Toyota does not recommend towing a trailer with your vehicle. Toyota also does not recommend the installation of a tow hitch or the use of a tow hitch carrier for a wheelchair, scooter, bicycle, etc. Your vehicle is not designed for trailer towing or for the use of tow hitch mounted carriers.

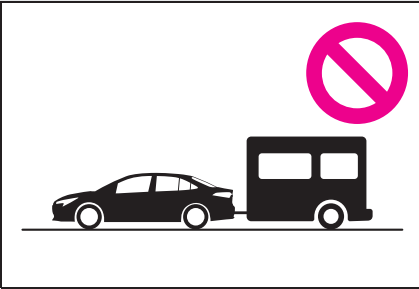

Power (ignition) switch

Performing the following operations when carrying the electronic key on your person starts the hybrid system or changes power switch modes.

Starting the hybrid system

- 1 Check that the parking brake is set. (→P.149)
- 2 Check that the shift lever is in P.
- 3 Firmly depress the brake pedal.

 and a message will be displayed on the multi-information display. If it is not displayed, the hybrid system cannot be started.

- 4 Press the power switch shortly and firmly.

When operating the power switch, one short, firm press is enough. It is not necessary to press and hold the switch.

If the “READY” indicator turns on, the hybrid system will operate normally.

Continue depressing the brake pedal until the “READY” indicator is illuminated.

The hybrid system can be started from any power switch mode.

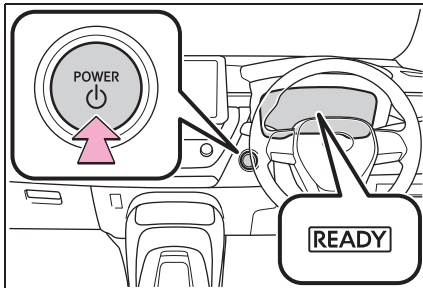

- 5 Check that the “READY” indicator is illuminated.

The vehicle cannot be driven if the “READY” indicator is off.

Power switch illumination

According to the situation, the power switch illumination operates as follows:

- When a door is opened, or the power switch mode is changed from ACC or ON to off, the power switch illumination comes on.
- When depressing the brake pedal with carrying the electronic key on your person, the power switch illumination blinks.
- When the power switch mode is in ACC or ON, the power switch illumination is constantly illuminated.

If the hybrid system does not start

- The immobilizer system may not have been deactivated. (→P.66) Contact your Toyota dealer.
- If a message related to start-up is shown on the multi-information display, read the message and follow the instructions.

When the ambient temperature is low, such as during winter driving conditions

- When starting the hybrid system, the flashing time of the “READY” indicator may be long. Leave the vehicle as it is until the “READY” indicator is steady on, as steady means the vehicle is able to move.
- When the hybrid battery (traction battery) is extremely cold (below approximately -30°C [-22°F]) under the influence of the outside temperature, it may not be possible to start the hybrid system. In this case, try to start the hybrid system again after the temperature of the hybrid battery increases due to the outside temperature increase etc.

■ Sounds and vibrations specific to a hybrid vehicle

→P.60

■ If the 12-volt battery is discharged

The hybrid system cannot be started using the smart entry & start system. Refer to P.330 to restart the hybrid system.

■ Electronic key battery depletion

→P.102

■ Conditions affecting operation

→P.113

■ Notes for the entry function

→P.114

■ If the “READY” indicator does not come on

In the event that the “READY” indicator does not come on even after performing the proper procedures for starting the vehicle, contact your Toyota dealer immediately.

■ If the hybrid system is malfunctioning

→P.64

■ Electronic key battery

→P.281

■ Operation of the power switch

- If the switch is not pressed shortly and firmly, the power switch mode may not change or the hybrid system may not start.
- If attempting to restart the hybrid system immediately after turning the power switch off, the hybrid system may not start in some cases. After turning the power switch off, please wait a few seconds before restarting the hybrid system.

■ Customization

If the smart entry & start system has been deactivated in a customized setting, refer to P.328.



WARNING

■ When starting the hybrid system

Always start the hybrid system while sitting in the driver’s seat. Do not depress the accelerator pedal while starting the hybrid system under any circumstances.

Doing so may cause an accident resulting in death or serious injury.



NOTICE

■ When starting the hybrid system

If the hybrid system becomes difficult to start, have your vehicle checked by your Toyota dealer immediately.

■ Symptoms indicating a malfunction with the power switch

If the power switch seems to be operating somewhat differently than usual, such as the switch sticking slightly, there may be a malfunction. Contact your Toyota dealer immediately.

Stopping the hybrid system

- 1 Stop the vehicle completely.
- 2 Set the parking brake (→P.149), and shift the shift lever to P.

Check the parking brake indicator is illuminated.

- 3 Press the power switch shortly and firmly.

The hybrid system will stop, and the meter display will be extinguished.

- 4 Release the brake pedal and check that “ACCESSORY” or “IGNITION ON” is not shown on the multi-information display.



WARNING

■ Stopping the hybrid system in an emergency

- If you want to stop the hybrid system in an emergency while driving the vehicle, press and hold the power switch for more than 2 seconds, or press it briefly 3 times or more in succession. (→P.290) However, do not touch the power switch while driving except in an emergency. Turning the hybrid system off while driving will not cause loss of steering or braking control, however, power assist to the steering will be lost. This will make it more difficult to steer smoothly, so you should pull over and stop the vehicle as soon as it is safe to do so.
- If the power switch is operated while the vehicle is running, a warning message will be shown on the multi-information display and a buzzer sounds.
- To restart the hybrid system after performing an emergency shut-down, shift the shift lever to N and then press the power switch.

Changing power switch modes

Modes can be changed by pressing the power switch with brake pedal released. (The mode changes each time the switch is pressed.)

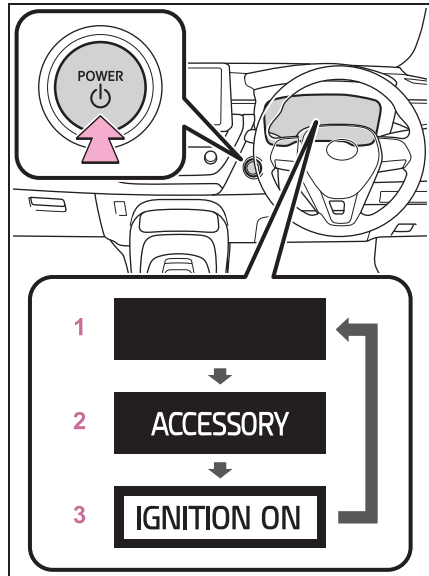

1 OFF^{*1}

The emergency flashers can be used.

2 ACC^{*2}

Some electrical components such as the audio system can be used.

“ACCESSORY” will be displayed on the multi-information display.

3 ON

All electrical components can be used.

“IGNITION ON” will be displayed on the multi-information display.

^{*1}: If the shift lever is in a position other than P when turning off the hybrid system, the power switch will be turned to ACC, not to off.

^{*2}: ACC mode can be enabled/disabled on the customize menu. (→P.346)

■ Auto power off function

If the vehicle is left in ACC or ON (the hybrid system is not operating) for more than 20 minutes with the shift lever in P, the power switch will automatically turn off.

Also, if the remaining 12-volt battery is low with the shift lever in P and the power switch in ACC or ON (hybrid system is not operating), a buzzer sounds and a message is displayed in the multi-information display. If left in this state, the power switch automatically turns to off.

However, this function cannot entirely prevent 12-volt battery discharge. Do not leave the vehicle with the power switch in ACC or ON for long periods of time when the hybrid system is not operating.

■ When ACC customization is in off

With the power switch is turned off, the multimedia system can still be used for a certain time until the battery saving function starts operating.

	NOTICE
<p>■ To prevent 12-volt battery discharge</p> <ul style="list-style-type: none"> ● Do not leave the power switch in ACC or ON for long periods of time without the hybrid system on. ● If “ACCESSORY” or “IGNITION ON” is displayed on the multi-information display, the power switch is not off. Exit the vehicle after turning the power switch off. 	

When stopping the hybrid system with the shift lever in a position other than P

If the hybrid system is stopped with the shift lever in a position other than P, the power switch will not be turned off. Perform the following procedure to turn the switch off:

- 1 Check that the parking brake is set.
- 2 Shift the shift lever to P.

- 3 Check that “IGNITION ON” is displayed on the multi-information display and press the power switch shortly and firmly.
- 4 Check that “ACCESSORY” or “IGNITION ON” on the multi-information display are off.

	NOTICE
<p>■ To prevent 12-volt battery discharge</p> <p>Do not stop the hybrid system when the shift lever is in a position other than P. If the hybrid system is stopped in another shift lever position, the power switch will not be turned off and remained to ON. If the vehicle is left in ON, battery discharge may occur.</p>	

EV drive mode

In EV drive mode, electric power is supplied by the hybrid battery (traction battery), and only the electric motor (traction motor) is used to drive the vehicle.

This mode allows you to drive in residential areas early in the morning and late at night, or in indoor parking lots etc. without concern for noises and gas emissions.

Operating instructions

Turns EV drive mode on/off

When EV drive mode is turned on, the EV drive mode indicator will come on. Pressing the switch when in EV drive mode will return the vehicle to normal driving (using the gasoline engine and electric motor [traction motor]).

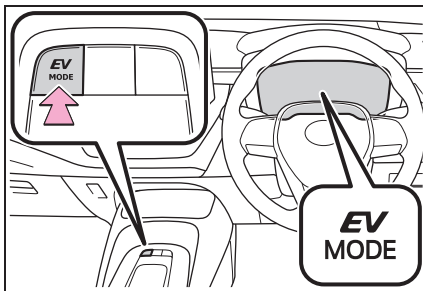

Situations in which EV drive mode cannot be turned on

It may not be possible to turn EV drive mode on in the following situations. If it cannot be turned on, a buzzer will sound and a message will be shown on the multi-information display.

- The temperature of the hybrid system is high.
The vehicle has been left in the sun, driven on a hill, driven at high speeds, etc.
- The temperature of the hybrid system is low.
The vehicle has been left for a long period of time etc.
- The gasoline engine is warming up.
- The hybrid battery (traction battery) is low.
The remaining battery level indicated in the energy monitor display is low. (→P.97)
- Vehicle speed is high.
- The accelerator pedal is depressed firmly or the vehicle is on a hill etc.
- The windshield defogger is in use.

Switching to EV drive mode when the gasoline engine is cold

After the hybrid system has started and the “READY” indicator has illuminated, press the EV drive mode switch before the gasoline engine starts to switch to EV drive mode.

However, depending on vehicle conditions, EV drive mode may be canceled and normal driving (using the gasoline engine and electric motor [traction motor]) may be resumed.

Automatic cancelation of EV drive mode

When driving in EV drive mode, the gasoline engine may start automatically and the vehicle may be driven by the gasoline engine and electric motor (traction motor) in the following situations. When EV drive mode is canceled, a buzzer will sound, the EV drive mode indicator will flash, and a message will be displayed on the multi-information display.

- The hybrid battery (traction battery) becomes low.
The remaining battery level indicated in the energy monitor display is low. (→P.97)
- Vehicle speed is high.

- The accelerator pedal is depressed firmly or the vehicle is on a hill etc.

■ Possible driving distance when driving in EV drive mode

EV drive mode's possible driving distance ranges from a few hundred meters to approximately 1 km (0.6 mile). However, depending on vehicle conditions, there are situations when EV drive mode cannot be used.

(The distance that is possible depends on the hybrid battery [traction battery] level and driving conditions.)

■ Fuel economy

The hybrid system is designed to achieve the best possible fuel economy during normal driving (using the gasoline engine and electric motor [traction motor]). Driving in EV drive mode more than necessary may lower fuel economy.

■ If “EV Mode Unavailable” is shown on the multi-information display

The EV drive mode is not available. The reason the EV drive mode is not available (the vehicle is idling, battery charge is low, vehicle speed is higher than the EV drive mode operating speed range or accelerator pedal is depressed too much) may be displayed. Use the EV drive mode when it becomes available.

■ If “EV Mode Deactivated” is shown on the multi-information display

The EV drive mode has been automatically canceled. The reason the EV drive mode is not available (the battery charge is low, vehicle speed is higher than the EV drive mode operating speed range or accelerator pedal is depressed too much) may be displayed. Drive the vehicle for a while before attempting to turn on the EV drive mode again.



WARNING

■ Caution while driving

When driving in EV drive mode, pay special attention to the area around the vehicle. Because there is no engine noise, pedestrians, people riding bicycles or other people and vehicles in the area may not be aware of the vehicle starting off or approaching them, so take extra care while driving.

Hybrid transmission

Select the shift position depending on your purpose and situation.

Shift position purpose and functions

Shift position	Objective or function
P	Parking the vehicle/starting the hybrid system
R	Reversing
N	Neutral (Condition in which the power is not transmitted)
D	Normal driving*
B	Applying moderate engine braking driving down hills

*: To improve fuel efficiency and reduce noise, shift the shift lever to D for normal driving.

■ Restraining sudden start (Drive-Start Control)

→P.132



WARNING

■ When driving on slippery road surfaces

Do not accelerate or shift gears suddenly.

Sudden changes in engine braking may cause the vehicle to spin or skid, resulting in an accident.



NOTICE

■ Hybrid battery (traction battery) charge

If the shift lever is in N, the hybrid battery (traction battery) will not be charged even when the engine is running. Therefore, if the vehicle is left with the shift lever in N for a long period of time, the hybrid battery (traction battery) will discharge, and this may result in the vehicle not being able to start.

Shifting the shift lever

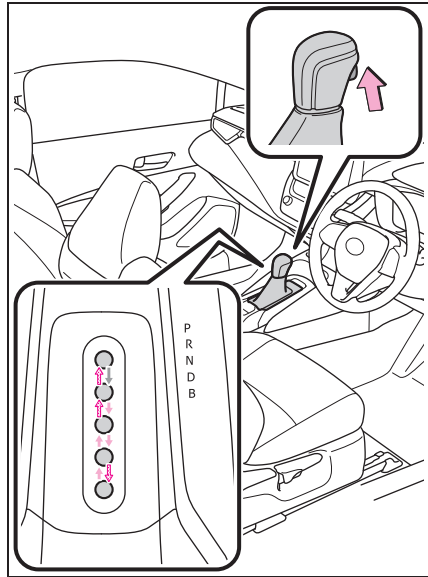

←: While the power switch is in ON and the brake pedal is depressed*, shift the shift lever while pushing the shift release button on the shift knob.

←: Shift the shift lever while pushing the shift release button on the shift knob.

←: Shift the shift lever normally.

When shifting the shift lever between P and D, make sure that the vehicle is completely stopped.

*: For the vehicle be able to be shifted from P, the brake pedal must be depressed before the shift release button is pushed. If the shift release button is pushed first, the shift lock will not be released.

■ **Shift lock system**

The shift lock system is a system to prevent accidental operation of the shift lever in starting.

The shift lever can be shifted from P only when the power switch is in ON, the brake pedal is depressed and the shift release button is pushed.

■ **If the shift lever cannot be shifted from P**

First, check whether the brake pedal is being depressed.

If the shift lever cannot be shifted with your foot on the brake pedal, there may be a problem with the shift lock system. Have the vehicle inspected by your Toyota dealer immediately.

The following steps may be used as an emergency measure to ensure that the shift lever can be shifted.

Releasing the shift lock:

- 1 Set the parking brake.
- 2 Turn the power switch off.
- 3 Depress the brake pedal.
- 4 Pry the cover up with a flathead screwdriver or equivalent tool. To prevent damaging the cover,

wrap the tip of the flathead screwdriver with a tape.

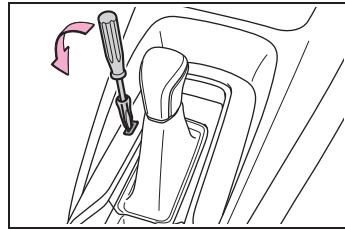

- 5 Press and hold the shift lock override button and then push the shift release button on the shift knob.

The shift lever can be shifted while both buttons are pressed.

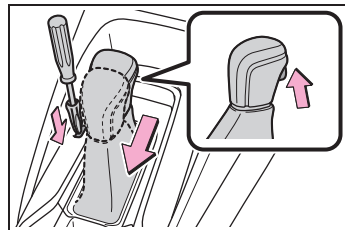

■ **About engine braking**

When shift position B is selected, releasing the accelerator pedal will apply engine braking.

- When the vehicle is driven at high speeds, compared to ordinary gasoline-fueled vehicles, the engine braking deceleration is felt less than that of other vehicles.
- The vehicle can be accelerated even when shift position B is selected.

If the vehicle is driven continuously in the B position, fuel efficiency will become low. Usually, select the D position.

**WARNING**

■ **To prevent an accident when releasing the shift lock**

Before pressing the shift lock override button, make sure to set the parking brake and depress the brake pedal. If the accelerator pedal is accidentally depressed instead of the brake pedal when the shift lock override button is pressed and the shift lever is shifted out of P, the vehicle may suddenly start, possibly leading to an accident resulting in death or serious injury.

Selecting the driving mode

→P.220

Turn signal lever

Operating instructions

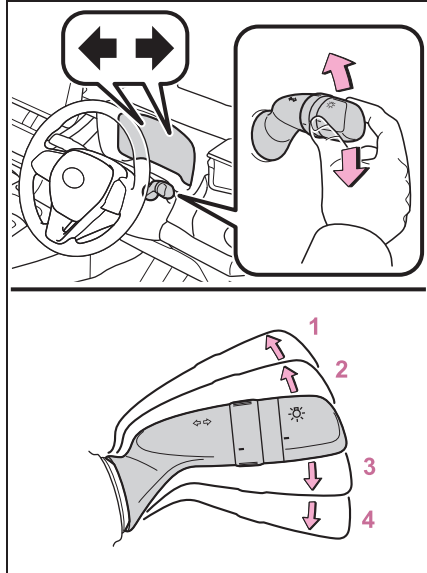

- 1** Left turn
- 2** Lane change to the left (move the lever partway and release it)
The left hand signals will flash 3 times.
- 3** Lane change to the right (move the lever partway and release it)
The right hand signals will flash 3 times.
- 4** Right turn

■ **Turn signals can be operated when**

The power switch is in ON.

■ **If the indicator flashes faster than usual**

Check that a light bulb in the front or rear turn signal lights has not burned out.

Parking brake

The parking brake can be set or released automatically or manually.

In automatic mode, the parking brake can be set or released automatically according to shift lever operation.

Also, even in automatic mode, the parking brake can be set or released manually.

Operating instructions

■ Using the manual mode

The parking brake can be set and released manually.

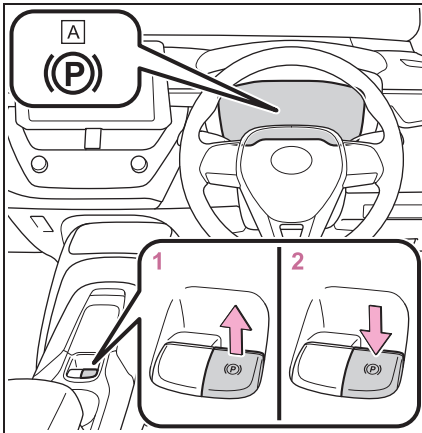

A Parking brake indicator light

1 Pull the switch to set the parking brake.

The parking brake indicator light will turn on.

Pull and hold the parking brake switch if an emergency occurs and it is neces-

sary to operate the parking brake while driving.

2 Press the switch to release the parking brake.

- Operate the parking brake switch while depressing the brake pedal.
- Using the parking brake automatic release function, the parking brake can be released by depressing the accelerator pedal. When using this function, slowly depress the accelerator pedal. (→P.150)

Make sure that the parking brake indicator light turn off.

If the parking brake indicator light flash, operate the switch again. (→P.303)

■ Turning the automatic mode on

While the vehicle is stopped, pull and hold the parking brake switch until a buzzer sounds and a message is shown on the multi-information display.

When the automatic mode is turned on, the parking brake operates as follows.

- When the shift lever is shifted from P, the parking brake will be released, and the parking brake indicator light will turn off.
- When the shift lever is shifted to P, the parking brake will be set, and the parking brake indicator light will turn on.

Operate the shift lever with the vehicle stopped and the brake pedal depressed.

The auto function may not operate if the

shift lever is moved extremely quickly. In this situation, apply the parking brake manually. (→P.149)

■ Turning the automatic mode off

While the vehicle is stopped and depressing the brake pedal, press and hold the parking brake switch until a buzzer sounds and a message is shown on the multi-information display.

■ Parking brake operation

- When the power switch is not in ON, the parking brake cannot be released using the parking brake switch.
- When the power switch is not in ON, automatic mode (automatic brake setting and releasing) is not available.

■ Parking brake automatic release function

When all of the following conditions are met, the parking brake can be released by depressing the accelerator pedal.

- The driver's door is closed
- The driver is wearing the seat belt
- The shift lever is in a forward driving position or reverse driving position
- The malfunction indicator lamp or brake system warning light is not illuminated.

When depressing the accelerator pedal, depress it slowly.

If the parking brake is not released when the accelerator pedal is depressed, release the parking brake manually.

When the shift lever is shifted from P, the parking brake will be released automatically.

■ Parking brake automatic lock function

The parking brake will be set automatically under the following conditions:

- The brake pedal is not depressed
- The driver's door is open
- The driver's seat belt is not fastened
- The shift lever is in a position other than P or N
- The malfunction indicator lamp and brake system warning light are not illuminated

■ If "Parking Brake Temporarily Unavailable" is displayed on the multi-information display

If the parking brake is operated repeatedly over a short period of time, the system may restrict operation to prevent overheating. If this happens, refrain from operating the parking brake. Normal operation will return after about 1 minute.

■ If "Parking Brake Unavailable" is displayed on the multi-information display

Operate the parking brake switch. If the message does not disappear after operating the switch several times, the system may be malfunctioning. Have the vehicle inspected by your Toyota dealer.

■ Parking brake operation sound

When the parking brake operates, a motor sound (whirring sound) may be heard. This does not indicate a malfunction.

■ Parking brake indicator light

- Depending on the power switch mode, the parking brake indicator light will turn on and stay on as described below:

ON: Comes on until the parking brake is released.

Not in ON: Stays on for approximately 15 seconds.

- When the power switch is turned off with the parking brake set, the parking brake indicator light will stay on for about 15 seconds. This does not indicate a malfunction.

■ When the parking brake switch malfunctions

Automatic mode (automatic brake setting and releasing) will be turned on automatically.

■ Parking the vehicle

→P.132

■ Parking brake engaged warning buzzer

A buzzer will sound if the vehicle is driven with the parking brake engaged. "Parking Brake ON" is displayed on the multi-information display (with the vehicle reaching a speed of 5 km/h [3 mph]).

■ If the brake system warning light comes on

→P.298

■ Usage in winter time

→P.228



WARNING

■ When parking the vehicle

Do not leave a child in the vehicle alone. The parking brake may be released unintentionally by a child and there is the danger of the vehicle moving that may lead to an accident resulting in death or serious injury.

■ Parking brake switch

Do not set any objects near the parking brake switch. Objects may interfere with the switch and may lead the parking brake to unexpectedly operate.

■ Parking brake automatic lock function

Never use the automatic parking brake engagement function in place of normal parking brake operation. This function is designed to reduce the risk of a collision due to the driver forgetting to engage the parking brake. Over-reliance on this function to park the vehicle safely may lead to an accident resulting in death or serious injury.



NOTICE

■ When parking the vehicle

Before you leave the vehicle, shift the shift lever to P, set the parking brake and make sure that the vehicle does not move.

■ When the system malfunctions

Stop the vehicle in a safe place and check the warning messages.

■ When the vehicle battery is discharged

The parking brake system cannot be activated. (→P.330)

■ When the parking brake cannot be released due to a malfunction

Driving the vehicle with the parking brake set will lead to brake components overheating, which may affect braking performance and increase brake wear.

Have the vehicle inspected by your Toyota dealer immediately if this occurs.

Brake Hold

The brake hold system keeps the brake applied when the shift lever is in D, B or N with the system on and the brake pedal has been depressed to stop the vehicle. The system releases the brake when the accelerator pedal is depressed with the shift lever in D or B to allow smooth start off.

Enabling the system

Turn the brake hold system on

The brake hold standby indicator (green) **A** comes on. While the system is holding the brake, the brake hold operated indicator (yellow) **B** comes on.

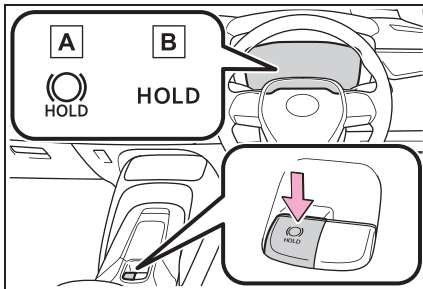

Brake hold system operating conditions

The brake hold system cannot be turned on in the following conditions:

- The driver's door is not closed.
- The driver is not wearing the seat belt.
- The parking brake is engaged.

If any of the conditions above are detected when the brake hold system is

enabled, the system will turn off and the brake hold standby indicator light will go off. In addition, if any of the conditions are detected while the system is holding the brake, a warning buzzer will sound and a message will be shown on the multi-information display. The parking brake will then be set automatically.

Brake hold function

- If the brake pedal is left released for a period of about 3 minutes after the system has started holding the brake, the parking brake will be set automatically. In this case, a warning buzzer sounds and a message is shown on the multi-information display.
- To turn the system off while the system is holding the brake, firmly depress the brake pedal and press the button again.
- The brake hold function may not hold the vehicle when the vehicle is on a steep incline. In this situation, it may be necessary for the driver to apply the brakes. A warning buzzer will sound and the multi-information display will inform the driver of this situation. If a warning message is shown on the multi-information display, read the message and follow the instructions.
- When do not wish for the parking brake to operate automatically, press and hold the brake hold switch until the standby indicator (green) turns off, and then turn the power switch off.

When the parking brake is set automatically while the system is holding the brakes

Perform any of the following operations to release the parking brake:

- Depress the accelerator pedal. (The parking brake will not be released automatically if the seat belt is not fastened.)
- Operate the parking brake switch with the brake pedal depressed.

Make sure that the parking brake indicator light goes off. (→P.149)

■ When an inspection at your Toyota dealer is necessary

When the brake hold standby indicator (green) does not illuminate even when the brake hold switch is pressed with the brake hold system operating conditions met, the system may be malfunctioning. Have the vehicle inspected at your Toyota dealer.

■ If “Brake Hold Malfunction Press Brake to Deactivate Visit Your Dealer” or “Brake Hold Malfunction Visit Your Dealer” is displayed on the multi-information display

The system may be malfunctioning. Have the vehicle inspected by your Toyota dealer.

■ Warning messages and buzzers

Warning messages and buzzers are used to indicate a system malfunction or to inform the driver of the need for caution. If a warning message is shown on the multi-information display, read the message and follow the instructions.

■ If the brake hold operated indicator flashes

→P.304



NOTICE

■ When parking the vehicle

The brake hold system is not designed for use when parking the vehicle for a long period of time. Turning the power switch off while the system is holding the brake may release the brake, which would cause the vehicle to move. When operating the power switch, depress the brake pedal, shift the shift lever to P and set the parking brake.



WARNING

■ When the vehicle is on a steep incline

Take care when using the brake hold system on a steep incline, exercise caution. The brake hold function may not hold brakes in such situations.

Also, the system may not activate depending on the angle of the slope.

■ When stopped on a slippery road

The system cannot stop the vehicle when the gripping ability of the tires has been exceeded. Do not use the system when stopped on a slippery road.



Headlight switch

The headlights can be operated manually or automatically.

Operating instructions

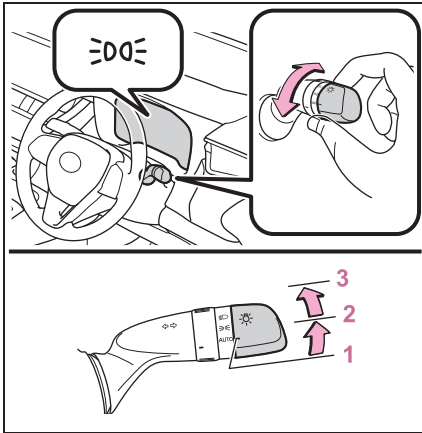
Operating the  switch turns on the lights as follows:



- 1  The headlights, daytime running lights (→P.154) and all the lights listed below turn on and off automatically.
- 2  The front position, tail, license plate, instrument panel lights turn on.
- 3  The headlights and all lights listed above turn on.

■ AUTO mode can be used when

The power switch is in ON.

■ Daytime running light system

To make your vehicle more visible to other drivers during daytime driving, the daytime running lights turn on automati-

cally whenever the hybrid system is started and the parking brake is released with the headlight switch in the AUTO position. (Illuminate brighter than the front position lights.) Daytime running lights are not designed for use at night.

■ Headlight control sensor

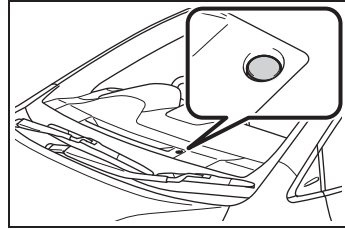

The sensor may not function properly if an object is placed on the sensor, or anything that blocks the sensor is affixed to the windshield.

Doing so interferes with the sensor detecting the level of ambient light and may cause the automatic headlight system to malfunction.

■ Automatic light off system

- When the headlights are on: The headlights and tail lights turn off 30 seconds after the driver's door is opened and closed if the power switch is turned to ACC or OFF. (The lights turn off immediately if  on the key is pressed after all the doors are closed.)
- When only the tail lights are on: The tail lights turn off automatically if the power switch is turned to ACC or OFF and the driver's door is opened.

To turn the lights on again, turn the power switch to ON.

■ Light reminder buzzer

A buzzer sounds when the power switch is turned to OFF or ACC and the driver's door is opened while the lights are turned on.

■ **12-volt battery-saving function**

In order to prevent the 12-volt battery of the vehicle from discharging, if the headlights and/or tail lights are on when the power switch is turned off the 12-volt battery saving function will operate and automatically turn off all the lights after approximately 20 minutes. When the power switch is turned to ON, the 12-volt battery-saving function will be disabled.

When any of the following are performed, the 12-volt battery-saving function is canceled once and then reactivated. All the lights will turn off automatically 20 minutes after the 12-volt battery-saving function has been reactivated:

- When the headlight switch is operated
- When a door or the trunk is opened or closed

■ **Customization**

Some functions can be customized. (→P.346)

NOTICE

■ **To prevent 12-volt battery discharge**

Do not leave the lights on longer than necessary when the hybrid system is off.

Turning on the high beam headlights

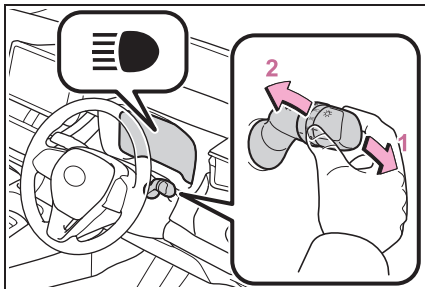

- 1 With the headlights on, push the lever away from you to turn on

the high beams.

Pull the lever toward you to the center position to turn the high beams off.

- 2 Pull the lever toward you and release it to flash the high beams once.

You can flash the high beams with the headlights on or off.

Manual headlight leveling dial

The level of the headlights can be adjusted according to the number of passengers and the loading condition of the vehicle.

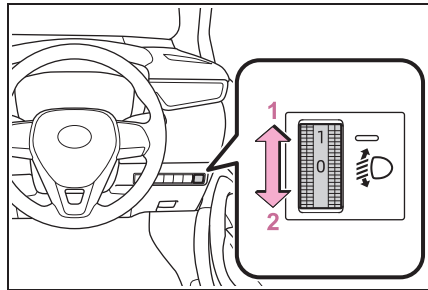

- 1 Raises the level of the headlights
- 2 Lowers the level of the headlights

■ **Guide to dial settings**

Occupancy and luggage load conditions		Dial position
Occupants	Luggage load	
Driver	None	0
Driver and front passenger	None	0.5

Occupancy and luggage load conditions		Dial position
Occupants	Luggage load	
All seats occupied	None	2
All seats occupied	Full luggage loading	2.5
Driver	Full luggage loading	4

AHB (Automatic High Beam)

The Automatic High Beam uses a front camera located on the upper portion of the windshield to detect the brightness of the lights of vehicles ahead, streetlights, etc., and automatically changes the head lights between the high beams and low beams.

WARNING

■ For safe use

Do not overly rely on the Automatic High Beam. Always drive safely, taking care to observe your surroundings and turning the high beams on or off manually if necessary.

■ To prevent unintentional operation of the Automatic High Beam System

- When it is necessary to disable the system: →P.165

Using the Automatic High Beam system

- 1 Press the Automatic High Beam switch.

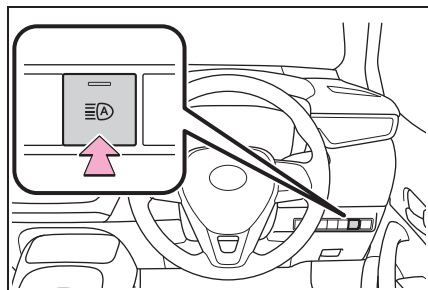

- 2 Turn the headlight switch to the AUTO or  position.

When the headlight switch lever is in the low beam position, the AHB system will be enabled and the AHB indicator will illuminate.

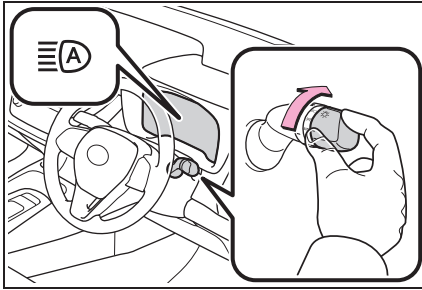

■ Automatic operating conditions of the high beams

- When all of the following conditions are met, the high beams will illuminate automatically:
 - The vehicle speed is approximately 30 km/h (19 mph) or more.
 - The area ahead of the vehicle is dark.
 - There are no vehicles ahead with lights on.
 - There are few streetlights or other lights on the road ahead.
- If any of the following conditions are met, the headlights will change to the low beams:
 - Vehicle speed drops below approximately 25 km/h (16 mph).
 - The area ahead of the vehicle is not dark.
 - There is a vehicle ahead with lights on.
 - There are many streetlights or other lights on the road ahead.

■ Front camera detection

- In the following situations, the high beams may not be automatically changed to the low beams:
 - When a vehicle cuts in front of your vehicle
 - When another vehicle crosses in front

- of the vehicle
- When vehicles ahead are repeatedly detected and then hidden due to repeated curves, road dividers or roadside trees
- When a vehicle ahead approaches from a far lane
- When a vehicle ahead is far away
- When a vehicle ahead has no lights
- When the lights of a vehicle ahead are dim
- When a vehicle ahead is reflecting strong light, such as own headlights
- Situations in which the sensors may not operate properly: →P.168

- The headlights may change to the low beams if a vehicle ahead that is using fog lights without its headlights turned on is detected.

- House lights, street lights, traffic signals, and illuminated billboards or signs may cause the high beams to change to the low beams, or the low beams to remain on.

- The following may change the timing at which the headlights change to the low beams:

- The brightness of lights of vehicles ahead
- The movement and direction of vehicles ahead
- The distance between the vehicle and a vehicle ahead
- When a vehicle ahead only has lights illuminated on one side
- When a vehicle ahead is a two-wheeled vehicle
- The condition of the road (gradient, curve, condition of the road surface, etc.)
- The number of passengers and amount of luggage

- The headlights may change between the high beams and low beams unexpectedly.

- Bicycles and other small vehicles may not be detected.

- In the following situations, the system may not be able to correctly detect the brightness of the surroundings. This

may cause the low beams to remain on or the high beams to flash or dazzle pedestrians or vehicles ahead. In such a case, it is necessary to manually change between the high beams and low beams.

- When there are lights similar to headlights or tail lights in the surrounding area
- When headlights or tail lights of vehicles ahead are turned off, dirty, changing color, or not aimed properly
- When the headlights are repeatedly changing between the high beams and low beams.
- When use of the high beams is inappropriate or when the high beams may be flashing or dazzling pedestrians or other drivers.
- When the vehicle is used in an area in which vehicles travel on the opposite side of the road of the country for which the vehicle was designed, for example using a vehicle designed for right-hand traffic in a left-hand traffic area, or vice versa
- When it is necessary to disable the system: →P.165
- Situations in which the sensors may not operate properly: →P.168

Turning the high beams on/off manually

■ Changing to the high beams

Push the lever forward.

The Automatic High Beam indicator will turn off and the high beam indicator will turn on.

Pull the lever to its original position to enable the Automatic High Beam system again.

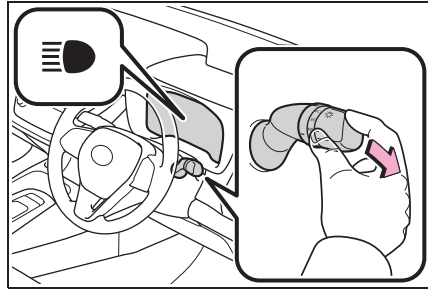

■ Changing to the low beams

Press the Automatic High Beam switch.

The Automatic High Beam indicator will turn off.

Press the switch to enable the Automatic High Beam system again.

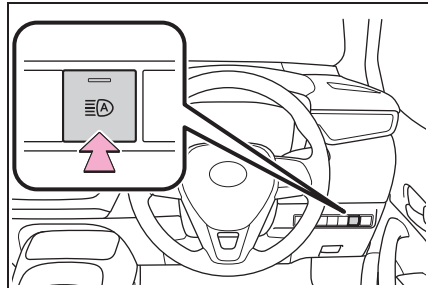

■ Temporarily changing to the low beams

It is recommended to switch to the low beams when use of the high beams is inappropriate or when the high beams may cause problems or distress to other drivers or pedestrians nearby.

Pull the lever rearward and then return it to its original position.

The high beams will illuminate while the lever is pulled, however, after the lever is returned to its original position, the low beams will remain on for a certain

amount of time. After this, the Automatic High Beam system will operate.

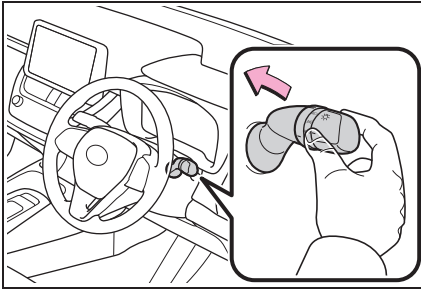

Fog light switch

The fog light secure excellent visibility in difficult driving conditions, such as in rain and fog.

Operating instructions

Turns the rear fog light on.
Releasing the switch ring returns it to .

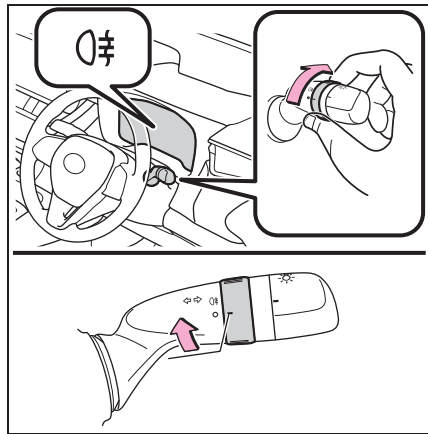

■ Fog light can be used when

The headlights or the front position lights are turned on.

Windshield wipers and washer

Operating the lever can use the windshield wipers or the washer.

NOTICE

■ **When the windshield is dry**
Do not use the wipers, as they may damage the windshield.

Operating the wiper lever

Operating the  lever operates the wipers or washer as follows.

- ▶ Intermittent windshield wipers with interval adjuster

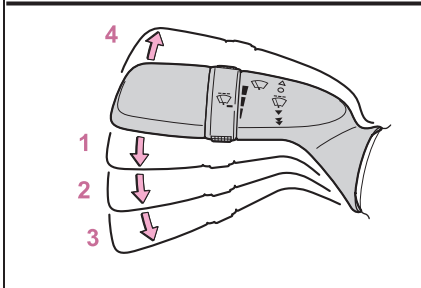
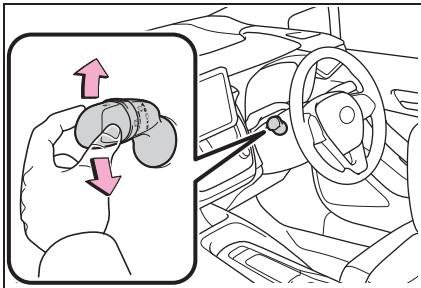

- 1  Intermittent windshield wiper operation

- 2 ▼ Low speed windshield wiper operation
- 3 ▾ High speed windshield wiper operation
- 4 ▲ Temporary operation

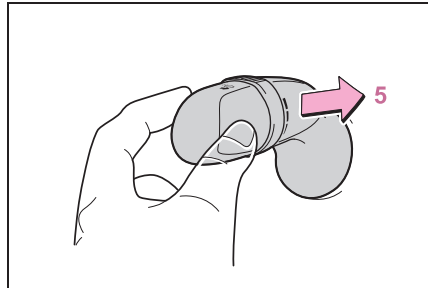

- 5  Washer/wiper dual operation

Pulling the lever operates the wipers and washer.

Wipers will automatically operate a couple of times after the washer squirts.

Wiper intervals can be adjusted when intermittent operation is selected.

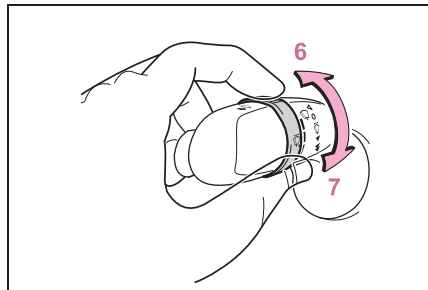

- 6 Increases the intermittent windshield wiper frequency
- 7 Decreases the intermittent windshield wiper frequency

► Rain-sensing windshield wipers

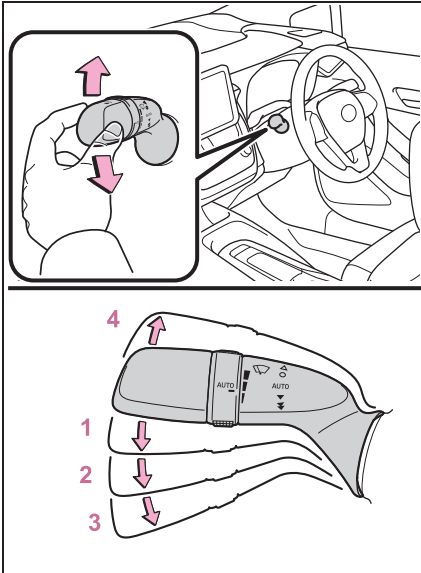

- 1 AUTO Rain-sensing windshield wiper operation
- 2 ▼ Low speed windshield wiper operation
- 3 ▼ High speed windshield wiper operation
- 4 ▲ Temporary operation

When “AUTO” is selected, the wipers will operate automatically when the sensor detects falling rain. The system automatically adjusts wiper timing in accordance with rain volume and vehicle speed.

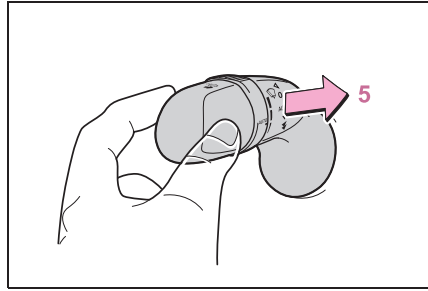

- 5  Washer/wiper dual operation

Pulling the lever operates the wipers and washer.

Wipers will automatically operate a couple of times after the washer squirts.

When “AUTO” is selected, the sensor sensitivity can be adjusted as follows by turning the switch ring.

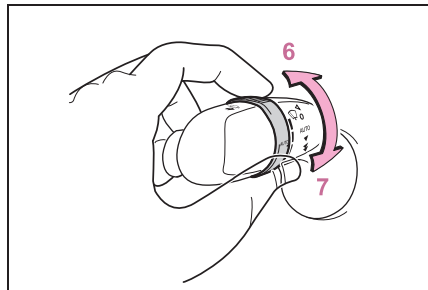

- 6 Increases the rain-sensing windshield wiper sensitivity
- 7 Decreases the rain-sensing windshield wiper sensitivity

■ **The windshield wiper and washer can be operated when**

The power switch is in ON.

■ **Effects of vehicle speed on wiper operation (vehicles with rain-sensing windshield wipers)**

Vehicle speed affects the Intermittent wiper interval.

■ Raindrop sensor (vehicles with rain-sensing windshield wipers)

- The raindrop sensor judges the amount of raindrops. An optical sensor is adopted. It may not operate properly when sunlight from the rising or setting of the sun intermittently strikes the windshield, or if bugs etc. are present on the windshield.

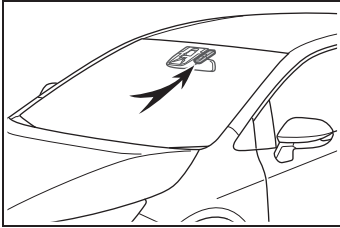

- If the wiper is turned to AUTO mode while the power switch is in ON, the wipers will operate once to show that AUTO mode is activated.
- If the temperature of the raindrop sensor is 85°C (185°F) or higher, or -15°C (5°F) or lower, automatic operation may not occur. In this case, operate the wipers in any mode other than AUTO mode.

■ If no windshield washer fluid sprays

Check that the washer nozzles are not blocked if there is washer fluid in the windshield washer fluid reservoir.

■ Front door opening linked windshield wiper stop function (vehicles with rain-sensing windshield wipers)

When AUTO mode is selected and the windshield wipers are operating, if a front door is opened while the vehicle is stopped and the P shift position is selected, operation of the windshield wipers will be stopped to prevent anyone near the vehicle from being sprayed by water from the wipers. When the front door is closed, wiper operation will resume.

■ When stopping the hybrid system in an emergency while driving

If the windshield wipers are operating when the hybrid system is stopped, the windshield wipers will operate in high speed operation. After the vehicle is stopped, operation will return to normal when the power switch is turned to ON.

⚠ WARNING

■ Caution regarding the use of windshield wipers in AUTO mode (vehicles with rain-sensing windshield wipers)

The windshield wipers may operate unexpectedly if the sensor is touched or the windshield is subject to vibration in AUTO mode. Take care that your fingers or anything else do not become caught in the windshield wipers.

■ Caution regarding the use of washer fluid

When it is cold, do not use the washer fluid until the windshield becomes warm. The fluid may freeze on the windshield and cause low visibility. This may lead to an accident, resulting in death or serious injury.

⚠ NOTICE

■ When there is no washer fluid spray from the nozzle

Damage to the washer fluid pump may be caused if the lever is pulled toward you and held continually.

■ When a nozzle becomes blocked

In this case, contact your Toyota dealer. Do not try to clear it with a pin or other object. The nozzle will be damaged.

Opening the fuel tank cap

Perform the following steps to open the fuel tank cap:

Before refueling the vehicle

- Turn the power switch off and ensure that all the doors and windows are closed.
- Confirm the type of fuel.

Fuel types

→P.345

Fuel tank opening for unleaded gasoline

To help prevent incorrect fueling, your vehicle has a fuel tank opening that only accommodates the special nozzle on unleaded fuel pumps.



WARNING

When refueling the vehicle

Observe the following precautions while refueling the vehicle. Failure to do so may result in death or serious injury.

- After exiting the vehicle and before opening the fuel door, touch an unpainted metal surface to discharge any static electricity. It is important to discharge static electricity before refueling because sparks resulting from static electricity can cause fuel vapors to ignite while refueling.

- Always hold the grips on the fuel tank cap and turn it slowly to remove it.
A whooshing sound may be heard when the fuel tank cap is loosened. Wait until the sound cannot be heard before fully removing the cap. In hot weather, pressurized fuel may spray out the filler neck and cause injury.
- Do not allow anyone that has not discharged static electricity from their body to come close to an open fuel tank.
- Do not inhale vaporized fuel. Fuel contains substances that are harmful if inhaled.
- Do not smoke while refueling the vehicle. Doing so may cause the fuel to ignite and cause a fire.
- Do not return to the vehicle or touch any person or object that is statically charged. This may cause static electricity to build up, resulting in a possible ignition hazard.

When refueling

Observe the following precautions to prevent fuel overflowing from the fuel tank:

- Securely insert the fuel nozzle into the fuel filler neck.
- Stop filling the tank after the fuel nozzle automatically clicks off.
- Do not top off the fuel tank.

**NOTICE****Refueling**

Do not spill fuel during refueling. Doing so may damage the vehicle, such as causing the emission control system to operate abnormally or damaging fuel system components or the vehicle's painted surface.

Opening the fuel tank cap

- 1 Pull up the opener to open the fuel filler door.

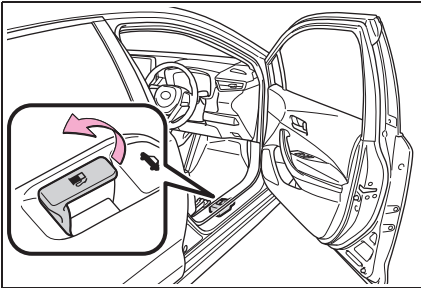

- 2 Turn the fuel tank cap slowly and remove it, then hang it on the back of the fuel filler door.

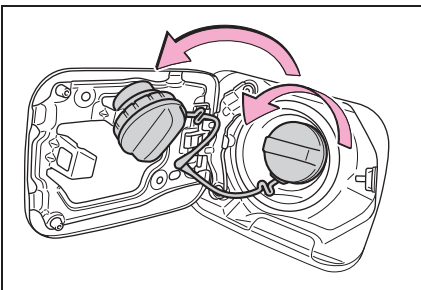
**Closing the fuel tank cap**

After refueling, turn the fuel tank cap until you hear a click. Once the cap is released, it will turn slightly in the opposite direction.

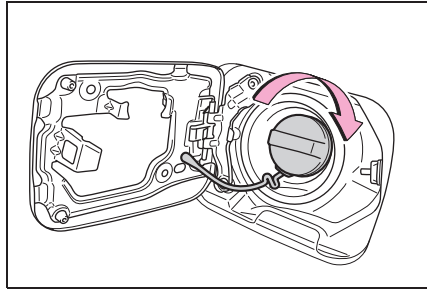
**WARNING****When replacing the fuel tank cap**

Do not use anything but a genuine Toyota fuel tank cap designed for your vehicle. Doing so may cause a fire or other incident which may result in death or serious injury.

Toyota Safety Sense

The Toyota Safety Sense consists of the driving assist systems and contributes to a safe and comfortable driving experience:



WARNING

■ Toyota Safety Sense

The Toyota Safety Sense operates under the assumption that the driver will drive safely, and is designed to help reduce the impact to the occupants in a collision and assist the driver under normal driving conditions.

As there is a limit to the degree of recognition accuracy and control performance that this system can provide, do not overly rely on this system. The driver is solely responsible for paying attention to the vehicle's surroundings and driving safely.

■ For safe use

- Do not overly rely on this system. The driver is solely responsible for paying attention to the vehicle's surroundings and driving safely. This system may not operate in all situations and provided assistance is limited. Over-reliance on this system to drive the vehicle safely may lead to an accident resulting in death or serious injury.
- Do not attempt to test the operation of the system, as it may not operate properly, possibly leading to an accident.
- If attention is necessary while performing driving operations or a system malfunction occurs, a warning message or warning buzzer will be operated. If a warning message is displayed on the display, follow the instructions displayed.

- Depending on external noise, the volume of the audio system, etc. it may be difficult to hear the warning buzzer. Also, depending on the road conditions, it may be difficult to recognize the operation of the system.

■ When it is necessary to disable the system

In the following situations, make sure to disable the system.

Failure to do so may lead to the system not operating properly, possibly leading to an accident resulting in death or serious injury.

- When the vehicle is tilted due to being overloaded or having a flat tire
- When driving at extremely high speeds
- When towing another vehicle
- When the vehicle is being transported by a truck, ship, train, etc.
- When the vehicle is raised on a lift and the tires are allowed to rotate freely
- When inspecting the vehicle using a drum tester such as a chassis dynamometer or speedometer tester, or when using an on vehicle wheel balancer
- When the vehicle is driven in a sporty manner or off-road
- When using an automatic car wash
- When a sensor is misaligned or deformed due to a strong impact being applied to the sensor or the area around the sensor
- When accessories which obstruct a sensor or light are temporarily installed to the vehicle

**WARNING**

- When a compact spare tire or tire chains are installed to the vehicle or an emergency tire puncture repair kit has been used
- When the tires are excessively worn or the inflation pressure of the tires is low
- When tires other than the manufacturer specified size are installed
- When the vehicle cannot be driven stably, due to a collision, malfunction, etc.

Driving assist system■ **PCS (Pre-Collision System)**

→P.171

■ **LTA (Lane Tracing Assist)**

→P.181

■ **LDA (Lane Departure Alert)**

→P.186

■ **Emergency Driving Stop System**

→P.191

■ **AHB (Automatic High Beam)**

→P.156

■ **RSA (Road Sign Assist)**

→P.193

■ **Dynamic radar cruise control**

→P.195

■ **Cruise control**

→P.204

Sensors used by Toyota Safety Sense

Various sensors are used to obtain the necessary information for system operation.

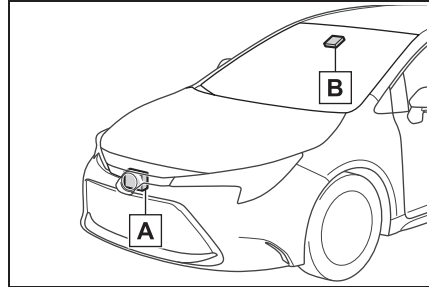
■ **Sensors which detect the surrounding conditions**

[A] Front radar sensor

[B] Front camera

**WARNING**■ **To prevent malfunction of the radar sensors**

Observe the following precautions. Failure to do so may lead to a radar sensor not operating properly, possibly leading to an accident resulting in death or serious injury.

⚠ WARNING

- Keep the radar sensors and radar sensor covers clean at all times.

Clean the front of a radar sensor or the front or back of a radar sensor cover if it is dirty or covered with water droplets, snow, etc.

When cleaning the radar sensor and radar sensor cover, use a soft cloth to remove dirt so as to not damage them.

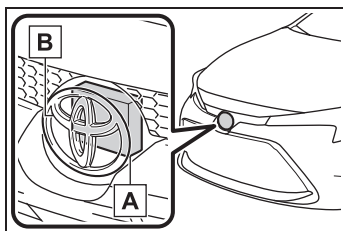

A Radar sensor

B Radar sensor cover

- Do not attach accessories, stickers (including transparent stickers), aluminum tape, etc. to a radar sensor or radar sensor cover and their surrounding area.
- Do not subject a radar sensor or its surrounding area to impact. If a radar sensor, the front grille, or front bumper has been subjected to a impact, have the vehicle inspected by your Toyota dealer.
- Do not disassemble the radar sensors.
- Do not modify or paint the radar sensors or radar sensor cover, or replace them with anything other than Toyota genuine parts.
- In the following situations, recalibration of the radar sensors will be necessary. For details, contact your Toyota dealer.
 - When a radar sensor is removed and installed, or replaced

- When the front bumper or the front grille has been replaced

■ To prevent malfunction of the front camera

Observe the following precautions. Failure to do so may lead to the front camera not operating properly, possibly leading to an accident resulting in death or serious injury.

- Always keep the windshield clean.
- If the windshield is dirty or covered with an oily film, water droplets, snow, etc., clean the windshield.
- Even if a glass coating agent is applied to the windshield, it will still be necessary to use the windshield wipers to remove water droplets, etc. from the area of the windshield in front of the front camera.
- If the inner side of the windshield where the front camera is installed is dirty, contact your Toyota dealer.
- Do not attach stickers (including transparent stickers) or other items to the area of the windshield in front of the front camera (shaded area in the illustration).

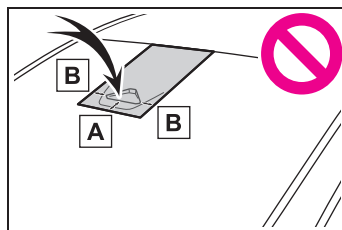

A Approximately 4 cm (1.6 in.)

B Approximately 4 cm (1.6 in.)

- If the part of the windshield in front of the front camera is fogged up or covered with condensation or ice, use the windshield defogger to remove the fog, condensation, or ice.

**WARNING**

- If water droplets cannot be properly removed from the area of the windshield in front of the front camera by the windshield wipers, replace the wiper insert or wiper blade.
- Do not attach window tint to the windshield.
- Replace the windshield if it is damaged or cracked.
If the windshield has been replaced, recalibration of the front camera will be necessary. For details, contact your Toyota dealer.
- Do not allow liquids to contact the front camera.
- Do not allow bright lights to shine into the front camera.
- Do not damage the lens of the front camera or allow it to become dirty.
When cleaning the inside of the windshield, do not allow glass cleaner to contact the lens of the front camera. Do not touch the lens of the front camera.
If the lens of the front camera is dirty or damaged, contact your Toyota dealer.
- Do not subject the front camera to a strong impact.
- Do not change the position or orientation of the front camera or remove it.
- Do not disassemble the front camera.
- Do not modify any parts around the front camera, such as the inside rear view mirror or ceiling.
- Do not attach accessories which may obstruct the front camera to the hood, front grille, or front bumper. For details, contact your Toyota dealer.

- If a surfboard or other long object is to be mounted on the roof, make sure that it will not obstruct the front camera.

- Do not modify or change the headlights and other lights.

■ Front camera installation area on the windshield

If the system determines that the windshield may be fogged up, it will automatically operate the heater to defog the part of the windshield around the front camera. When cleaning, etc., be careful not to touch the area around the front camera until the windshield has cooled sufficiently, as touching it may cause burns.

■ Situations in which the sensors may not operate properly

- When the height or inclination of the vehicle has been changed due to modifications
- When the windshield is dirty, fogged up, cracked or damaged
- When the ambient temperature is high or low
- When mud, water, snow, dead insects, foreign matter, etc., is attached to the front of the sensor
- When in inclement weather such as heavy rain, fog, snow, or a sandstorm
- When water, snow, dust, etc. is thrown up in front of the vehicle, or when driving through mist or smoke
- When the headlights are not illuminated while driving in the dark, such as at night or when in a tunnel
- When the lens of a headlight is dirty and illumination is weak
- When the headlights are misaligned
- When a headlight is malfunctioning
- When the headlights of another vehicle, sunlight, or reflected light shines directly into the front camera

- When the brightness of the surrounding area changes suddenly
- When driving near a TV tower, broadcasting station, electric power plant, radar equipped vehicles, etc., or other location where strong radio waves or electrical noise may be present
- When a wiper blade is blocking the front camera
- When in a location or near objects which strongly reflect radio waves, such as the following:
 - Tunnels
 - Truss bridges
 - Gravel roads
 - Rutted, snow-covered roads
 - Walls
 - Large trucks
 - Manhole covers
 - Guardrail
 - Metal plates
- When near a step or protrusion
- When a detectable vehicle is narrow, such as a small mobility vehicle
- When a detectable vehicle has a small front or rear end, such as an unloaded truck
- When a detectable vehicle has a low front or rear end, such as a low bed trailer

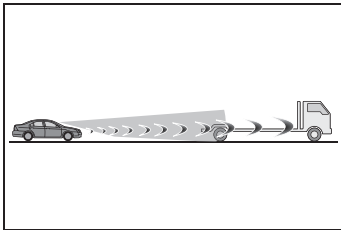

- When a detectable vehicle has extremely high ground clearance

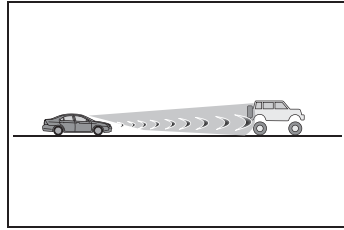

- When a detectable vehicle is carrying a load which protrudes from its cargo area
- When a detectable vehicle has little exposed metal, such as a vehicle which is partially covered with cloth, etc.
- When a detectable vehicle is irregularly shaped, such as a tractor, side-car, etc.
- When the distance between the vehicle and a detectable vehicle has become extremely short
- When a detectable vehicle is at an angle
- When snow, mud, etc. is attached to a detectable vehicle
- When driving on the following kinds of roads:
 - Roads with sharp curves or winding roads
 - Roads with changes in grade, such as sudden inclines or declines
 - Roads which is sloped to the left or right
 - Roads with deep ruts
 - Roads which are rough and unmaintained
 - Roads which frequently undulate or are bumpy
- When the steering wheel is being operated frequently or suddenly
- When the vehicle is not in a constant position within a lane
- When parts related to this system, the brakes, etc. are cold or extremely hot, wet, etc.
- When the wheels are misaligned
- When driving on slick road surfaces,

such as when it is covered with ice, snow, gravel, etc.

- When the course of the vehicle differs from the shape of a curve
- When the vehicle speed is excessively high when entering a curve
- When entering/exiting a parking lot, garage, car elevator, etc.
- When driving in a parking lot
- When driving through an area where there are obstructions which may contact your vehicle, such as tall grass, tree branches, a curtain, etc.
- When driving in strong wind

■ **Situations in which the lane may not be detected**

- When the lane is extremely wide or narrow
- Immediately after changing lanes or passing through an intersection
- When driving in a temporary lane or lane regulated by construction
- When there are structures, patterns, shadows which are similar to lane lines in the surrounding
- When the lane lines are not clear or driving on a wet road surface
- When a lane line is on a curb
- When driving on a bright, reflective road surface, such as concrete

■ **Situations in which some or all of the functions of the system cannot operate**

- When a malfunction is detected in this system or a related system, such as the brakes, steering, etc.
- When the VSC, TRC, or other safety related system is operating
- When the VSC, TRC, or other safety related system is off

■ **Changes in brake operation sound and pedal response**

- When the brakes have been operated, brake operation sounds may be heard

and the brake pedal response may change, but this does not indicate a malfunction.

- When the system is operating, the brake pedal may feel stiffer than expected or sink. In either situation the brake pedal can be depressed further. Further depress the brake pedal as necessary.

PCS (Pre-Collision System)

The pre-collision system uses sensors to detect objects (→P.171) in the path of the vehicle. When the system determines that the possibility of a frontal collision with a detectable object is high, a warning operates to urge the driver to take evasive action and the potential brake pressure is increased to help the driver avoid the collision. If the system determines that the possibility of a collision is extremely high, the brakes are automatically applied to help avoid the collision or help reduce the impact of the collision.

The pre-collision system can be disabled/enabled and the warning timing can be changed. (→P.180)

WARNING

■ For safe use

- Driving safely is solely the responsibility of the driver. Pay careful attention to the surrounding conditions in order to ensure safe driving. Never use the pre-collision system in place of normal braking operations. This system cannot help avoid or reduce the impact of a collision in every situation. Over-reliance on this system to drive the vehicle safely may lead to an accident resulting in death or serious injury.

- Although the pre-collision system is designed to help avoid or help reduce the impact of a collision, its effectiveness may change according to various conditions. Therefore, it may not always be able to achieve the same level of performance. Read the following items carefully. Do not overly rely on this system and always drive carefully.

- For safe use: →P.165

■ When to disable the pre-collision system

- When it is necessary to disable the system: →P.165

Detectable objects

The system can detect the following as detectable objects. (Detectable objects differ depending on the function.)

- Vehicles
- Bicycles*
- Pedestrians
- Motorcycles*

*: Detected as a detectable object only

when being ridden.

System functions

■ Pre-collision warning

When the system determines that the possibility of a collision is high, a buzzer will sound and an icon and warning message will be displayed on the multi-information display to urge the driver to take evasive action.

If the detectable object is a vehicle, moderate braking will be performed with the warning.

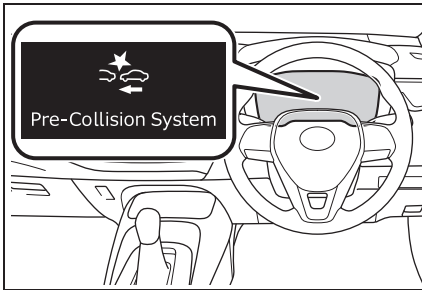

If the system determines that the accelerator pedal is strongly depressed, the following icon and message will be displayed on the multi-information display.

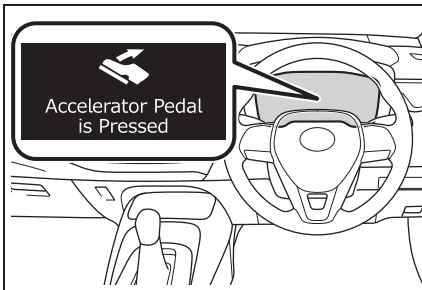

■ Pre-collision brake assist

If the system determines that the possibility of a collision is high and the brake operation by the driver is insufficient, the braking power will be increased.

■ Pre-collision brake control

If the system determines that the possibility of a collision is extremely high, the brakes are automatically applied to help avoid the collision or reduce the impact of the collision.

■ Emergency steering assist

If the system determines that the following conditions are met, assistance will be provided to help enhance vehicle stability and prevent lane departure. During assistance, in addition to the pre-collision warning, the following icon will be displayed on the multi-information display.

- The possibility of a collision is high
- There is sufficient space within the lane to perform evasive steering maneuvers
- The driver is operating the steering wheel

During assistance, the pre-collision warning will operate and a message will be displayed to warn the driver.

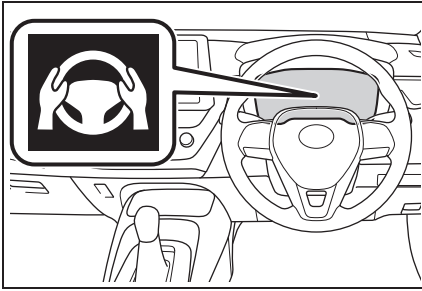

■ Intersection collision avoidance support (left/right turn)

In situations such as the following, if the system determines that the possibility of a collision is high, the pre-collision warning and pre-collision braking will operate.

Depending on the intersection, assistance may not operate correctly.

- When turning left/right at an intersection and crossing the path of an oncoming vehicle

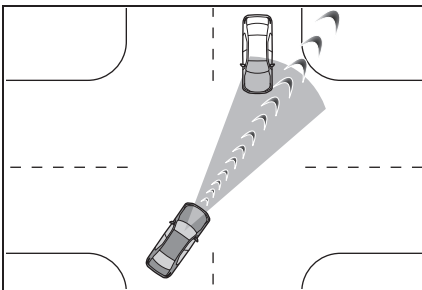

- When turning left/right and an oncoming pedestrian or bicycle is detected

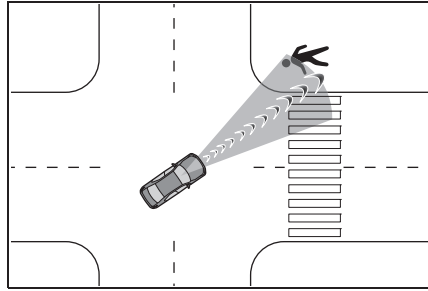

■ Intersection collision avoidance support (crossing vehicles)

At an intersection, etc., if the system determines that the possibility of a collision with an approaching vehicle or motorcycle is high, the pre-collision warning and pre-collision braking will operate.

Depending on the intersection, assistance may not operate correctly.

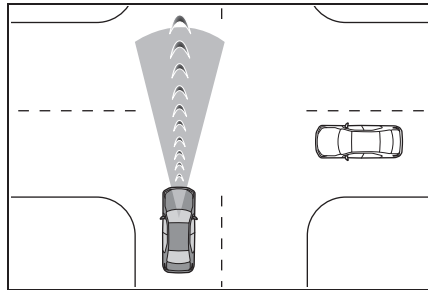

■ Acceleration Suppression at Low Speed

When driving at a low speed, if the accelerator pedal is strongly depressed and the system determines that there is a possibility of a collision, hybrid system output will be restrained or the brakes will be applied weakly to restrict acceleration.

tion. During operation, a buzzer will sound and a warning indicator and message will be displayed on the multi-information display.

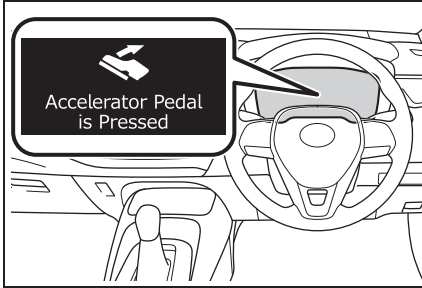

WARNING

■ Pre-collision braking

- When the pre-collision braking function is operating, a large amount of braking force will be applied.
- The pre-collision braking function is not designed to hold the vehicle stopped. If the vehicle is stopped by pre-collision brake control, the driver should operate the brakes immediately as necessary.
- The pre-collision braking function may not operate if certain operations are performed by the driver. If the accelerator pedal is being depressed strongly or the steering wheel is being turned, the system may determine that the driver is taking evasive action and possibly prevent the pre-collision braking function from operating.
- If the brake pedal is being depressed, the system may determine that the driver is taking evasive action and possibly delay the operation timing of the pre-collision brake control.

■ Acceleration Suppression at Low Speed

If the steering wheel is being turned, the system may determine that the driver is taking evasive action and possibly prevent the Acceleration Suppression at Low Speed function from operating.

■ Emergency steering assist

- The emergency steering assist will be canceled when the system determines that lane departure prevention control has completed.
- Depending on operations performed by the driver, emergency steering assist may not operate or operation may be canceled.
- If the accelerator pedal is depressed strongly, the steering wheel is turned heavily, the brake pedal is depressed, or the turn signal lever is operated, the system may determine that the driver is taking evasive action and the emergency steering assist may not operate.
- While the emergency steering assist is operating, if the accelerator pedal is depressed strongly, the steering wheel is turned heavily, or the brake pedal is depressed, the system may determine that the driver is taking evasive action and emergency steering assist operation may be canceled.
- While the emergency steering assist is operating, if the steering wheel is held or turned in the opposite direction of system operation, emergency steering assist operation will be canceled.

■ Operating conditions of each function of the pre-collision system

The pre-collision system is enabled and the system determines that the possibility of a frontal collision with a detected object is high.

However, the system will not operate in the following situations:

- When the vehicle has not been driven a certain amount after a terminal of the 12-volt battery has been disconnected and reconnected
- When the shift lever is in R
- When the VSC OFF indicator is illuminated (only the pre-collision warning function will be operational)

The following are the operational speeds and cancelation conditions of each function:

- Pre-collision warning

Detectable objects	Vehicle speed	Relative speed between your vehicle and object
Preceding vehicles, stopped vehicles	Approximately 5 to 180 km/h (3 to 110 mph)	Approximately 5 to 180 km/h (3 to 110 mph)
Oncoming vehicles	Approximately 30 to 180 km/h (20 to 110 mph)	Approximately 80 to 220 km/h (50 to 130 mph)
Bicycles	Approximately 5 to 80 km/h (3 to 50 mph)	Approximately 5 to 80 km/h (3 to 50 mph)
Pedestrians	Approximately 5 to 80 km/h (3 to 50 mph)	Approximately 5 to 80 km/h (3 to 50 mph)
Preceding motorcycles, stopped motorcycles	Approximately 5 to 180 km/h (3 to 110 mph)	Approximately 5 to 80 km/h (3 to 50 mph)
Oncoming motorcycles	Approximately 30 to 180 km/h (20 to 110 mph)	Approximately 30 to 180 km/h (20 to 110 mph)

While the pre-collision warning is operating, if the steering wheel is operated heavily or suddenly, the pre-collision warning may be cancelled.

- Pre-collision brake assist

Detectable objects	Vehicle speed	Relative speed between your vehicle and object
Preceding vehicles, stopped vehicles	Approximately 30 to 180 km/h (20 to 110 mph)	Approximately 10 to 180 km/h (7 to 110 mph)
Bicycles	Approximately 30 to 80 km/h (20 to 50 mph)	Approximately 30 to 80 km/h (20 to 50 mph)

Detectable objects	Vehicle speed	Relative speed between your vehicle and object
Pedestrians	Approximately 30 to 80 km/h (20 to 50 mph)	Approximately 30 to 80 km/h (20 to 50 mph)
Preceding motorcycles, stopped motorcycles	Approximately 30 to 180 km/h (20 to 110 mph)	Approximately 10 to 80 km/h (7 to 50 mph)

● Pre-collision braking

Detectable objects	Vehicle speed	Relative speed between your vehicle and object
Preceding vehicles, stopped vehicles	Approximately 5 to 180 km/h (3 to 110 mph)	Approximately 5 to 180 km/h (3 to 110 mph)
Oncoming vehicles	Approximately 30 to 180 km/h (20 to 110 mph)	Approximately 80 to 220 km/h (50 to 130 mph)
Bicycles	Approximately 5 to 80 km/h (3 to 50 mph)	Approximately 5 to 80 km/h (3 to 50 mph)
Pedestrians	Approximately 5 to 80 km/h (3 to 50 mph)	Approximately 5 to 80 km/h (3 to 50 mph)
Preceding motorcycles, stopped motorcycles	Approximately 5 to 180 km/h (3 to 110 mph)	Approximately 5 to 80 km/h (3 to 50 mph)
Oncoming motorcycles	Approximately 30 to 180 km/h (20 to 110 mph)	Approximately 30 to 180 km/h (20 to 110 mph)

If either of the following occur while the pre-collision braking function is operating, it will be canceled:

- The accelerator pedal is strongly depressed
- The steering wheel is operated heavily or suddenly

● Emergency steering assist

The emergency steering assist will not operate when the turn signal lights are flashing.

The emergency steering assist will not operate when the VSC OFF indicator is illuminated.

Detectable objects	Vehicle speed	Relative speed between your vehicle and object
Preceding vehicles, stopped vehicles, bicycles, pedestrians, motorcycles	Approximately 40 to 80 km/h (25 to 50 mph) Active steering function: * to 80 km/h (* to 50 mph)	Approximately 40 to 80 km/h (25 to 50 mph) Active steering function: * to 80 km/h (* to 50 mph)

*: Minimum vehicle speed: Vehicle speed at which evasion using pre-collision brake

control is difficult

While the emergency steering assist is operating, if any of the following are performed, emergency steering assist operation may be cancelled:

- The accelerator pedal is strongly depressed
- The steering wheel is operated heavily or suddenly
- The brake pedal is depressed
- Intersection collision avoidance support (left/right turn)

The intersection collision avoidance support (for left/right turning vehicles) will not operate when the turn signal lights are not flashing.

Detectable objects	Vehicle speed	Oncoming vehicle speed	Relative speed between your vehicle and object
Oncoming vehicles	Approximately 5 to 40 km/h (3 to 25 mph)	Approximately 5 to 75 km/h (3 to 45 mph)	Approximately 10 to 115 km/h (7 to 70 mph)
Pedestrians	Approximately 5 to 30 km/h (3 to 20 mph)	—	Approximately 5 to 40 km/h (3 to 25 mph)
Bicycles	Approximately 5 to 30 km/h (3 to 20 mph)	—	Approximately 5 to 50 km/h (3 to 30 mph)
Oncoming motorcycles	Approximately 5 to 40 km/h (3 to 25 mph)	Approximately 5 to 75 km/h (3 to 45 mph)	Approximately 10 to 115 km/h (7 to 70 mph)

- Intersection collision avoidance support (crossing vehicles)

Detectable objects	Vehicle speed	Crossing vehicle speed	Relative speed between your vehicle and object
Vehicles (side)	Approximately 5 to 60 km/h (3 to 38 mph)	<ul style="list-style-type: none"> • Your vehicle speed or less • Approximately 40 km/h (25 mph) or less 	Approximately 5 to 60 km/h (3 to 38 mph)
Motorcycles (side)	Approximately 5 to 60 km/h (3 to 38 mph)	<ul style="list-style-type: none"> • Your vehicle speed or less • Approximately 40 km/h (25 mph) or less 	Approximately 5 to 60 km/h (3 to 38 mph)

- Acceleration Suppression at Low Speed

The Acceleration Suppression at Low Speed function will not operate when the turn signal lights are flashing.

Detectable objects	Vehicle speed	Relative speed between your vehicle and object
Preceding vehicles, stopped vehicles	Approximately 0 to 15 km/h (0 to 9 mph)	Approximately 0 to 15 km/h (0 to 9 mph)
Pedestrians	Approximately 0 to 15 km/h (0 to 9 mph)	Approximately 0 to 15 km/h (0 to 9 mph)
Bicycles	Approximately 0 to 15 km/h (0 to 9 mph)	Approximately 0 to 15 km/h (0 to 9 mph)

While the Acceleration Suppression at Low Speed function is operating, if any of the following are performed, the low speed sudden acceleration suppression function operation will be cancelled:

- The accelerator pedal is released
- The steering wheel is operated heavily or suddenly

■ Detection of detectable objects

Objects are detected based on their size, shape, and movement. Depending on the ambient brightness, movement, posture and direction of a detectable object, it may not be detected and the system may not operate properly.

The system detects shapes, such as the following, as detectable objects.

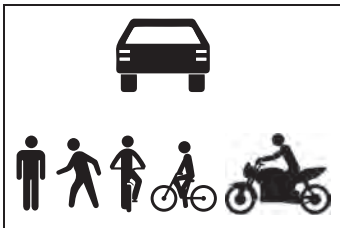

■ Situations in which the system may operate even though the possibility of a collision is not high

- In certain situations, such as the following, the system may determine that the possibility of a collision is high and operate:
 - When passing a detectable object
 - When changing lanes while overtaking a detectable object
 - When suddenly approaching a detect-

- able object
 - When approaching a detectable object or other object on the roadside, such as guardrails, utility poles, trees, walls, etc.
 - When there is a detectable object or other object by the roadside at the entrance of a curve

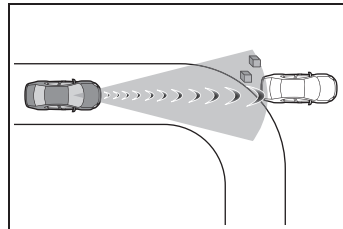

- When there are patterns or a painting ahead of the vehicle that may be mistaken for a detectable object
- When passing a detectable object that is changing lanes or turning left/right

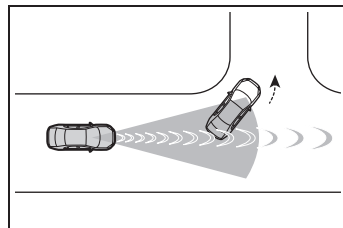

- When passing a detectable object which is stopped to make a left/right turn

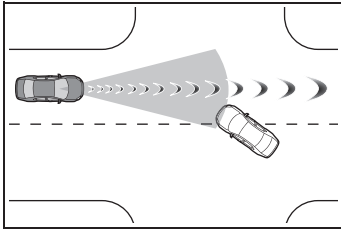

- When a detectable object stops immediately before entering the path of the vehicle
- When passing through a location with a structure above the road (traffic sign, billboard, etc.)

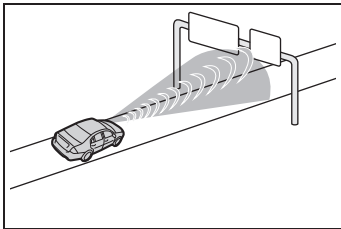

- When approaching an electric toll gate barrier, parking lot barrier, or other barrier that opens and closes
- When turning left/right and an oncoming vehicle or pedestrian crosses in front of the vehicle
- When attempting to turn left/right in front of an oncoming vehicle or pedestrian
- When turning left/right and an oncoming vehicle or pedestrian stops immediately before entering the path of the vehicle
- When turning left/right and an oncoming vehicle turns left/right in front of the vehicle

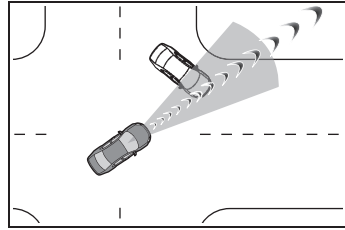

- When the steering wheel is operated toward the path of an oncoming vehicle

■ Situations in which the system may not operate properly

- In certain situations, such as the following, a detectable object may not be detected by the front sensors, and the system may not operate properly:
 - When a detectable object is approaching your vehicle
 - When your vehicle or a detectable object is wandering
 - When a detectable object makes an abrupt maneuver (such as sudden swerving, acceleration or deceleration)
 - When suddenly approaching a detectable object
 - When the detectable object is near a wall, fence, guardrail, manhole cover, steel plate on the road surface, or another vehicle
 - When there is a structure above a detectable object
 - When part of a detectable object is hidden by another object (large luggage, umbrella, guardrail, etc.)
 - When multiple detectable objects are overlapping
 - When a bright light, such as the sun, is reflecting off of a detectable object
 - When a detectable object is white and looks extremely bright
 - When the color or brightness of a detectable object causes it to blend in with its surroundings
 - When a detectable object cuts in front of or suddenly emerges in front of your vehicle
 - When approaching a vehicle which is diagonal
 - If a vehicle ahead is a child sized bicy-

cle, is carrying a large load, is carrying an extra passenger, or has an unusual shape (bicycles equipped with a child seat, tandem bicycles, etc.)

- If a pedestrian or bicycle is shorter than approximately 1 m (3.2 ft.) or taller than approximately 2 m (6.5 ft.).
- When the silhouette of a pedestrian or bicycle is unclear (such as when they are wearing a raincoat, long skirt, etc.)
- When a pedestrian or bicycle is bending forward or squatting
- When a pedestrian or bicycle is moving at high speed
- When a pedestrian is pushing a stroller, wheelchair, bicycle or other vehicle
- When a detectable object blends in with the surrounding area, such as when it is dim (at dawn or dusk) or dark (at night or in a tunnel)
- When the vehicle has not been driven for a certain amount of time after the hybrid system was started
- While turning left/right or a few seconds after turning left/right
- While driving around a curve and a few seconds after driving around a curve
- When turning left/right and an oncoming vehicle is driving in a lane 3 or more lanes from the vehicle
- When turning left/right and the direction of the vehicle differs greatly from the direction traffic flows in the oncoming lane

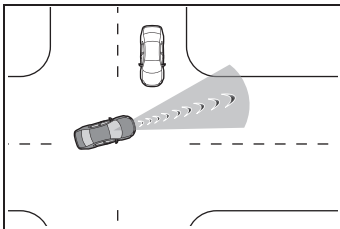

- When turning left/right and approaching a pedestrian which was traveling in the same direction as the vehicle and continues straight

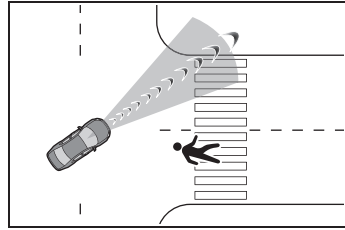

- In addition to the preceding, in certain situations, such as the following, the emergency steering assist may not operate properly:
 - When a detectable object is too close to the vehicle
 - When there is insufficient space to perform evasive steering maneuvers or an obstruction exists in the evasion direction
 - When there is an oncoming vehicle

Changing the pre-collision setting

- The pre-collision system can be enabled/disabled through a customize setting. (→P.346)

The system is enabled each time the power switch is turned to ON.

- When the system is disabled, the PCS warning light will illuminate and a message will be displayed on the multi-information display.

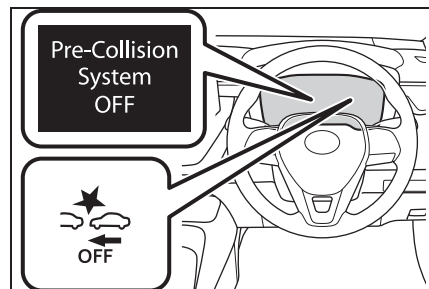

- The pre-collision setting can be changed on the customize set-

tings. (→P.346)

- When the pre-collision warning timing is changed, the emergency steering assist (excluding the active steering function) timing will also be changed. When "Later" is selected, the emergency steering assist (excluding the active steering function) will not operate in most cases.
- When the dynamic radar cruise control is operating, the pre-collision warning will operate at the "Earlier" timing, regardless of the user setting.

LTA (Lane Tracing Assist)

LTA functions

- When driving on a road with clear lane lines with the dynamic radar cruise control operating, lane lines and preceding and surrounding vehicles are detected using the front camera and radar sensor, and the steering wheel is operated to maintain the vehicle's lane position.

Use the this function only on highways and expressways.

If the dynamic radar cruise control is not operating, the function will not operate.

In situations where the lane lines are difficult to see or are not visible, such as when in a traffic jam, support will be provided using the path of preceding and surrounding vehicles.

If the system determines that the steering wheel has not been operated for a certain amount of time or the steering wheel is not being firmly gripped, the driver will be alerted via a display and this function will be temporarily canceled.

If the steering wheel is firmly gripped, the function will begin operating again.

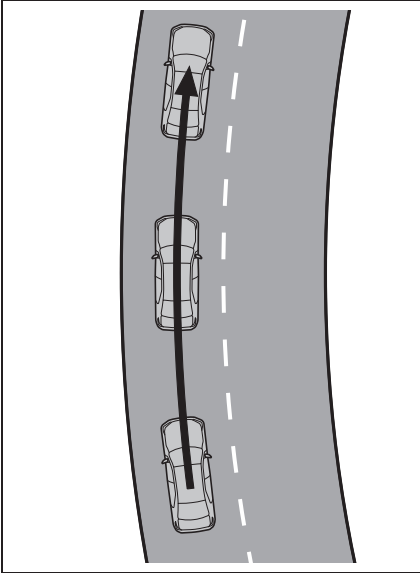

- When the function is operating, if the vehicle is likely to depart from its lane, the driver will be alerted via a display and buzzer.

When the buzzer sounds, check the area around the vehicle and carefully operate the steering wheel to move the vehicle back to the center of the lane.

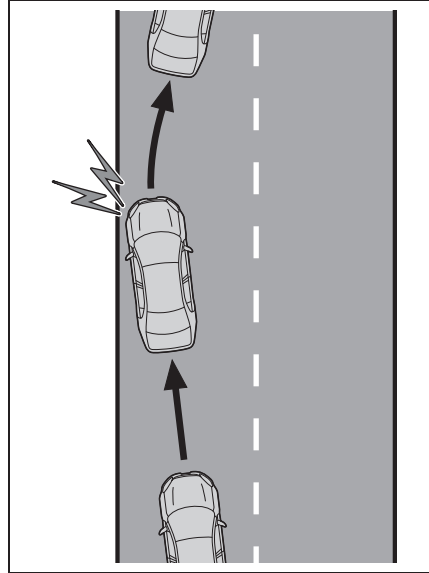

WARNING

Before using the LTA system

- Do not overly rely on the LTA system. The LTA system is not a system which provides automated assistance in driving and it is not a system which reduces the amount of attention necessary for safe driving. The driver is solely responsible for paying attention to their surroundings and operating the steering wheel as necessary to ensure safety. Also, the driver is responsible for taking adequate breaks when fatigued, such as when driving for a long time.
- Failure to perform appropriate driving operations and pay careful attention may lead to an accident.
- When not using the LTA system, turn it off using the LTA switch.

Operating conditions of function

This function is operable when all of the following conditions are met:

- The LTA system detects lane lines or

the path of preceding or surrounding vehicles (except when the preceding vehicle is small, such as a motorcycle).

- The dynamic radar cruise control is operating.
- The lane width is approximately 3 to 4 m (10 to 13 ft.).
- The turn signal lever is not being operated.
- The vehicle is not being driven around a sharp curve.
- The vehicle is not accelerating or decelerating more than a certain amount.
- The steering wheel is not being turned with a large force.
- The hands off steering wheel warning (→P.183) is not operating.
- The vehicle is being driven in the center of a lane.

■ Temporary cancelation of functions

- When the operating conditions are no longer met, a function may be temporarily canceled. However, when the operation conditions are met again, operation of the function will automatically be restored. (→P.182)
- If the operating conditions of a function are no longer met while the function is operating, a buzzer may sound to indicate that the function has been temporarily canceled.
- The steering assist operation of the function can be overridden by the steering wheel operation of the driver.

■ Lane departure warning function when the LTA is operating

- Even if the LDA warning method is changed to vibration of the steering wheel, if the vehicle deviates from the lane while the LTA is operating, the warning buzzer will sound to alert the driver.
- If steering wheel operation equivalent to that necessary for a lane change is

detected, the system will determine the vehicle is not deviating from the lane and the warning will not operate.

■ Hands off steering wheel warning operation

In the following situations, a message urging the driver to grip the steering wheel and the icon shown in the illustration will be displayed on the multi-information display to warn the driver. If the system detects that the steering wheel is held, the warning will be canceled. When using the system, make sure to grip the steering wheel firmly, regardless of whether the warning is operating or not.

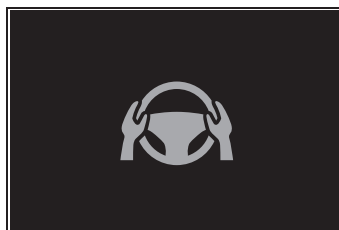

- When the system determines the driver is not holding the steering wheel while the function is operating

If no operations are detected for a certain amount of time, a buzzer will sound, the warning will operate, and the function will be temporarily canceled. This warning may also operate if the driver only operates steering wheel a small amount continuously.

Depending on the condition of the vehicle, handle control condition and road surface, the warning function may not operate.

Enabling/disabling the system

The LTA will change between enabled/disabled each time the LTA switch is pressed.

When the LTA is enabled, the LTA indicator will illuminate.

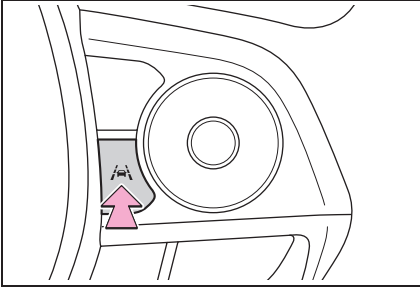

WARNING

■ Situations in which the functions may not operate properly

In the following situations, the functions may not operate properly and the vehicle may depart from its lane. Do not overly rely on these functions. The driver is solely responsible for paying attention to their surroundings and operating the steering wheel as necessary to ensure safety.

- When a preceding or surrounding vehicle changes lanes (Your vehicle may follow the preceding or surrounding vehicle and also change lanes)

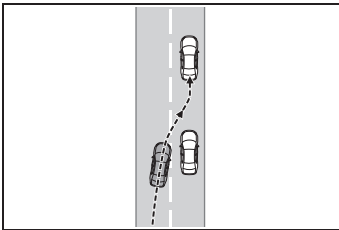









- When a preceding or surrounding vehicle is swaying (Your vehicle may sway accordingly and depart from the lane)

- When a preceding or surrounding vehicle departs from a lane (Your vehicle may follow the preceding or surrounding vehicle and also depart from the lane)
- When a preceding or surrounding vehicle is being driven extremely close to the left/right lane line (Your vehicle may follow the preceding or surrounding vehicle accordingly and depart from the lane)
- When there are moving objects or structures in the surrounding area (Depending on the position of the moving object or structure relative to your vehicle, your vehicle may sway)
- When the vehicle is struck by a crosswind or the turbulence of other nearby vehicles
- Situations in which the sensors may not operate properly: →P.168
- Situations in which the lane may not be detected: →P.170
- When it is necessary to disable the system: →P.165

Operation display of steering wheel operation support

The operating state of the LTA system is indicated.

Indicator	Lane display	Steering icon	Situation
 White	 Gray	 Gray	LTA is on standby
 Green	 Green	 Green	LTA is operating
 Orange Flashing	 Orange Flashing	 Green	The vehicle is departing the lane toward the side which the lane display is flashing

LDA (Lane Departure Alert)

Basic functions

The LDA system warns the driver if the vehicle may deviate from the current lane or course*, and also can slightly operate the steering wheel to help avoid deviation from the lane or course*.

The front camera is used to detect lane lines or a course*.

*: Boundary between the asphalt and grass, soil, etc., or structures, such as a curb, guardrail, etc.

■ Lane departure alert function

When the system determines that the vehicle might depart from its lane or course*, a warning is displayed on a display, and either a warning buzzer will sound or the steering wheel will vibrate to alert the driver.

Check the area around your vehicle and carefully operate the steering wheel to move the vehicle back to the center of the lane or course*.

Vehicles with BSM: If the system determines that the vehicle may collide with a vehicle in an adjacent lane, the lane departure alert will operate even if the turn signals are operating.

*: Boundary between the asphalt and grass, soil, etc., or structures, such as a curb, guardrail, etc.

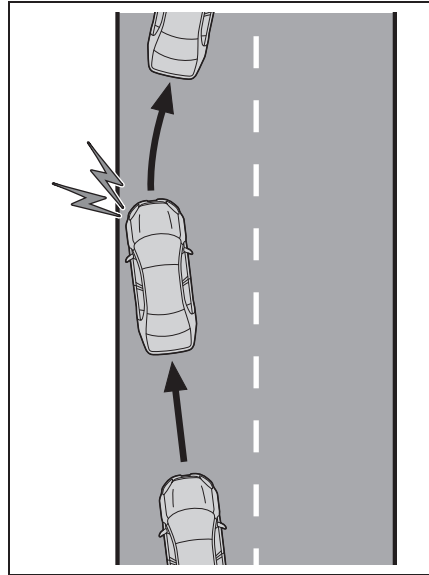

■ Lane departure prevention function

If the system determines that the vehicle is likely to depart from its lane or course*, it provides assistance through steering wheel operations to help avoid deviation from the lane or course.

If the system determines that the steering wheel has not been operated for a certain amount of time or the steering wheel is not being firmly gripped, a warning message may be displayed and a warning buzzer may sound to alert the driver.

Vehicles with BSM: If the system determines that the vehicle may collide with a vehicle in an adjacent lane, the lane departure prevention function will operate even if the turn signals are operating.

*: Boundary between the asphalt and grass, soil, etc., or structures, such

as a curb, guardrail, etc.

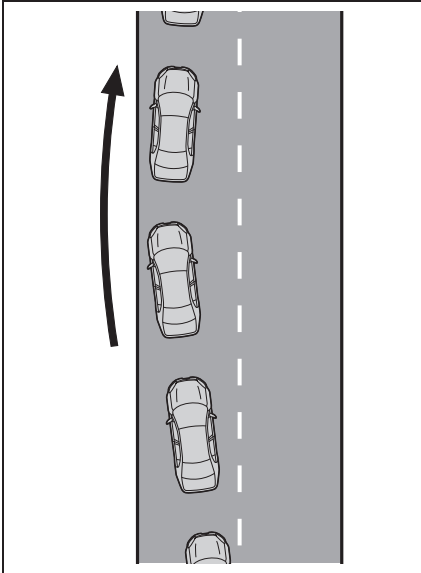

■ Break suggestion function

If the vehicle is swaying, a message will be displayed and a warning buzzer will sound to urge the driver to take a break.

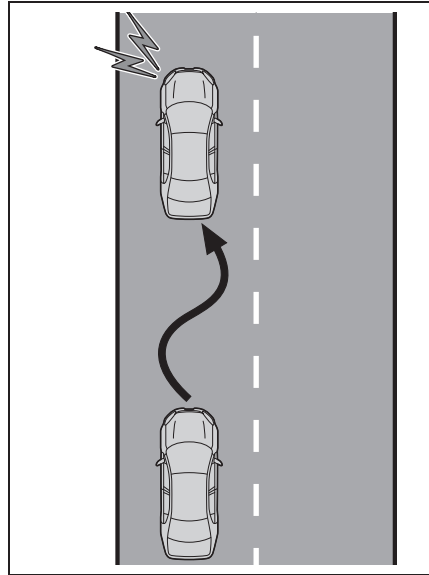

⚠ WARNING

■ Before using the LDA system

- Do not overly rely on the LDA system. The LDA system is a system which provides automated assistance in driving. However, as it is not a system which reduces the amount of attention necessary for safe driving. The driver is solely responsible for paying attention to their surroundings and operating the steering wheel as necessary to ensure safety. Also, the driver is responsible for taking adequate breaks when fatigued, such as when driving for a long time.
- Failure to perform appropriate driving operations and pay careful attention may lead to an accident.

■ Operating conditions of each function

- Lane departure alert/prevention function

This function is operable when all of the following conditions are met:

- The vehicle speed is approximately 50 km/h (30 mph) or more.

Operation may be possible when the vehicle speed is approximately 40 km/h (25 mph) or more if vehicles, motorcycles, bicycles, or pedestrians are detected near the lane.

- The system recognizes a lane or course*. (When recognized on only one side, the system will operate only for the recognized side.)
- The lane width is approximately 3 m (9.8 ft.) or more.
- The turn signal lever is not being operated. (Vehicles with BSM: Except when a vehicle is detected in the direction that the turn signal lever is operated.)
- The vehicle is not being driven around a sharp curve.
- The vehicle is not accelerating or decelerating more than a certain amount.
- The steering wheel is not being turned sufficiently to perform a lane change.

*: Boundary between the asphalt and grass, soil, etc., or structures, such as a curb, guardrail, etc.

● Break suggestion function

This function is operable when all of the following conditions are met:

- The vehicle speed is approximately 50 km/h (32 mph) or more.
- The lane width is approximately 3 m (9.8 ft.) or more.

■ Temporary cancellation of functions

When the operating conditions are no longer met, a function may be temporarily canceled. However, when the operation conditions are met again, operation of the function will automatically be restored. (→P.187)

■ Operation of the lane departure alert function/lane departure prevention function

- Depending on the vehicle speed, road conditions, lane departure angle, etc.,

operation of the lane departure prevention function may not be felt or the function may not operate.

- Depending on the conditions, the warning buzzer may operate even if vibration is selected through a customize setting.
- If a course* is not clear or straight, the lane departure alert function or lane departure prevention function may not operate.
- The lane departure alert function or lane departure prevention function may not operate if the system judges that the vehicle is intentionally being steered to avoid a pedestrian or parked vehicle.
- Vehicles with BSM: It may not be possible for the system to judge if there is danger of a collision with a vehicle in an adjacent lane.
- The steering assist operation of the lane departure prevention function can be overridden by the steering wheel operation of the driver.

*: Boundary between the asphalt and grass, soil, etc., or structures, such as a curb, guardrail, etc.

■ Hands off steering wheel warning operation

In the following situations, a message urging the driver to operate the steering wheel and an icon will be displayed and a buzzer will sound to warn the driver. When using the system, make sure to grip the steering wheel firmly, regardless of whether the warning is operating or not.

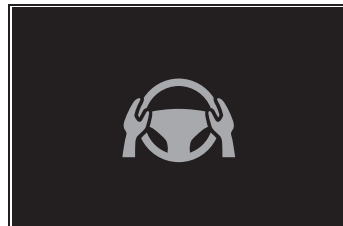

- When the system determines that the

driver is not securely holding the steering wheel, or the steering wheel is not being operated when the steering assist operation of the lane departure prevention function is operating

The length of time that the warning buzzer operates will become longer as the frequency of the steering assist operating increases. Even if the system judges that the steering wheel has been operated, the warning buzzer will sound for a certain amount of time.

■ Break suggestion function

If the vehicle is swaying, a message will be displayed and a warning buzzer will sound to urge the driver to take a break.

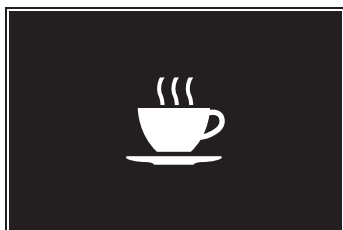

Depending on the condition of the vehicle and road surface, the break suggestion function may not operate.

Changing LDA settings

- The LDA system can be enabled/disabled through a customize setting. (→P.346)

- The settings of the LDA can be changed on the customize settings. (→P.352)

⚠ WARNING











■ Situations in which the system may not operate properly

In the following situations, the system may not operate properly and the vehicle may depart from its lane. Do not overly rely on these functions. The driver is solely responsible for paying attention to their surroundings and operating the steering wheel as necessary to ensure safety.

- When the boundary between the asphalt and grass, soil, etc., or structures, such as a curb, guardrail, etc. is not clear or straight
- When the vehicle is struck by a crosswind or the turbulence of other nearby vehicles
- Situations in which the lane may not be detected: →P.170
- Situations in which the sensors may not operate properly: →P.168
- Situations in which some or all of the functions of the system cannot operate: →P.170
- When it is necessary to disable the system: →P.165

Displays and system operation

The operating state of the lane departure alert function and steering assist operation of the lane departure prevention function are indicated.

Indicator	Lane display	Steering icon	Situation
 Orange Illuminated	Not illuminated	Not illuminated	System disabled
Not illuminated	 Gray	Not illuminated	Lane lines are not detected by the system
Not illuminated	 White	Not illuminated	Lane lines are detected by the system
 Orange Flashing	 Orange Flashing	Not illuminated	Lane departure alert function is operating for the side which the lane display is flashing
 Green	 Green	 Green	Lane departure prevention function is operating for the side which the lane display is illuminated
 Orange Flashing	 Orange Flashing	 Green	Lane departure alert function/lane departure prevention function is operating for the side which the lane display is flashing

Emergency Driving Stop System

The emergency driving stop system is a system which automatically decelerates and stops the vehicle within its lane if the driver becomes unable to continue driving the vehicle, such as if they have suffered a medical emergency, etc.

During LTA (Lane Tracing Assist) control, if the system does not detect driving operations, such as if the driver is not holding the steering wheel, and determines the driver is not responsive, the vehicle will be decelerated and stopped within its current lane to help avoid a collision or reduce the impact of a collision.



WARNING

■ For safe use

- Driving safely is solely the responsibility of the driver. Pay careful attention to the surrounding conditions in order to ensure safe driving. The emergency driving stop system is designed to provide support in an emergency where it is difficult for the driver to continue driving, such as if they have had a medical emergency. It is not designed to support driving while drowsy or in poor physical health, or inattentive driving.

- Although the emergency driving stop system is designed to decelerate the vehicle within its lane to help avoid or help reduce the impact of a collision if the system determines that it is difficult for the driver to continue driving, its effectiveness may change according to various conditions. Therefore, it may not always be able to achieve the same level of performance. Also, if the operating conditions are not met, this function will not operate.
- After the emergency driving stop system operates, if driving becomes possible again, immediately begin driving again or, if necessary, park the vehicle on the shoulder of the road and set a warning reflector and flare to warn other drivers of your stopped vehicle.
- After this system operates, passengers should attend to the driver as necessary and take appropriate hazard prevention measures, such as moving to a place where safety can be ensured, such as the shoulder of the road or behind a guard-rail.
- This system detects the condition of the driver through the operation of the steering wheel. This system may operate if the driver is aware but intentionally and continuously does not operate the vehicle. Also, the system may not operate if it cannot determine that the driver is not responsive, such as if they are leaning on the steering wheel.

Summary of the system

Operation of this system is separated into 4 control states. Through control state “warning phase 1” and “warning phase 2”, the system

determines if the driver is aware and responsive while outputting a warning and controlling the vehicle speed. If the system determines the driver is not responsive, it will operate in control state “deceleration stop phase” and “stop hold phase” and decelerate and stop the vehicle. It will then operate continuously in “stop hold phase”.

■ Operating conditions

This system operates when all of the following conditions are met:

- When the LTA is on
- When the vehicle speed is approximately 50 km/h (30 mph) or more

■ Operation cancelation conditions

In the following situations, system operation will be canceled:

- When LTA control has been canceled (the LTA switch has been pressed, etc.)
- When the dynamic radar cruise control has been canceled
- When driver operations are detected (the steering wheel is held, the brake pedal, accelerator pedal, parking brake, hazard light switch, or turn signal lever is operated)
- When the driving assist switch is pressed while in the stop and hold phase
- When the power switch has been turned from ON to off
- Situations in which some or all of the functions of the system cannot operate: →P.170

■ LTA control when operation is canceled

When emergency driving stop system operation is canceled, LTA control may also be canceled.

Warning phase 1

If driving operations are not detected after the hands off steering wheel warning operates, a buzzer will sound intermittently and a message will be displayed to warn the driver, and the system will judge if the driver is responsive or not. If driving operations, such as holding the steering wheel, are not performed within a certain amount of time, the system will enter warning phase 2.

Warning phase 2

After entering warning phase 2, a buzzer will sound in short intervals and a message will be displayed to warn the driver, and the vehicle will slowly decelerate. If driving operations, such as holding the steering wheel, are not performed within a certain amount of time, the system will determine that the driver is not responsive and enter the deceleration stop phase.

The audio system will be muted until the driver becomes responsive.

When the vehicle is decelerating, the brake lights may illuminate, depending on the road conditions, etc.

After the vehicle has decelerated a certain amount, the emergency flashers (hazard lights) will flash.

Deceleration stop phase

After the driver is judged as being not responsive, a buzzer will sound continuously and a message will be displayed to warn the driver, and the vehicle will slowly decelerate and stop. While the vehicle is decelerating, the emergency flashers (hazard lights) will flash to warn other drivers of the emergency.

Stop hold phase

After the vehicle is stopped, the parking brake will be applied automatically. After entering the stop and hold phase, the buzzer will continue sounding continuously, the emergency flashers (hazard lights) will flash to warn other drivers of the emergency, and the doors will unlock.

RSA (Road Sign Assist)

The RSA system detects specific road signs using the front camera and warns the driver via displays and buzzers.

WARNING

■ For safe use

- Driving safely is solely the responsibility of the driver. Pay careful attention to the surrounding conditions in order to ensure safe driving.
- Do not rely solely upon the RSA. The RSA assists the driver by providing road sign information, but it is not a replacement for the driver's own vision and awareness. Driving safely is solely the responsibility of the driver. Pay careful attention to the surrounding conditions in order to ensure safe driving.

■ Situations in which the RSA should not be used

- When it is necessary to disable the system: →P.165

■ Situations in which the system may not operate properly

- Situations in which the sensors may not operate properly: →P.168

Display Function

- When the front camera detects a sign, the sign will be displayed on the display.
- Multiple signs can be displayed.

Depending on the specifications of the vehicle, the number of displayed signs may be limited.

■ Operating conditions of sign display

Signs will be displayed when the following conditions are met:

- The system has detected a sign
In the following situations, a displayed sign may stop being displayed:
 - When a new sign has not been detected for a certain distance
 - When the system determines that the road being driven on has changed, such as after a left or right turn

■ Situations in which the display function may not operate properly

In the following situations, the RSA system may not operate properly and may not detect signs or may display the incorrect sign. However, this does not indicate a malfunction.

- When a sign is dirty, faded, tilted or bent
- When the contrast of an electronic sign is low
- When all or part of a sign is hidden by a tree, utility pole, etc.
- When a sign is detected by the front camera for a short amount of time
- When the driving state (turning, changing lanes, etc.) is judged incorrectly
- When a sign is immediately after a freeway junction or in an adjacent lane just before merging
- When stickers are attached to the rear of a preceding vehicle
- When a sign similar to a system compatible sign is detected as a system compatible sign
- When a speed limit sign for a frontage road is within detection range of the front camera
- When driving around a roundabout
- When a sign intended for trucks, etc. is detected

- When the navigation system map data is out of date
- When the navigation system cannot be used

In this case, the speed limit signs displayed on the multi-information display and navigation system display may differ.

Notification function

In the following situations, the RSA system will output a warning to notify the driver.

- If the vehicle speed exceeds the speed warning threshold of the speed limit sign displayed on the display, the sign display will be emphasized and a buzzer will sound.

■ Operating conditions of the notification functions

- Excess speed notification function

This function will operate when the following condition is met:

- A speed limit road sign is recognized by the system.

Types of road signs supported

- The following types of road signs can be displayed.

However, non-standard or recently introduced traffic signs may not be displayed.

- ▶ Speed limit road signs*

	Speed limit
---	-------------

*: No speed limit information  is displayed when a speed limit sign is not available.

▶ Speed limit with supplemental mark*

	Rain
	Time

*: Displayed simultaneously with a speed limit sign.

- Depending on the specifications of the vehicle, signs may be displayed overlapping.

	Duplicate display example
---	---------------------------

Changing RSA settings

The following settings of the RSA can be changed through customize settings. (→P.346)

Dynamic radar cruise control

This dynamic radar cruise control detects the presence of vehicles ahead, determines the current vehicle-to-vehicle distance, and operates to maintain a suitable distance from the vehicle ahead. The desired vehicle-to-vehicle distance can be set by operating the vehicle-to-vehicle distance switch.

Use the dynamic radar cruise control only on highways and expressways.

WARNING

■ For safe use

- Driving safely is solely the responsibility of the driver. Do not overly rely on this system, and pay careful attention to the surrounding conditions in order to ensure safe driving.
- The dynamic radar cruise control provides driving assistance to reduce the driver's burden. However, there are limitations to the assistance provided.

Read the following items carefully. Do not overly rely on this system and always drive carefully.

Conditions under which the system may not operate correctly: →P.201

- Set the speed appropriately according to the speed limit, traffic flow, road conditions, weather conditions, etc. The driver is responsible for confirming the set speed.



WARNING

- Even if the system is operating correctly, the condition of a preceding vehicle as recognized by the driver and detected by the system may differ. Therefore, it is necessary for the driver to pay attention, assess risks, and ensure safety. Over-reliance on this system to drive the vehicle safely may lead to an accident resulting in death or serious injury.

■ Precautions for the driving assist systems

Observe the following precautions, as there are limitations to the assistance provided by the system. Over-reliance on this system may lead to an accident resulting in death or serious injury.

- Details of support provided for the driver's vision

The dynamic radar cruise control is only intended to help the driver in determining the distance between the driver's own vehicle and a designated preceding vehicle. It is not a system which allows for careless or inattentive driving, and is not a system which assists in poor visibility conditions.

The driver must pay attention to their surroundings, even when the vehicle stops.

- Details of support provided for the driver's judgement

The dynamic radar cruise control determines whether the distance between the driver's own vehicle and a designated preceding vehicle is within a set range. It is not capable of making any other type of judgement. Therefore, it is absolutely necessary for the driver to remain vigilant and to determine whether or not there is a possibility of danger.

- Details of support provided for the driver's operation

The dynamic radar cruise control does not include functions which will prevent or avoid collisions with vehicles ahead of your vehicle. Therefore, if there is ever any possibility of danger, the driver must take immediate and direct control of the vehicle and act appropriately in order to ensure safety.

■ Situations in which the dynamic radar cruise control should not be used

Do not use the dynamic radar cruise control in the following situations. As the system will not be able to provide appropriate control, using it may lead to an accident resulting in death or serious injury.

- Roads where there are pedestrians, cyclists, etc.
- When driving on a highway or expressway entrance or exit
- When the approach warning sounds frequently
- Situations in which the sensors may not operate properly: →P.165
- Situations in which the lane may not be detected: →P.170

Basic functions

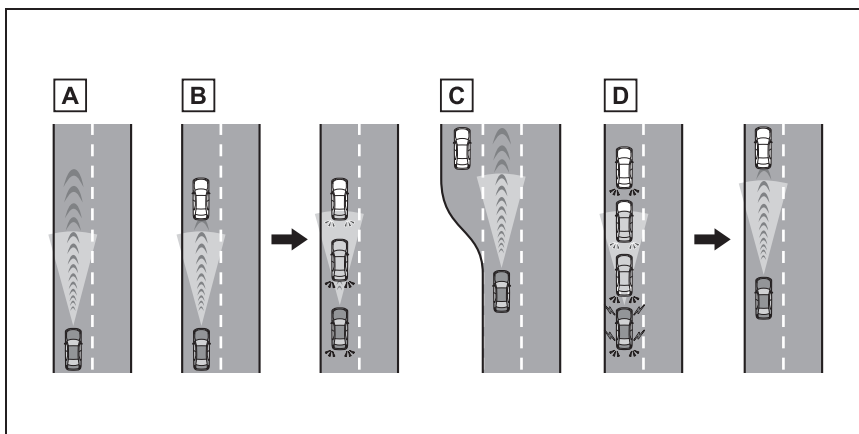
**A** Constant speed cruising:

When there are no vehicles ahead

The vehicle drives at the speed set by the driver.

If the set vehicle speed is exceeded while driving down a hill, the set vehicle speed display will blink and a buzzer will sound.

B Deceleration and follow-up cruising

When a preceding vehicle driving slower than the set vehicle speed is detected

When a vehicle is detected driving ahead of your vehicle, the vehicle automatically decelerates and if a greater reduction in vehicle speed is necessary, the brakes are applied (the stop lights will come on at this time). The vehicle is controlled to maintain the vehicle-to-vehicle distance set by the driver, in accordance with changes in the speed of the preceding vehicle. If vehicle deceleration is not sufficient and the vehicle approaches the vehicle ahead, the approach warning will sound.

C Acceleration

When there are no longer any preceding vehicles driving slower than the set vehicle speed

The vehicle accelerates until the set vehicle speed is reached and then resumes constant speed cruising.

D Starting off:

If a preceding vehicle stops, the vehicle will also stop (controlled stop). After the preceding vehicle starts off, pressing the "RES" switch or depressing the accelerator pedal will resume follow-up cruising (start off operation). If a start off operation is not performed, the controlled stop

will continue.

System Components

■ Meter display

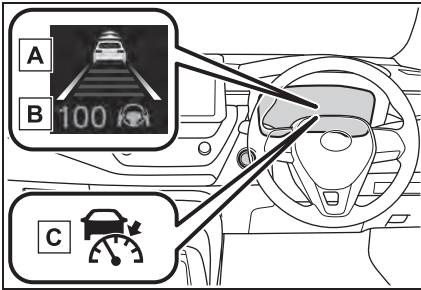

A Multi-information display

B Set vehicle speed

C Indicators

■ Switches

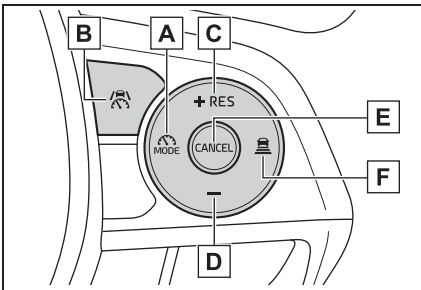

A Driving assist mode select switch

B Driving assist switch

C “+” switch / “RES” switch

D “-” switch

E Cancel switch

F Vehicle-to-vehicle distance switch

Using the dynamic radar cruise control

Setting the vehicle speed

- 1 Press the driving assist mode select switch to select dynamic radar cruise control.

The dynamic radar cruise control indicator will illuminate.

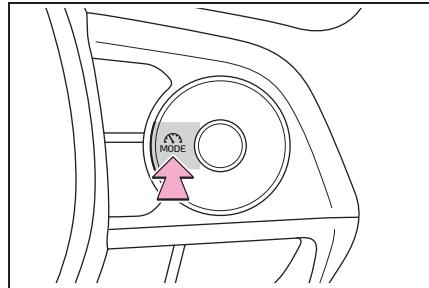

- 2 Using the accelerator pedal, accelerate or decelerate to the desired vehicle speed (approximately 30 km/h [20 mph] or more), and press the driving assist switch to set the set vehicle speed.

The set vehicle speed will be displayed on the multi-information display.

The vehicle speed at the moment the switch is released will be the set vehicle speed.

speed.

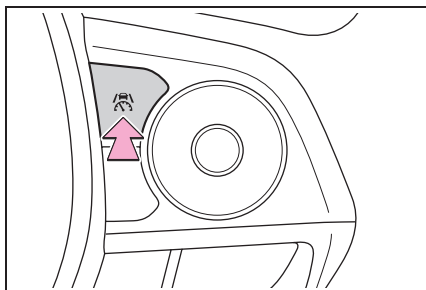

Adjusting the set vehicle speed

- Adjusting the set vehicle speed using the switches

To change the set vehicle speed, press the “+” or “-” switch until the desired speed is displayed.

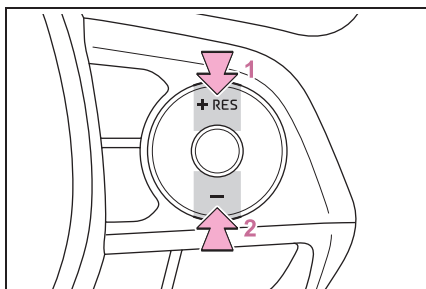

- 1 Increase set vehicle speed
- 2 Decrease set vehicle speed

Short press adjustment: Press the switch

Long press adjustment: Press and hold the switch until the desired set vehicle speed is reached.

The set vehicle speed will increase or decrease as follows:

Short press adjustment: By 1 km/h (0.6 mph) or 1 mph (1.6 km/h) each time the switch is pressed

Long press adjustment: Increases or decreases in 5 km/h (3.1 mph) or 5 mph (8 km/h) increments continuously while the switch is pressed and held

The set vehicle speed adjustment increment can be changed through a customize setting.

- Increasing the set vehicle speed using the accelerator pedal

- 1 Depress the accelerator pedal to accelerate the vehicle to the desired vehicle speed.
- 2 Press the “+” switch.

Canceling/resuming control

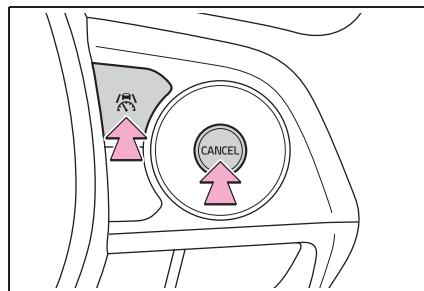

- 1 Press the cancel switch or driving assist switch to cancel control.

Control will also be canceled if the brake pedal is depressed.

(If the vehicle has been stopped by system control, depressing the brake pedal will not cancel control.)

- 2 Press the “RES” switch to resume control.

Changing the vehicle-to-vehicle distance

Each time the switch is pressed, the vehicle-to-vehicle distance setting will change as follows:

If a preceding vehicle is detected, the preceding vehicle mark will be displayed.

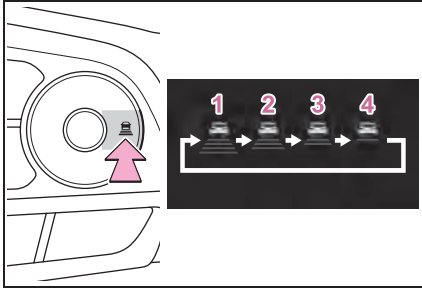

Illustration Number	Vehicle-to-vehicle distance	Approximate Distance (Vehicle Speed: 100 km/h [60 mph])
1	Extra long	Approximately 70 m (230 ft.)
2	Long	Approximately 60 m (200 ft.)
3	Medium	Approximately 45 m (145 ft.)
4	Short	Approximately 30 m (100 ft.)

The actual vehicle-to-vehicle distance varies in accordance with the vehicle speed. Also, when the vehicle is stopped by system control, it will be stopped at a certain distance from the preceding vehicle, depending on the situation, regardless of the setting.

Operating conditions

- The shift lever is in D.
- The desired set speed can be set when the vehicle speed is approximately 30 km/h (20 mph) or more.
- If the vehicle speed is set while driving at below approximately 30 km/h (20 mph), the set vehicle speed will be approximately 30 km/h (20 mph).
- If the vehicle speed is set while driving at a speed that exceeds the system's upper limit, the set vehicle speed will be the system's upper limit.

Accelerating after setting the vehicle speed

As with normal driving, acceleration can

be performed by depressing the accelerator pedal. After accelerating, the vehicle will return to the set vehicle speed. However, while in vehicle-to-vehicle distance control mode, the vehicle speed may decrease to below the set vehicle speed in order to maintain the distance from the preceding vehicle.

When the vehicle is stopped by system control during follow-up cruising

- When the "+RES" switch is pressed while the vehicle is stopped by system control, if the preceding vehicle starts off within approximately 3 seconds, follow-up cruising will resume.
- If the preceding vehicle starts off

within approximately 3 seconds of the vehicle being stopped by system control, follow-up cruising will resume.

■ Automatic cancellation of vehicle-to-vehicle distance control mode

In the following situations, vehicle-to-vehicle distance control mode will be canceled automatically:

- When the brake control or output restriction control of a driving support system operates
(For example: Pre-Collision System, drive-start control)
- When the parking brake has been operated
- When the vehicle is stopped by system control on a steep incline
- When any of the following are detected while the vehicle is stopped by system control:
 - The driver's seat belt is unfastened
 - The driver's door is opened
 - Approximately 3 minutes have elapsed since the vehicle was stopped

The parking brake may be activated automatically.

- Situations in which some or all of the functions of the system cannot operate: →P.170

■ Dynamic radar cruise control system warning messages and buzzers

For safe use: →P.165

■ Preceding vehicles that the sensor may not detect correctly

In the following situations, depending on the conditions, if the system cannot provide sufficient deceleration or acceleration is necessary, operate the brake pedal or accelerator pedal.

As the sensor may not be able to correctly detect these types of vehicles, the approach warning (→P.201) may not operate.

- When a vehicle cuts in front of your

vehicle or changes lanes away from your vehicle extremely slowly or quickly

- When changing lanes
- When a preceding vehicle is driving at a low speed
- When a vehicle is stopped in the same lane as the vehicle
- When a motorcycle is traveling in the same lane as the vehicle

■ Conditions under which the system may not operate correctly

In the following situations, operate the brake pedal (or accelerator pedal, depending on the situation) as necessary.

As the sensor may not be able to correctly detect a vehicle, the system may not operate properly.

- When a preceding vehicle brakes suddenly
- When changing lanes at low speeds, such as in a traffic jam

Approach warning

In situations where the vehicle approaches a preceding vehicle and the system cannot provide sufficient deceleration, such as if a vehicle cuts in front of the vehicle, a warning display will flash and a buzzer will sound to alert the driver. Depress the brake pedal to ensure appropriate vehicle-to-vehicle distance.

■ Warnings may not occur when

In the following situations, the warning may not operate even though the vehicle-to-vehicle distance is short.

- When the preceding vehicle is

traveling at the same speed or faster than your vehicle

- When the preceding vehicle is traveling at an extremely low speed
- Immediately after the vehicle speed has been set
- When the accelerator pedal is depressed

Curve speed reduction function

When a curve is detected, the vehicle speed will begin being reduced. When the curve ends, the vehicle speed reduction will end.

Depending on the situation, the vehicle speed will then return to the set vehicle speed.

In situations where vehicle-to-vehicle distance control needs to operate, such as when a preceding vehicle cuts in front of your vehicle, the curve speed reduction function will be canceled.



Situations in which the curve speed reduction function may not operate

In situations such as the following, the curve speed reduction function may not operate:

- When the vehicle is being driven around a gentle curve
- When the accelerator pedal is being depressed
- When the vehicle is being driven around an extremely short curve

Support for lane change

If your vehicle is being driven at approximately 80 km/h (50 mph) or more and a lane change to the passing lane is performed, when the turn signal lever is operated and the lane is changed, the vehicle will accelerate up to the set speed to assist in overtaking.

The system's recognition of which lane is the passing lane may be based solely on the location of the steering wheel in the vehicle (left-hand drive/right-hand drive). If the vehicle is driven in a location where the passing lane is on the opposite side of that where the vehicle was originally sold, the vehicle may accelerate when the turn signal lever is operated away from the passing lane. (e.g. The vehicle was manufactured for a right-hand traffic location, but is being driven in a left-hand traffic location. The vehicle may accelerate when the turn signal lever is operated to the right.)

If your vehicle is being driven at approximately 80 km/h (50 mph) or more and the lane is changed to that with a vehicle traveling slower than your vehicle, when the turn signal lever is operated the vehicle will gradually decelerate to assist in changing lanes.

Dynamic Radar Cruise Control with Road Sign Assist

When RSA function is enabled and the dynamic radar cruise control system is operating, if a speed limit sign is detected, the detected speed limit will be displayed with an up/down arrow. The set speed can be increased/reduced to the detected speed limit by pressing and holding the “+” switch or “-” switch.

When the set speed is lower than the detected speed limit

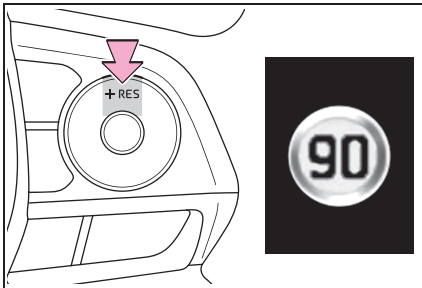

Press and hold the “+” switch.

When the set speed is higher than the detected speed limit

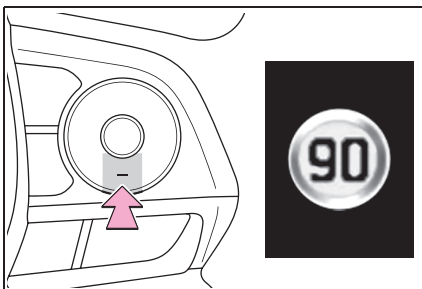

Press and hold the “-” switch.

■ The dynamic radar cruise control with road sign assist may not operate properly when

As the dynamic radar cruise control with road sign assist may not operate properly in situations where the RSA may not operate or cannot detect signs correctly (→P.194), when using this function, make sure to confirm the actual speed limit.

In the following situations, the set speed may not change to the detected speed limit by pressing and holding the “+” switch or “-” switch:

- When speed limit information is not available
- When the detected speed limit is the same as the set speed
- When the detected speed limit is outside of the speed range which the dynamic radar cruise control system can operate

Changing Dynamic radar cruise control settings

- The settings of Dynamic radar cruise control can be changed through customize settings. (→P.346)

Cruise control

The vehicle can be driven at a set speed even if the accelerator pedal is not depressed.

Use the cruise control only on highways and expressways.



WARNING

■ For safe use

● Driving safely is solely the responsibility of the driver. Therefore, do not overly rely on this system. The driver is solely responsible for paying attention to the vehicle's surroundings and driving safely.

● Set the speed appropriately according to the speed limit, traffic flow, road conditions, weather conditions, etc. The driver is responsible for confirming the set speed.

■ Situations in which cruise control should not be used

Do not use the cruise control in the following situations. As the system will not be able to provide appropriate control, using it may lead to an accident resulting in death or serious injury.

- On roads with sharp bends
- On winding roads
- On slippery roads, such as those covered with rain, ice or snow
- On steep downhills, or where there are sudden changes between sharp up and down gradients

Vehicle speed may exceed the set speed when driving down a steep hill.

● When it is necessary to disable the system: →P.165

System Components

■ Meter display

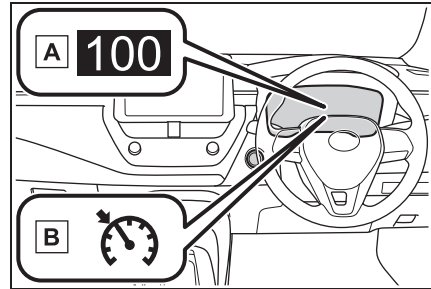

A Set vehicle speed

B Cruise control indicator

■ Switches

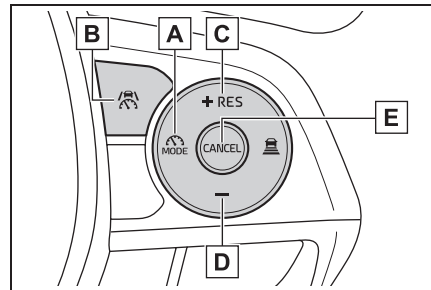

A Driving assist mode select switch

B Driving assist switch

C "+" switch / "RES" switch

D "-" switch

E Cancel switch

Using the cruise control

Setting the vehicle speed

- 1 Press the driving assist mode select switch to select cruise control.

The cruise control indicator will illuminate.

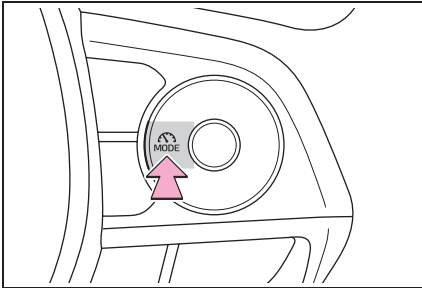

- 2 Using the accelerator pedal, accelerate to the desired vehicle speed (approximately 30 km/h [20 mph] or more), and press the driving assist switch to set the set vehicle speed.

The vehicle speed at the moment the switch is released will be the set vehicle speed.

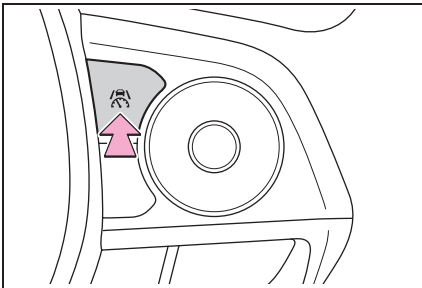

Adjusting the set vehicle speed

- **Adjusting the set vehicle speed using the switches**

To change the set vehicle speed, press the “+” or “-” switch until the desired speed is displayed.

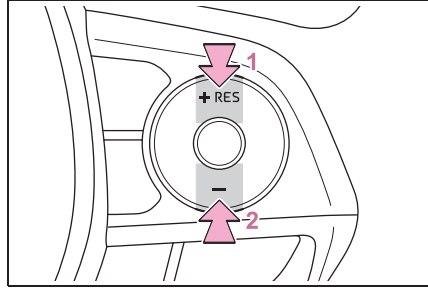

- 1 Increase set vehicle speed
- 2 Decrease set vehicle speed

The set vehicle speed will increase or decrease as follows:

Fine adjustment: By 1 km/h (0.6 mph) or 1 mph (1.6 km/h) each time the switch is pressed

Large adjustment: Increases continuously while the switch is pressed and held

- **Increasing the set vehicle speed using the accelerator pedal**

- 1 Depress the accelerator pedal to accelerate the vehicle to the desired vehicle speed.
- 2 Press the “+” switch.

Canceling/resuming control

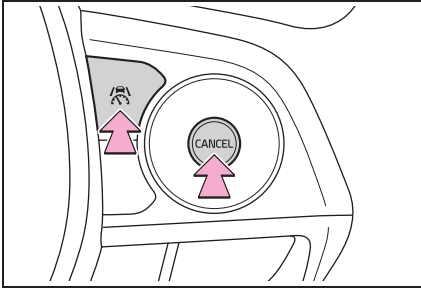

- 1 Press the cancel switch or driving assist switch to cancel control.

Control will also be canceled if the brake pedal is depressed.

- 2 Press the "RES" switch to resume control.

Automatic cancellation of the cruise control

In the following situations, the cruise control will be canceled automatically:

- When the vehicle speed drops approximately 16 km/h (10 mph) or more below the set vehicle speed
- When the vehicle speed drops below approximately 30 km/h (20 mph)
- When the brake control or output restriction control of a driving support system operates (For example: PCS, drive-start control)
- When the parking brake has been operated
- Situations in which some or all of the functions of the system cannot operate: →P.170

BSM (Blind Spot Monitor)*

*: If equipped

The Blind Spot Monitor is a system that uses rear side radar sensors installed on the inner side of the rear bumper on the left and right side to assist the driver in confirming safety when changing lanes.

⚠ WARNING

■ Cautions regarding the use of the system

- The driver is solely responsible for safe driving. Always drive safely, taking care to observe your surroundings.
- The Blind Spot Monitor is a supplementary function which alerts the driver that a vehicle is in a blind spot of the outside rear view mirrors or is approaching rapidly from behind into a blind spot. Do not overly rely on the Blind Spot Monitor. As the function cannot judge if it is safe to change lanes, over reliance could lead to an accident resulting in death or serious injury. As the system may not function correctly under certain conditions, the driver's own visual confirmation of safety is necessary.

System components

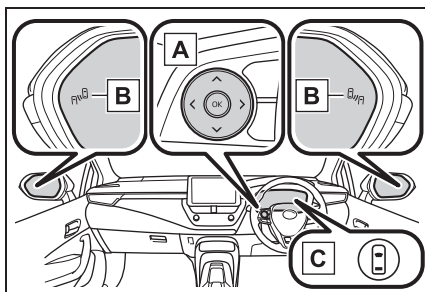

A Meter control switches

Turning the Blind Spot Monitor on/off.

B Outside rear view mirror indicators

When a vehicle is detected in a blind spot of the outside rear view mirrors or approaching rapidly from behind into a blind spot, the outside rear view mirror indicator on the detected side will illuminate. If the turn signal lever is operated toward the detected side, the outside rear view mirror indicator flashes.

C Driving assist information indicator

Illuminates when the Blind Spot Monitor is turned off. At this time, "Blind Spot Monitor OFF" will be displayed on the multi-information display.

Outside rear view mirror indicator visibility

In strong sunlight, the outside rear view mirror indicator may be difficult to see.

Customization

Some functions can be customized.
(→P.346)

WARNING

To ensure the system can operate properly

Blind Spot Monitor sensors are installed behind the left and right sides of the rear bumper respectively. Observe the following to ensure the Blind Spot Monitor can operate correctly.

- Keep the sensors and the surrounding areas on the rear bumper clean at all times.

If a sensor or its surrounding area on the rear bumper is dirty or covered with snow, the Blind Spot Monitor may not operate and a warning message will be displayed. In this situation, clear off the dirt or snow and drive the vehicle with the operation conditions of the BSM function (→P.209) satisfied for approximately 10 minutes. If the warning message does not disappear, have the vehicle inspected by your Toyota dealer.

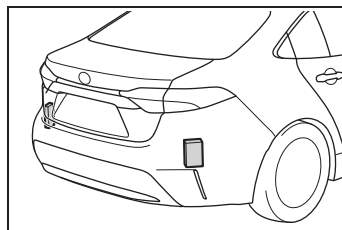

- Do not attach accessories, stickers (including transparent stickers), aluminum tape, etc. to a sensor or its surrounding area on the rear bumper.

**WARNING**

- Do not subject a sensor or its surrounding area on the rear bumper to a strong impact.

If a sensor is moved even slightly off position, the system may malfunction and vehicles may not be detected correctly.

In the following situations, have your vehicle inspected by your Toyota dealer.

- A sensor or its surrounding area is subject to a strong impact.
- If the surrounding area of a sensor is scratched or dented, or part of them has become disconnected.
- Do not disassemble the sensor.
- Do not modify the sensor or surrounding area on the rear bumper.
- If a sensor or the rear bumper needs to be removed/installed or replaced, contact your Toyota dealer.

- Do not paint the rear bumper any color other than an official Toyota color.

Turning the Blind Spot Monitor on/off

The Blind Spot Monitor can be enabled/disabled on  of the multi-information display. (→P.346)

When the Blind Spot Monitor function is off, the driving assist information indicator (→P.70) will illuminate. At this time, “Blind Spot Monitor OFF” will be displayed on the multi-information display.

Each time the power switch is turned to ON, the Blind Spot Monitor is enabled.

Blind Spot Monitor operation

■ Objects that can be detected while driving

The Blind Spot Monitor uses rear side radar sensors to detect the following vehicles traveling in adjacent lanes and advises the driver of the presence of such vehicles via the indicators on the outside rear view mirrors.

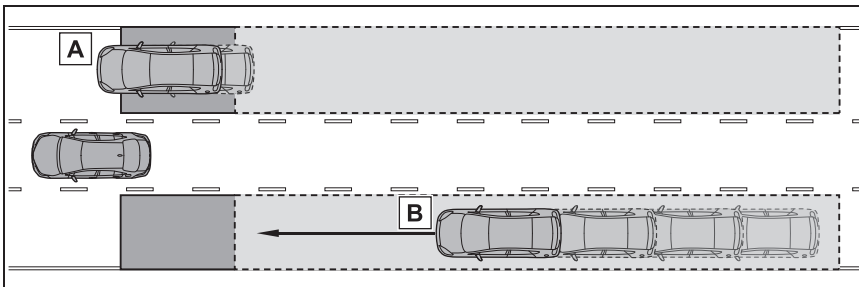

- A** Vehicles that are traveling in areas that are not visible using the outside rear view mirrors (the blind spots)
- B** Vehicles that are approaching rapidly from behind in areas that are not visible using the outside rear view mirrors (the blind spots)

■ Detection range while driving

The areas that vehicles can be detected in are outlined below.

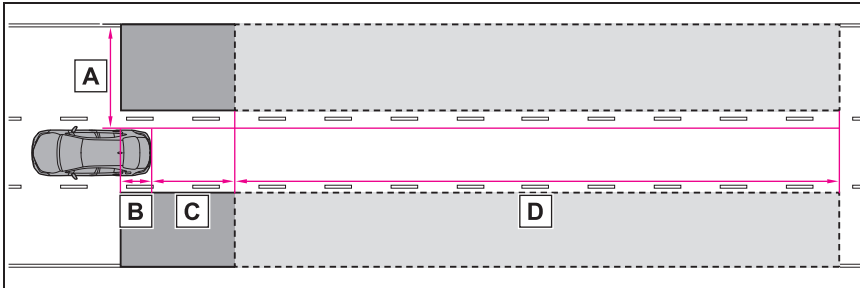

The range of each detection area is:

- A** Approximately 0.5 m (1.6 ft.) to 3.5 m (11.5 ft.) from either side of the vehicle^{*1}
- B** Approximately 1 m (3.3 ft.) forward of the rear bumper
- C** Approximately 3 m (9.8 ft.) from the rear bumper
- D** Approximately 3 m (9.8 ft.) to 60 m (197 ft.) from the rear bumper^{*2}

^{*1}: The area between the side of the vehicle and 0.5 m (1.6 ft.) from the side of the vehicle cannot be detected.

^{*2}: The greater the difference in speed between your vehicle and the detected vehicle is, the farther away the vehicle will be detected, causing the outside rear view mirror indicator to illuminate or flash.

■ The Blind Spot Monitor is operational when

The Blind Spot Monitor is operational when all of the following conditions are met:

- The power switch is in ON.
- The Blind Spot Monitor is on.
- The shift lever is in a position other than R.
- The vehicle speed is approximately 10km/h (7 mph) or more.

■ The Blind Spot Monitor will detect a vehicle when

The Blind Spot Monitor will detect a vehicle present in the detection area in the following situations:

- A vehicle in an adjacent lane overtakes your vehicle.
- You overtake a vehicle in an adjacent lane slowly.
- Another vehicle enters the detection area when it changes lanes.

■ Situations in which the blind spot monitor cannot detect vehicles.

The blind spot monitor cannot detect the following vehicles and other objects:

- Small motorcycles, bicycles, pedestrians, etc.
- Vehicles traveling in the opposite direction
- Guardrails, walls, signs, parked vehicles and similar stationary objects*
- Following vehicles that are in the same lane
- Vehicles traveling 2 lanes away from your vehicle
- Vehicles which are being overtaken rapidly by your vehicle

*: Depending on the conditions, detection of a vehicle and/or object may occur.

■ Conditions under which the System may not function correctly

- The Blind Spot Monitor may not detect vehicles correctly in the following situations:
 - When the sensor is misaligned due to a strong impact to the sensor or its surrounding area
 - When mud, snow, ice, a sticker, etc. is covering the sensor or surrounding area on the rear bumper
 - When driving on a road surface that is wet with standing water during bad weather, such as heavy rain, snow, or fog
 - When multiple vehicles are approaching with only a small gap between each vehicle
 - When the distance between your vehicle and a following vehicle is short
 - When there is a significant difference in speed between your vehicle and the vehicle that enters the detection area
 - When the difference in speed between your vehicle and another vehicle is changing
 - When a vehicle enters a detection area traveling at about the same

speed as your vehicle

- As your vehicle starts from a stop, a vehicle remains in the detection area
- When driving up and down consecutive steep inclines, such as hills, dips in the road, etc.
- When driving on roads with sharp bends, consecutive curves, or uneven surfaces
- When vehicle lanes are wide, or when driving on the edge of a lane, and the vehicle in an adjacent lane is far away from your vehicle
- When an accessory (such as a bicycle carrier) is installed to the rear of the vehicle
- When there is a significant difference in height between your vehicle and the vehicle that enters the detection area
- Immediately after the Blind Spot Monitor is turned on
- When towing with the vehicle
- Instances of the Blind Spot Monitor unnecessarily detecting a vehicle and/or object may increase in the following situations:
 - When the sensor is misaligned due to a strong impact to the sensor or its surrounding area
 - When the distance between your vehicle and a guardrail, wall, etc. that enters the detection area is short
 - When driving up and down consecutive steep inclines, such as hills, dips in the road, etc.
 - When vehicle lanes are narrow, or when driving on the edge of a lane, and a vehicle traveling in a lane other than the adjacent lanes enters the detection area
 - When driving on roads with sharp bends, consecutive curves, or uneven surfaces
 - When the tires are slipping or spinning
 - When the distance between your vehicle and a following vehicle is short
 - When an accessory (such as a bicycle carrier) is installed to the rear of the vehicle
 - When towing with the vehicle

RCTA (Rear Cross Traffic Alert) function*

*: If equipped

The RCTA function uses the BSM rear side radar sensors installed behind the rear bumper. This function is intended to assist the driver in checking areas that are not easily visible when backing up.



WARNING

■ Cautions regarding the use of the system

The driver is solely responsible for safe driving. Always drive safely, taking care to observe your surroundings. The RCTA function is only a supplementary function which alerts the driver that a vehicle is approaching from the right or left at the rear of the vehicle. As the RCTA function may not function correctly under certain conditions, the driver's own visual confirmation of safety is necessary. Over reliance on this function may lead to an accident resulting death or serious injury.

System components

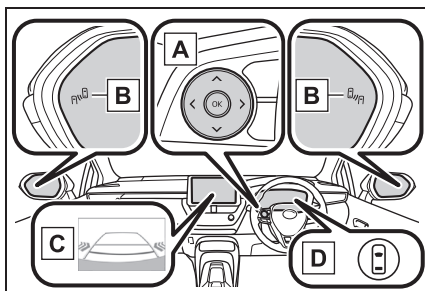

A Meter control switches

Turning the RCTA function on/off.

When the RCTA function is disabled, the RCTA OFF indicator illuminates.

B Outside rear view mirror indicators

If a vehicle is detected as approaching from the left or right behind the vehicle, both outside rear view mirror indicators will blink and a buzzer will sound.

C Audio system screen

If a vehicle approaching from the right or left at the rear of the vehicle is detected, the RCTA icon (→P.212) for the detected side will be displayed on the audio system screen. This illustration shows an example of a vehicle approaching from both sides of the vehicle.

D Driving assist information indicator

When the RCTA is off, "Rear Cross Traffic Alert OFF" will be displayed on the multi-information display.

Turning the RCTA function on/off

The RCTA can be enabled/disabled on  of the multi-information display. (→P.346)

When the RCTA function is off, the driving assist information indicator (→P.70) will illuminate. At this time, "Rear Cross Traffic Alert OFF" will be displayed on the multi-information display.

■ Outside rear view mirror indicator visibility

In strong sunlight, the outside rear view mirror indicator may be difficult to see.

■ Hearing the RCTA buzzer

The RCTA buzzer may be difficult to hear over loud noises, such as if the audio system volume is high.

■ Rear side radar sensors

→P.207

RCTA function

■ Operation of the RCTA function

The RCTA function uses rear side radar sensors to detect vehicles approaching from the right or left at the rear of the vehicle and alerts the driver of the presence of such vehicles by flashing the outside rear view mirror indicators and sounding a buzzer.

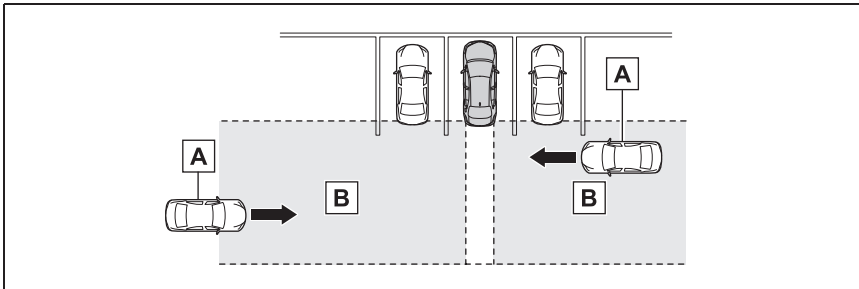

A Approaching vehicles

B Detection areas of approaching vehicles

■ RCTA icon display

When a vehicle approaching from the right or left at the rear of the vehicle is detected, the following will be displayed on the audio system screen.

- Example: Vehicles are approaching from both sides of the vehicle

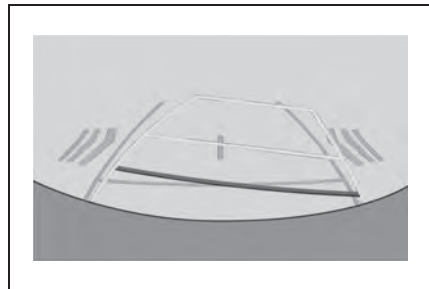

■ RCTA function detection areas

The areas that vehicles can be detected in are outlined below.

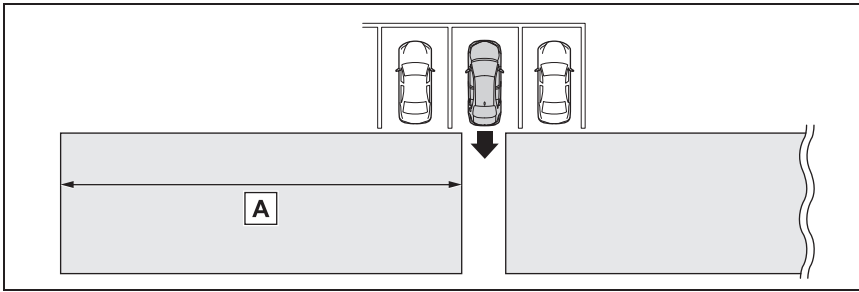

The buzzer can alert the driver of faster vehicles approaching from farther away.

Example:

Approaching vehicle speed	A Approximate alert distance
56 km/h (34 mph) (fast)	40 m (131 ft.)
8 km/h (5 mph) (slow)	5.5 m (18 ft.)

■ The RCTA function is operational when

The RCTA function operates when all of the following conditions are met:

- The power switch is in ON.
- The RCTA function is on.
- The shift lever is in R.
- The vehicle speed is less than approximately 15 km/h (9 mph).
- The approaching vehicle speed is between approximately 8 km/h (5 mph) and 56 km/h (34 mph).

■ Setting the buzzer volume

The buzzer volume can be adjusted on the multi-information display.

The volume of the RCTA buzzer can be adjusted on  of the multi-information display. (→P.346)

■ Conditions under which the system will not detect a vehicle

The RCTA function is not designed to detect the following types of vehicles and/or objects:

- Vehicles approaching from directly behind

- Vehicles backing up in a parking space next to your vehicle
- Vehicles that the sensors cannot detect due to obstructions

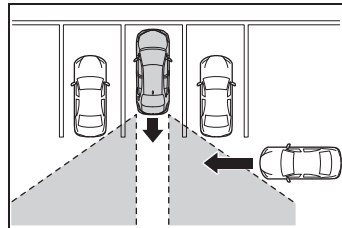

- Guardrails, walls, signs, parked vehicles and similar stationary objects*
- Small motorcycles, bicycles, pedestrians, etc.*
- Vehicles moving away from your vehicle
- Vehicles approaching from the parking spaces next to your vehicle*
- The distance between the sensor and approaching vehicle gets too close

*: Depending on the conditions, detection of a vehicle and/or object may occur.

■ Situations in which the system may not operate properly

The RCTA function may not detect vehicles correctly in the following situations:

- When the sensor is misaligned due to a strong impact to the sensor or its surrounding area
- When mud, snow, ice, a sticker, etc., is covering the sensor or surrounding area on the position above the rear bumper
- When driving on a road surface that is wet with standing water during bad weather, such as heavy rain, snow, or fog
- When multiple vehicles are approaching with only a small gap between each vehicle
- When a vehicle is approaching at high speed
- When equipment that may obstruct a sensor is installed, such as a towing eyelet, bumper protector (an additional trim strip, etc.), bicycle carrier, or snow plow
- When backing up on a slope with a sharp change in grade

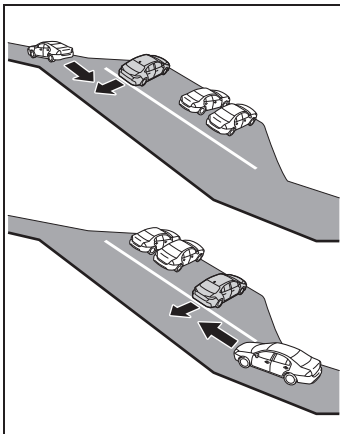

- When backing out of a sharp angle parking spot

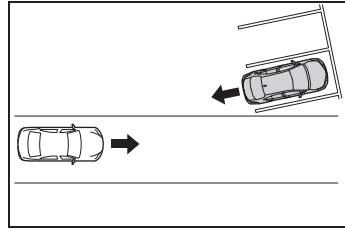

- Immediately after the RCTA function is turned on
- Immediately after the hybrid system is started with the RCTA function on
- When the sensors cannot detect a vehicle due to obstructions
- When towing a trailer
- When there is a significant difference in height between your vehicle and the vehicle that enters the detection area
- When a sensor or the area around a sensor is extremely hot or cold
- If the suspension has been modified or tires of a size other than specified are installed
- If the front of the vehicle is raised or lowered due to the carried load
- When turning while backing up

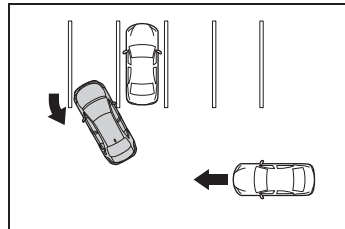

- When a vehicle turns into the detection area

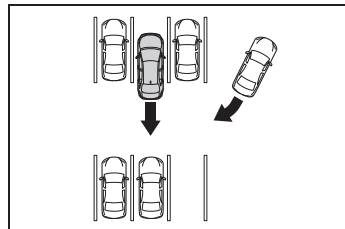

■ **Situations in which the system may operate even if there is no possibility of a collision**

Instances of the RCTA function unnecessary detecting a vehicle and/or object may increase in the following situations:

- When the parking space faces a street and vehicles are being driven on the street

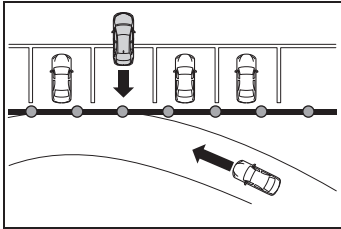

- When the distance between your vehicle and metal objects, such as a guardrail, wall, sign, or parked vehicle, which may reflect electrical waves toward the rear of the vehicle, is short

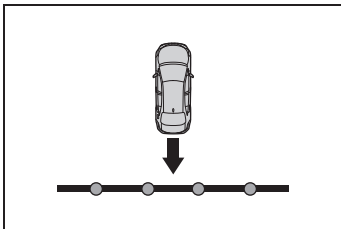

- When equipment that may obstruct a sensor is installed, such as a towing eyelet, bumper protector (an additional trim strip, etc.), bicycle carrier, or snow plow
- When a vehicle passes by the side of your vehicle

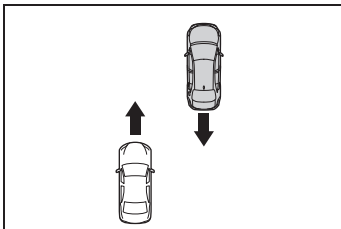

- When a detected vehicle turns while approaching the vehicle

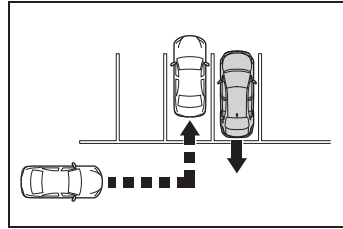

- When there are spinning objects near your vehicle such as the fan of an air conditioning unit
- When water is splashed or sprayed toward the rear bumper, such as from a sprinkler
- Moving objects (flags, exhaust fumes, large rain droplets or snowflakes, rain water on the road surface, etc.)
- When the distance between your vehicle and a guardrail, wall, etc., that enters the detection area is short
- Gratings and gutters
- When a sensor or the area around a sensor is extremely hot or cold
- If the suspension has been modified or tires of a size other than specified are installed
- If the front of the vehicle is raised or lowered due to the carried load

Safe Exit Assist*

*: If equipped

The safe exit assist is a system that uses rear side radar sensors installed on the inner side of the rear bumper to help occupants judge if an approaching vehicle or bicycle may collide with a door when opening it or cancel opening of the door, to reduce the possibility of a collision.



WARNING

■ Cautions regarding the use of the system

- The driver is solely responsible for safe driving. Always drive safely, taking care to observe your surroundings.
- The safe exit assist is a supplementary system that, when the vehicle is stopped, informs occupants of the existence of approaching vehicles and bicycles. As this system alone cannot be used to judge safety, over-reliance on this system may lead to an accident resulting in death or serious injury.

In certain situations, this system may not function to its fullest extent. Therefore it is necessary for the occupants to visually check for safety directly and using the mirrors.

System components

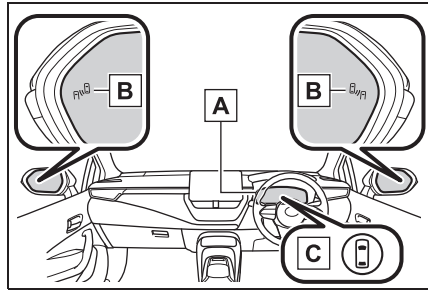

A Multi-information display

Turning the safe exit assist on/off.

When the system determines that the possibility of a collision with a door is high, the target door is displayed on the multi-information display. Also, if the door is opened when the outside rear view mirror indicator is illuminated, a buzzer will sound as a warning.

B Outside rear view mirror indicators

When a vehicle or bicycle which may collide with a door when opened is detected, the outside rear view mirror indicator on the detected side will illuminate. When a door on the detected side is opened, the outside rear view mirror indicator will flash.

C Driving assist information indicator

Illuminates when the safe exit assist is turned off. At this time, "Safe Exit Assist OFF" will be displayed on the multi-information display.

■ Outside rear view mirror indicator visibility

In strong sunlight, the outside rear view mirror indicator may be difficult to see.

■ Buzzer

If the volume setting of the audio system is high or the surrounding area is loud, it may be difficult to hear the buzzer.

■ Customization

Some functions can be customized.
(→P.346)



WARNING

■ To ensure the system can operate properly

Safe exit assist sensors are installed behind the left and right sides of the rear bumper respectively. Observe the following to ensure the safe exit assist can operate correctly.

- Keep the sensors and the surrounding areas on the rear bumper clean at all times.

If a sensor or its surrounding area on the rear bumper is dirty or covered with snow, the Safe Exit Assist may not operate and a warning message will be displayed. In this situation, clear off the dirt or snow and drive the vehicle with the operation conditions of the SEA function satisfied for approximately 10 minutes. If the warning message does not disappear, have the vehicle inspected by your Toyota dealer.

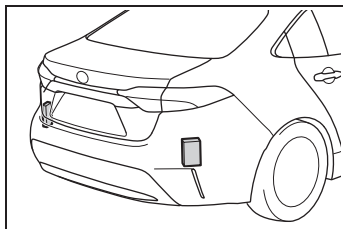

- Do not attach accessories, stickers (including transparent stickers), aluminum tape, etc. to a sensor or its surrounding area on the rear bumper.

- Do not subject a sensor or its surrounding area on the rear bumper to a strong impact.

If a sensor is moved even slightly off position, the system may malfunction and vehicles may not be detected correctly.

In the following situations, have your vehicle inspected by your Toyota dealer.

- A sensor or its surrounding area is subject to a strong impact.
- If the surrounding area of a sensor is scratched or dented, or part of them has become disconnected.
- Do not disassemble the sensor.
- Do not modify the sensor or surrounding area on the rear bumper.
- If a sensor or the rear bumper needs to be removed/installed or replaced, contact your Toyota dealer.
- Do not paint the rear bumper any color other than an official Toyota color.

Turning the Safe exit assist system ON/OFF

The safe exit assist can be enabled/disabled on  of the multi-information display. (→P.346)

When the safe exit assist is off, the driving assist information indicator will illuminate. At this time, "Safe Exit Assist OFF" will be displayed on the multi-information display. Each time the power switch is turned to ON, the safe exit assist is enabled.

■ Objects that can be detected by the Safe exit assist

When the safe exit assist detects the following vehicles or bicycles behind your vehicle using a rear side radar sensor, the occupants of the vehicle are informed through an outside rear view mirror indicator, buzzer, and the multi-information display.

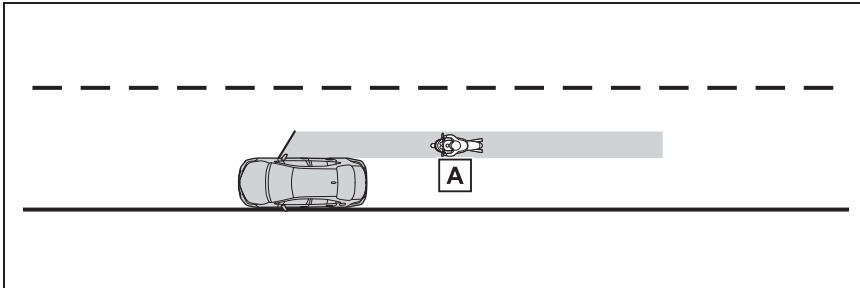

A Vehicle or bicycle which has a high possibility of colliding with a door when opened

■ The Safe exit assist detection areas

The areas that vehicles can be detected in are outlined below.

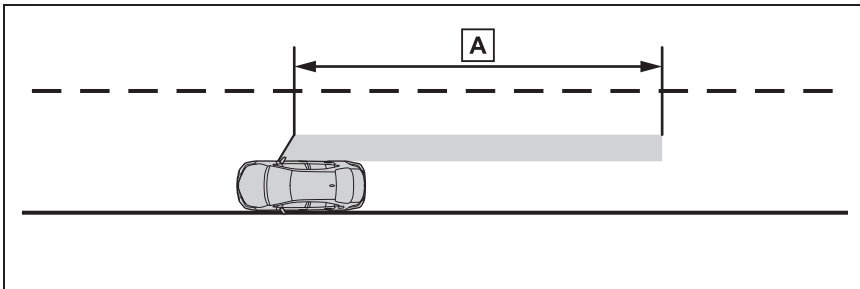

A Approximately 45 m (145 ft.) rearward from the front door*

*: The faster a vehicle or bicycle is approaching, the distance at which an outside rear view mirror indicator will illuminate or blink will become further.

■ The Safe exit assist is operational when

The Safe exit assist is operational when all of the following conditions are met:

- When the power switch is ON, less than 3 minutes have elapsed since the hybrid system was off, or less than 3 minutes have elapsed since a door was opened and someone has

entered the vehicle (the time which operation is possible may be extended if a door is opened and closed)

- Safe exit assist is on
- The vehicle is stopped.
- The shift lever is in a position other than R.

■ The Safe exit assist will detect a vehicle when

The Safe exit assist will detect a vehicle present in the detection area in the following situations:

- When the vehicle is stopped and a vehicle or bicycle, which is traveling parallel to the vehicle, is approaching within the area that a door opens

■ Conditions under which the system will not detect a vehicle

- Safe exit assist does not detect the following objects, vehicles, and bicycles:
 - Vehicles or bicycles which are approaching slowly*
 - Vehicles or bicycles which are determined to have a low possibility of colliding with a door when opened*
 - Vehicles or bicycles which are approaching from directly behind*
 - Vehicles or bicycles which are approaching from the front*
 - Guardrails, walls, signs, parked vehicles, and other stationary objects*
 - Pedestrians, animals, etc.*

*: Depending on the conditions, detection of a vehicle and/or object may occur.

- In situations such as the following, safe exit assist will not operate:
 - When 3 minutes or more have elapsed since the engine off (the time which operation is possible may be extended if a door is opened and closed)
 - When your vehicle is not completely stopped

■ Conditions under which the system may not function correctly

- The Safe exit assist may not detect vehicles correctly in the following situations:
 - When the sensor is misaligned due to a strong impact to the sensor or its surrounding area
 - When mud, snow, ice, a sticker, etc. is

covering the sensor or surrounding area on the rear bumper

- When the vehicle is stopped on a wet road surface, such as in a puddle, while in inclement weather, such as heavy rain, snow, fog, etc.
- When a vehicle or bicycle approaches from behind a nearby parked vehicle
- When an approaching vehicle or bicycle suddenly changes direction
- Immediately after a vehicle or bicycle starts moving
- When the trunk is open
- When a bicycle carrier, ramp, or other accessory is installed to the back of the vehicle
- When a parked vehicle, wall, sign, person or other stationary object is behind the vehicle
- When the vehicle is stopped at an angle to the road
- When a vehicle is traveling near an approaching vehicle or bicycle
- When an approaching vehicle or bicycle is traveling along a stationary object, such a wall or sign
- When a vehicle or bicycle is approaching at high speed
- When towing with the vehicle
- When stopped on a steep slope
- When stopped on a curve or at the exit of a curve
- Instances of the Safe exit assist unnecessarily detecting a vehicle and/or object may increase in the following situations:
 - When the sensor is misaligned due to a strong impact to the sensor or its surrounding area
 - When a vehicle or bicycle approaches from behind your vehicle at an angle
 - When the vehicle is stopped at an angle to the road
 - When a vehicle or bicycle approaches from behind a parked vehicle at an angle
 - When a parked vehicle, wall, sign, person or other stationary object is behind the vehicle
 - When an approaching vehicle or bicycle suddenly changes direction
 - When an approaching vehicle or bicy-

cle is traveling along a stationary object, such a wall or sign

- When the trunk is open
- When a bicycle carrier, ramp, or other accessory is installed to the back of the vehicle
- When a vehicle or bicycle is approaching at high speed
- When towing with the vehicle
- When stopped on a steep slope
- When stopped on a curve or at the exit of a curve

Driving mode select switch

The driving modes can be selected to suit driving condition.

Selecting a drive mode

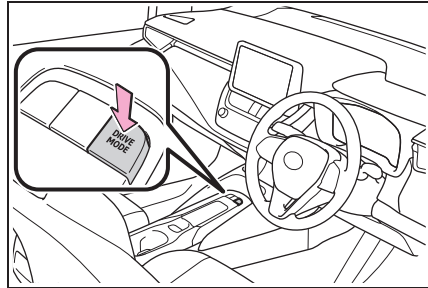

Each time the switch is pressed, the system changes between power mode, normal mode and Eco drive mode.

● Normal mode

Provides an optimal balance of fuel economy, quietness, and dynamic performance. Suitable for normal driving.

● Power mode

Controls the hybrid system to provide quick, powerful acceleration. Making it suitable for when agile driving response is desired, such as when driving on roads with many curves.

When the power mode is selected, power mode indicator comes on.

● Eco drive mode

Helps the driver accelerate in an eco-friendly manner and improve fuel economy through moderate throttle characteristics and by controlling the operation of the air conditioning system (heating/cooling).

When the Eco drive mode is selected, Eco drive mode indicator comes on.

■ Operation of the air conditioning system in Eco drive mode

Eco drive mode controls the heating/cooling operations and fan speed of the air conditioning system to enhance fuel efficiency. To improve air conditioning performance, perform the following operations:

- Turn off eco air conditioning mode (→P.233)
- Adjust the fan speed (→P.232)
- Turn off Eco drive mode

■ Automatic deactivation of power mode

If the power switch is turned off after driving in power mode, the drive mode will be changed to normal mode.

Driving assist systems

To keep driving safety and performance, the following systems operate automatically in response to various driving situations. Be aware, however, that these systems are supplementary and should not be relied upon too heavily when operating the vehicle.

Summary of the driving assist systems

■ ABS (Anti-lock Brake System)

Helps to prevent wheel lock when the brakes are applied suddenly, or if the brakes are applied while driving on a slippery road surface

■ Brake assist

Generates an increased level of braking force after the brake pedal is depressed when the system detects a panic stop situation

■ VSC (Vehicle Stability Control)

Helps the driver to control skidding when swerving suddenly or turning on slippery road surfaces.

Provides cooperative control of the ABS, TRC, VSC and EPS.

Helps to maintain directional stability when swerving on slippery road surfaces by controlling steering performance.

Helps the driver to control trailer sway by selectively applying brake

pressure for individual wheels and reducing driving torque when trailer sway is detected.

■ TRC (Traction Control)

Helps to maintain drive power and prevent the drive wheels from spinning when starting the vehicle or accelerating on slippery roads

■ Active Cornering Assist (ACA)

Helps to prevent the vehicle from drifting to the outer side by performing inner wheel brake control when attempting to accelerate while turning

■ Hill-start assist control

Helps to reduce the backward movement of the vehicle when starting on an uphill

■ EPS (Electric Power Steering)

Employs an electric motor to reduce the amount of effort needed to turn the steering wheel.

■ Emergency brake signal

When the brakes are applied suddenly, the emergency flashers automatically flash to alert the vehicle behind.

■ The Secondary Collision Brake

When the SRS airbag sensor detects a collision and the system operates, the brakes and brake lights are automatically controlled to reduce the vehicle speed and help reduce the possibility of further damage due to a secondary colli-

sion.

■ When the TRC/VSC/ABS systems are operating

The slip indicator light will flash while the TRC/VSC/ABS systems are operating.

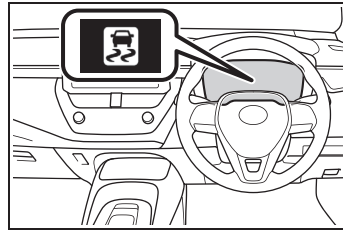

■ Disabling the TRC system

If the vehicle gets stuck in mud, dirt or snow, the TRC system may reduce power from the hybrid system to the

wheels. Pressing  to turn the system off may make it easier for you to rock the vehicle in order to free it.

To turn the TRC system off, quickly press and release .

The "Traction Control Turned OFF" will be shown on the multi-information display.

Press  again to turn the system back on.

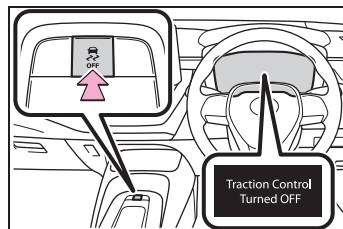

■ Turning off both TRC and VSC systems

To turn the TRC and VSC systems off, press and hold  for more than 3 seconds while the vehicle is stopped.

The VSC OFF indicator light will come

on and the “Traction Control Turned OFF” will be shown on the multi-information display.*

Press  again to turn the system back on.

*: PCS will also be disabled (only Pre-Collision warning is available). The PCS warning light will come on and a message will be displayed on the multi-information display. (→P.180)

■ **When the message is displayed on the multi-information display showing that TRC has been disabled**

even if  has not been pressed

TRC is temporarily deactivated. If the information continues to show, contact your Toyota dealer.

■ **Operating conditions of hill-start assist control**

When all of the following four conditions are met, the hill-start assist control will operate:

- The shift lever is in a position other than P or N (when starting off forward/backward on an upward incline).
- The vehicle is stopped
- The accelerator pedal is not depressed
- The parking brake is not engaged
- The power switch is in ON

■ **Automatic system cancelation of hill-start assist control**

The hill-start assist control will turn off in any of the following situations:

- The shift lever is shifted to P or N
- The accelerator pedal is depressed
- The parking brake is engaged
- 2 seconds at maximum elapsed after the brake pedal is released
- The power switch is in ON

■ **Sounds and vibrations caused by the ABS, brake assist, VSC, TRC and hill-start assist control systems**

- A sound may be heard from the engine compartment when the brake pedal is depressed repeatedly, when the hybrid system is started or just after the vehicle begins to move. This sound does not indicate that a malfunction has occurred in any of these systems.
- Any of the following conditions may occur when the above systems are operating. None of these indicates that a malfunction has occurred.
 - Vibrations may be felt through the vehicle body and steering.
 - A motor sound may be heard also after the vehicle comes to a stop.
 - The brake pedal may pulsate slightly after the ABS is activated.
 - The brake pedal may move down slightly after the ABS is activated.

■ **Active Cornering Assist operation sounds and vibrations**

When the Active Cornering Assist is operated, operation sounds and vibrations may be generated from the brake system, but this is not a malfunction.

■ **Automatic reactivation of TRC and VSC systems**

After turning the TRC and VSC systems off, the systems will be automatically re-enabled in the following situations:

- When the power switch is turned off
- If only the TRC system is turned off, the TRC will turn on when vehicle speed increases

If both the TRC and VSC systems are turned off, automatic re-enabling will not occur when vehicle speed increases.

■ **Operating conditions of Active Cornering Assist**

The system operates when the following occurs.

- TRC/VSC can operate

- The driver is attempting to accelerate while turning
- The system detects that the vehicle is drifting to the outer side
- The brake pedal is released

■ **Reduced effectiveness of the EPS system**

The effectiveness of the EPS system is reduced to prevent the system from overheating when there is frequent steering input over an extended period of time. The steering wheel may feel heavy as a result. Should this occur, refrain from excessive steering input or stop the vehicle and turn the hybrid system off. The EPS system should return to normal within 10 minutes.

■ **Operating conditions of emergency brake signal**

When the following conditions are met, the emergency brake signal will operate:

- The emergency flashers are off
- Actual vehicle speed is over 55 km/h (35 mph)
- The system judges from the vehicle deceleration that it is a sudden braking operation

■ **Automatic system cancellation of emergency brake signal**

The emergency brake signal will be canceled in any of the following situations:

- The emergency flashers are turned on
- The system judges from the vehicle deceleration that is not a sudden braking operation

■ **Secondary Collision Brake operating conditions**

The system operates when the SRS airbag sensor detects a collision while the vehicle is in motion.

However, the system does not operate when the components are damaged.

■ **Secondary Collision Brake automatic cancellation**

The system is automatically canceled in any of the following situations.

- The vehicle speed drops below approximately 0 km/h (0 mph)
- A certain amount of time elapses during operation
- The accelerator pedal is depressed a large amount



WARNING

■ **The ABS does not operate effectively when**

- The limits of tire gripping performance have been exceeded (such as excessively worn tires on a snow covered road).
- The vehicle hydroplanes while driving at high speed on wet or slick roads.

■ **Stopping distance when the ABS is operating may exceed that of normal conditions**

The ABS is not designed to shorten the vehicle's stopping distance. Always maintain a safe distance from the vehicle in front of you, especially in the following situations:

- When driving on dirt, gravel or snow-covered roads
- When driving with tire chains
- When driving over bumps in the road
- When driving over roads with potholes or uneven surfaces

**WARNING****■ TRC/VSC may not operate effectively when**

Directional control and power may not be achievable while driving on slippery road surfaces, even if the TRC/VSC system is operating. Drive the vehicle carefully in conditions where stability and power may be lost.

■ Active Cornering Assist does not operate effectively when

● Do not overly rely on Active Cornering Assist. Active Cornering Assist may not operate effectively when accelerating down slopes or driving on slippery road surfaces.

● When Active Cornering Assist frequently operates, Active Cornering Assist may temporarily stop operating to ensure proper operation of the brakes, TRC and VSC.

■ Hill-start assist control does not operate effectively when

● Do not overly rely on hill-start assist control. Hill-start assist control may not operate effectively on steep inclines and roads covered with ice.

● Unlike the parking brake, hill-start assist control is not intended to hold the vehicle stationary for an extended period of time. Do not attempt to use hill-start assist control to hold the vehicle on an incline, as doing so may lead to an accident.

■ When the TRC/ABS/VSC is activated

The slip indicator light flashes. Always drive carefully. Reckless driving may cause an accident. Exercise particular care when the indicator light flashes.

■ When the TRC/VSC systems are turned off

Be especially careful and drive at a speed appropriate to the road conditions. As these are the systems to help ensure vehicle stability and driving force, do not turn the TRC/VSC systems off unless necessary.

■ Replacing tires

Make sure that all tires are of the specified size, brand, tread pattern and total load capacity. In addition, make sure that the tires are inflated to the recommended tire inflation pressure level.

The ABS, TRC and VSC systems will not function correctly if different tires are installed on the vehicle. Contact your Toyota dealer for further information when replacing tires or wheels.

■ Handling of tires and the suspension

Using tires with any kind of problem or modifying the suspension will affect the driving assist systems, and may cause a system to malfunction.

■ Secondary Collision Brake

Do not rely solely upon the Secondary Collision Brake. This system is designed to help reduce the possibility of further damage due to a secondary collision, however, that effect changes according to various conditions. Overly relying on the system may result in death or serious injury.

Hybrid vehicle driving tips

For economical and ecological driving, pay attention to the following points:

Using Eco drive mode

When using Eco drive mode, the torque corresponding to the accelerator pedal depression amount can be generated more smoothly than it is in normal conditions. In addition, the operation of the air conditioning system (heating/cooling) will be minimized, improving the fuel economy. (→P.220)

Use of Hybrid System Indicator

The Eco-friendly driving is possible by keeping the indicate of Hybrid System Indicator within Eco area. (→P.72, 78)

Shift lever operation

Shift the shift lever to D when stopped at a traffic light, or driving in heavy traffic etc. Shift the shift lever to P when parking. When using the N, there is no positive effect on fuel consumption. In the N, the gasoline engine operates but electricity cannot be generated. Also, when using the air conditioning system, etc., the hybrid battery

(traction battery) power is consumed.

Accelerator pedal/brake pedal operation

- Drive your vehicle smoothly. Avoid abrupt acceleration and deceleration. Gradual acceleration and deceleration will make more effective use of the electric motor (traction motor) without having to use gasoline engine power.
- Avoid repeated acceleration. Repeated acceleration consumes hybrid battery (traction battery) power, resulting in poor fuel consumption. Battery power can be restored by driving with the accelerator pedal slightly released.

When braking

Make sure to operate the brakes gently and in a timely manner. A greater amount of electrical energy can be regenerated when slowing down.

Delays

Repeated acceleration and deceleration, as well as long waits at traffic lights, will lead to bad fuel economy. Check traffic reports before leaving and avoid delays as much as possible. When driving in

a traffic jam, gently release the brake pedal to allow the vehicle to move forward slightly while avoiding overuse of the accelerator pedal. Doing so can help control excessive gasoline consumption.

Highway driving

Control and maintain the vehicle at a constant speed. Before stopping at a toll booth or similar, allow plenty of time to release the accelerator and gently apply the brakes. A greater amount of electrical energy can be regenerated when slowing down.

Air conditioning

Use the air conditioning only when necessary. Doing so can help reduce excessive gasoline consumption.

In summer: When the ambient temperature is high, use the recirculated air mode. Doing so will help to reduce the burden on the air conditioning system and reduce fuel consumption as well.

In winter: Because the gasoline engine will not automatically cut out until it and the interior of the vehicle are warm, it will consume fuel. Also, fuel consumption can be improved by avoiding overuse of the heater.

Checking tire inflation pressure

Make sure to check the tire inflation pressure frequently. Improper tire inflation pressure can cause poor fuel economy.

Also, as snow tires can cause large amounts of friction, their use on dry roads can lead to poor fuel economy. Use tires that are appropriate for the season.

Luggage

Carrying heavy luggage will lead to poor fuel economy. Avoid carrying unnecessary luggage. Installing a large roof rack will also cause poor fuel economy.

Warming up before driving

Since the gasoline engine starts up and cuts out automatically when cold, warming up the engine is unnecessary. Moreover, frequently driving short distances will cause the engine to repeatedly warm up, which can lead to excess fuel consumption.

Winter driving tips

Carry out the necessary preparations and inspections before driving the vehicle in winter. Always drive the vehicle in a manner appropriate to the prevailing weather conditions.

Pre-winter preparations

- Use fluids that are appropriate to the prevailing outside temperatures.
- Engine oil
- Engine/power control unit coolant
- Washer fluid
- Have a service technician inspect the condition of the 12-volt battery.
- Have the vehicle fitted with four snow tires or purchase a set of tire chains for the front tires.

Ensure that all tires are the same size and brand, and that chains match the size of the tires.



WARNING

■ Driving with snow tires

Observe the following precautions to reduce the risk of accidents. Failure to do so may result in a loss of vehicle control and cause death or serious injury.

- Use tires of the size specified.
- Maintain the recommended level of air pressure.

- Do not drive at speeds in excess of the speed limit or the speed limit specified for the snow tires being used.

- Use snow tires on all, not just some wheels.

■ Driving with tire chains

Observe the following precautions to reduce the risk of accidents. Failure to do so may result in the vehicle being unable to be driven safely, and may cause death or serious injury.

- Do not drive in excess of the speed limit specified for the tire chains being used, or 50 km/h (30 mph), whichever is lower.

- Avoid driving on bumpy road surfaces or over potholes.

- Avoid sudden acceleration, abrupt steering, sudden braking and shifting operations that cause sudden engine braking.

- Slow down sufficiently before entering a curve to ensure that vehicle control is maintained.

- Do not use LTA (Lane Tracing Assist) system.

- Do not use LDA (Lane Departure Alert) system.

Before driving the vehicle

Perform the following according to the driving conditions:

- Do not try to forcibly open a window or move a wiper that is frozen. Pour warm water over the frozen area to melt the ice. Wipe away the water immediately to prevent it from freezing.
- To ensure proper operation of

the climate control system fan, remove any snow that has accumulated on the air inlet vents in front of the windshield.

- Check for and remove any excess ice or snow that may have accumulated on the exterior lights, outside rear view mirrors, windows, vehicle's roof, chassis, around the tires or on the brakes.
- Remove any snow or mud from the bottom of your shoes before getting in the vehicle.

When driving the vehicle

Accelerate the vehicle slowly, keep a safe distance between you and the vehicle ahead, and drive at a reduced speed suitable to road conditions.

When parking the vehicle

- Turn automatic mode of the parking brake off. Otherwise, the parking brake may freeze and not be able to be released automatically.

Also, avoid using the following as the parking brake may operate automatically, even if automatic mode is off.

- Brake hold system
- Park the vehicle and shift the shift lever to P without setting the parking brake. The parking brake may freeze up, preventing it from being released. If the vehicle is

parked without setting the parking brake, make sure to block the wheels.

Failure to do so may be dangerous because it may cause the vehicle to move unexpectedly, possibly leading to an accident.

- When the parking brake is in automatic mode, release the parking brake after shifting the shift lever to P. (→P.150)
- If the vehicle is parked without setting the parking brake, confirm that the shift lever cannot be moved out of P.
- If the vehicle is left parked with the brakes damp in cold temperatures, there is a possibility of the brakes freezing.

Selecting tire chains

Use the correct tire chain size when mounting the tire chains.

Chain size is regulated for each tire size.

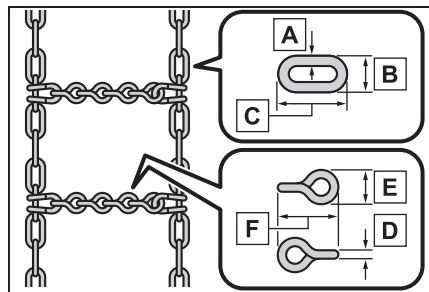

A Side chain (3 mm [0.12 in.] in diameter)

B Side chain (10 mm [0.39 in.] in

width)

- C** Side chain (30 mm [1.18 in.] in length)
- D** Cross chain (4 mm [0.16 in.] in diameter)
- E** Cross chain (14 mm [0.55 in.] in width)
- F** Cross chain (25 mm [0.98 in.] in length)

Regulations on the use of tire chains

Regulations regarding the use of tire chains vary depending on location and type of road. Always check local regulations before installing chains.

■ Tire chain installation

Observe the following precautions when installing and removing chains:

- Install and remove tire chains in a safe location.
- Install tire chains on the front tires only. Do not install tire chains on the rear tires.
- Install tire chains on the front tires as tightly as possible. Retighten chains after driving 0.5—1.0 km (1/4—1/2 mile).
- Install tire chains following the instructions provided with the tire chains.

- 5-1. Using the air conditioning system and defogger**
 - Automatic air conditioning system**232**
 - Seat heaters**236**
- 5-2. Using the interior lights**
 - Interior lights list.....**238**
- 5-3. Using the storage features**
 - List of storage features**240**
- 5-4. Other interior features**
 - Other interior features.....**244**

Automatic air conditioning system

Air outlets are automatically selected and fan speed is automatically adjusted according to the set temperature setting.

Air conditioning controls

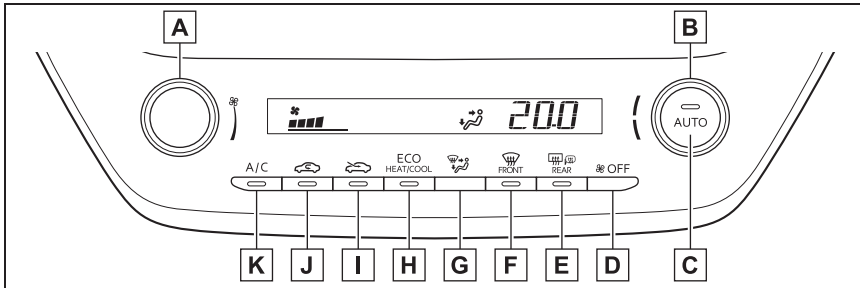

A Fan speed control switch

B Temperature control switch

C Automatic mode switch

D Off switch

E Rear window defogger and outside rear view mirror defoggers switch

F Windshield defogger switch

G Airflow mode control switch

H Eco air conditioning mode switch

I Outside air mode switch

J Recirculated air mode switch

K "A/C" switch

■ Adjusting the temperature setting

To adjust the temperature setting, turn the temperature control switch clockwise (warm) or counterclockwise (cool).

If "A/C" switch is not pressed, the system will blow ambient temperature air

or heated air.

■ Setting the fan speed

To adjust the fan speed, turn the fan speed control switch clockwise (increase) or counterclockwise (decrease).

Pressing the off switch to turns off the fan.

■ Change the airflow mode

Press the airflow mode control switch.

The airflow mode changes as follows each time the switch is pressed.

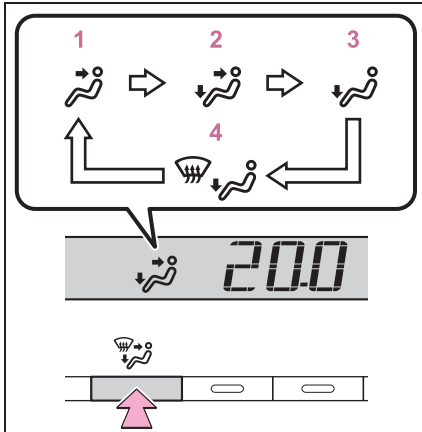

- 1 Upper body
- 2 Upper body and feet
- 3 Feet
- 4 Feet and the windshield defogger operates

■ Switching between outside air and recirculated air modes

- To change to recirculated air mode, press the recirculated air mode switch.

The indicator illuminates on the recirculated air mode switch.

- To change to outside air mode, press the outside air mode switch.

The indicator illuminates on the outside air mode switch.

■ Set cooling and dehumidification function

Press the “A/C” switch.

When the function is on, the indicator illuminates on the “A/C” switch.

■ Defogging the windshield

Defoggers are used to defog the windshield and front side windows.

Press the windshield defogger switch.

Change the air mode to outside air mode if it is currently set to recirculated air mode. (The mode may change automatically.)

To defog the windshield and the side windows quickly, turn the air flow and temperature up.

To return to the previous mode, press the windshield defogger switch again when the windshield is defogged.

When the windshield defogger switch is on, the indicator illuminates on the windshield defogger switch.

■ Defogging the rear window and outside rear view mirrors

Defoggers are used to defog the rear window, and to remove rain-drops, dew and frost from the outside rear view mirrors.

Press the rear window and outside rear view mirror defoggers switch.

The defoggers will automatically turn off after a while.

When the rear window and outside rear view mirror defoggers switch is on, the indicator illuminates on the rear window and outside rear view mirror defoggers switch.

■ Eco air conditioning mode

The air conditioning is controlled with low fuel consumption prior-

itized such as reducing fan speed, etc.

Press the eco air conditioning mode switch.

When the eco air conditioning mode is on, the indicator illuminates on the eco air conditioning mode switch.

■ Fogging up of the windows

- The windows will easily fog up when the humidity in the vehicle is high. Turning "A/C" on will dehumidify the air from the outlets and defog the windshield effectively.
- If you turn "A/C" off, the windows may fog up more easily.
- The windows may fog up if the recirculated air mode is used.

■ When driving on dusty roads

Close all windows. If dust thrown up by the vehicle is still drawn into the vehicle after closing the windows, it is recommended that the air intake mode be set to outside air mode and the fan speed to any setting except off.

■ Outside/recirculated air mode

- Setting to the recirculated air mode temporarily is recommended in preventing dirty air from entering the vehicle interior and helping to cool the vehicle when the outside air temperature is high.
- Outside/recirculated air mode may automatically switch depending on the temperature setting or the inside temperature.

■ Eco air conditioning mode

When Eco drive mode is selected using the driving mode select switch, eco air conditioning mode turns on.

When a drive mode other than Eco drive mode is selected, eco air conditioning mode may turn off.

■ Operation of the air conditioning system in Eco drive mode

- In Eco drive mode, the air conditioning system is controlled as follows to prioritize fuel efficiency:
 - Engine speed and compressor operation controlled to restrict heating/cooling capacity
 - Fan speed restricted when automatic mode is selected
- To improve air conditioning performance, perform the following operations:
 - Turn off eco air conditioning mode (→P.233)
 - Adjust the fan speed
 - Turn off Eco drive mode (→P.220)

■ When the outside temperature falls to nearly 0°C (32°F)

The dehumidification function may not operate even when "A/C" switch is pressed.

■ Ventilation and air conditioning odors

- To let fresh air in, set the air conditioning system to the outside air mode.
- During use, various odors from inside and outside the vehicle may enter into and accumulate in the air conditioning system. This may then cause odor to be emitted from the vents.
- To reduce potential odors from occurring:
 - It is recommended that the air conditioning system be set to outside air mode prior to turning the vehicle off.
 - The start timing of the blower may be delayed for a short period of time immediately after the air conditioning system is started in automatic mode.
- When parking, the system automatically switches to outside air mode to encourage better air circulation throughout the vehicle, helping to reduce odors that occur when starting the vehicle.

■ Air conditioning filter

→P.276

■ Customization

Some functions can be customized.
(→P.346)



WARNING

■ To prevent the windshield from fogging up

Do not use the windshield defogger switch during cool air operation in extremely humid weather. The difference between the temperature of the outside air and that of the windshield can cause the outer surface of the windshield to fog up, blocking your vision.

■ When the outside rear view mirror defoggers are operating

Do not touch the outside rear view mirror surfaces, as they can become very hot and burn you.



NOTICE

■ To prevent 12-volt battery discharge

Do not leave the air conditioning system on longer than necessary when the hybrid system is off.

Using automatic mode

- 1 Press the automatic mode switch.
- 2 Adjust the temperature setting.
- 3 To stop the operation, press the off switch.

If the fan speed setting or air flow modes are operated, the automatic mode indicator goes off. However, automatic mode for functions other than that operated is maintained.

■ Using automatic mode

Fan speed is adjusted automatically according to the temperature setting and the ambient conditions.

Therefore, the fan may stop for a while until warm or cool air is ready to flow immediately after the automatic mode switch pressed.

Air outlet layout and operations

■ Location of air outlets

The air outlets and air volume changes according to the selected air flow mode.

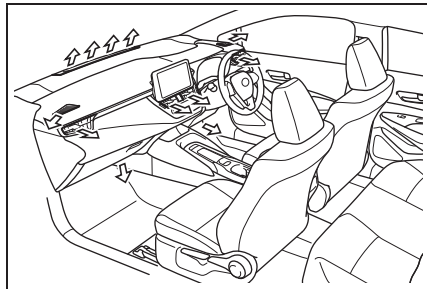

■ Adjusting the position of and opening and closing the air outlets

► Front center

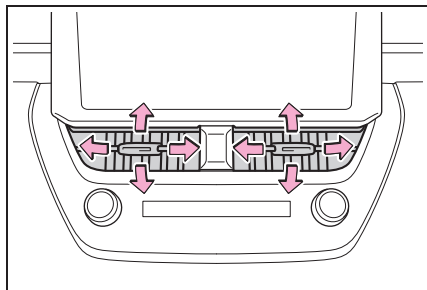

Direct air flow to the left or right, up or down

► Front right-hand side

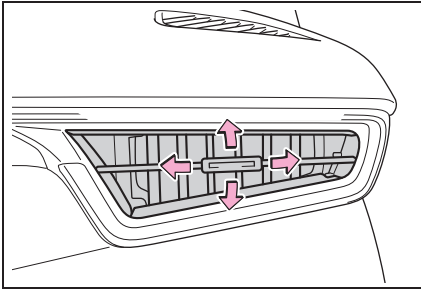

Direct air flow to the left or right, up or down

► Front left-hand side

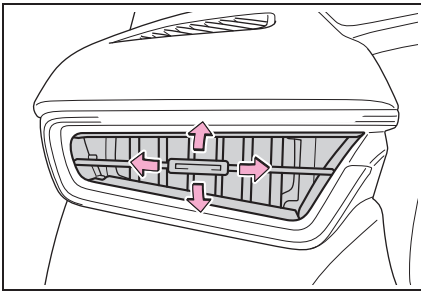

Direct air flow to the left or right, up or down

! WARNING

■ **To prevent the windshield defogger from operating improperly**

Do not place anything on the instrument panel which may cover the air outlets. Otherwise, air flow may be obstructed, preventing the windshield defoggers from defogging.

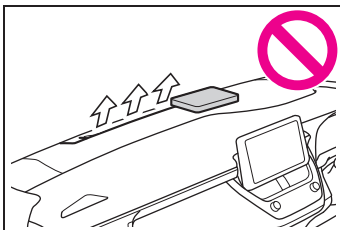

Seat heaters*

*: If equipped

Warm up the seat upholstery

! WARNING

■ **To prevent minor burn injuries**

Care should be taken if anyone in the following categories comes in contact with the seats when the heater is on:

- Babies, small children, the elderly, the sick and the physically challenged
- Persons with sensitive skin
- Persons who are fatigued
- Persons who have taken alcohol or drugs that induce sleep (sleeping drugs, cold remedies, etc.)

! NOTICE

■ **To prevent damage to the seat heaters**

Do not put heavy objects that have an uneven surface on the seat and do not stick sharp objects (needles, nails, etc.) into the seat.

■ **To prevent 12-volt battery discharge**

Do not use the functions when the hybrid system is off.

Operation instruction

Turns seat heaters on/off

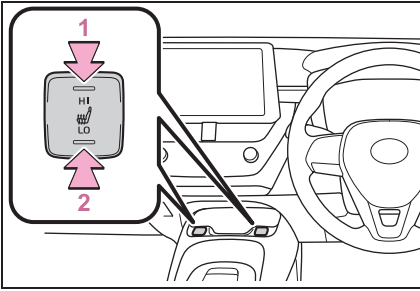

1 High temperature

2 Low temperature

When the seat heater is on, the indicator illuminates on the seat heater switch.

When not in use, put the switch in the neutral position. The indicator will turn off.

■ **The seat heaters can be used when**

The power switch is in ON.



WARNING

■ **To prevent overheating and minor burn injuries**

Observe the following precautions when using the seat heaters.

- Do not cover the seat with a blanket or cushion when using the seat heater.
- Do not use seat heater more than necessary.

Interior lights list

Location of the interior lights

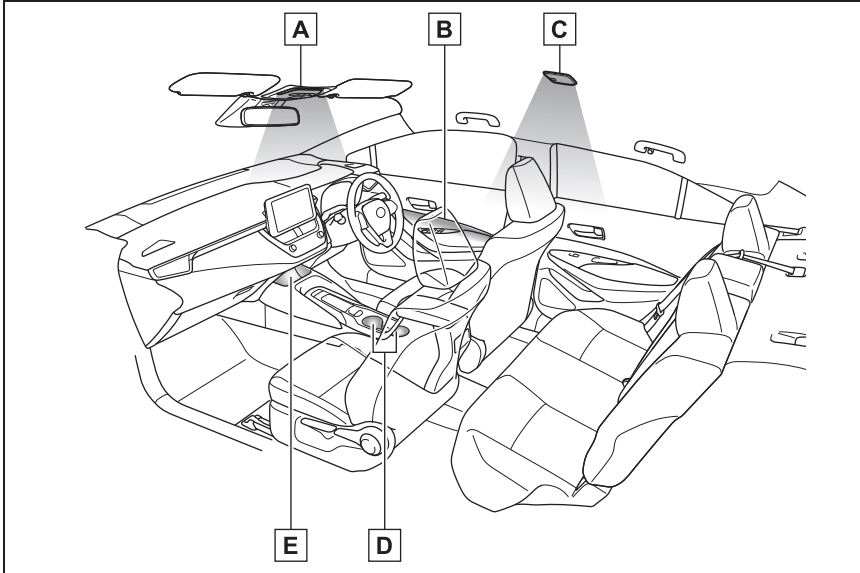

- A** Front interior/personal lights (→P.238)
- B** Door trim lights (if equipped)
- C** Rear interior light (→P.239)
- D** Cup holder lights (if equipped)
- E** Center tray light (if equipped)

Operating the interior lights

■ Front

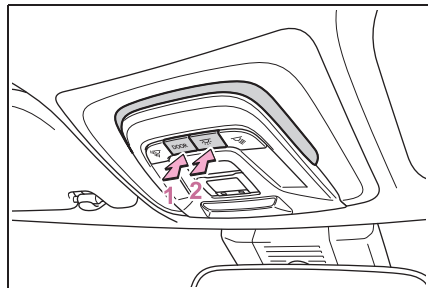

- 1** Turns the door position on/off
When a door is opened while the door

position is on, the lights turn on.

2 Turns the lights on/off

■ Rear

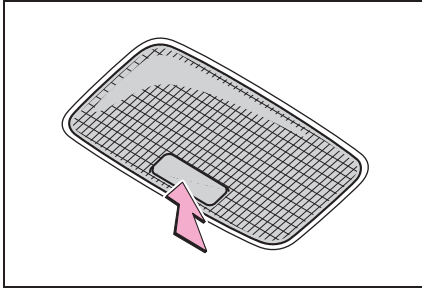

Turns the lights on/off

When the door position is on for the front interior lights, the rear interior light will turn on when a door is open and turn off when all of them are closed.

When the rear interior light is on linked to the door position for the front interior lights, it will not turn off even though the switch is pressed.

Operating the personal lights

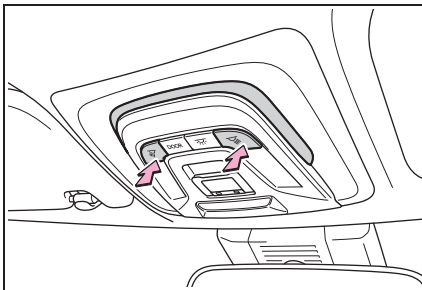

Turns the lights on/off

■ Illuminated entry system

The lights automatically turn on/off according to the power switch mode, the

presence of the electronic key, whether the doors are locked/unlocked, and whether the doors are open/closed.

■ To prevent the 12-volt battery from being discharged

If the interior lights remain on when the power switch is turned off, the lights will go off automatically after 20 minutes.

■ The interior lights may turn on automatically when

If any of the SRS airbags deploy (inflate) or in the event of a strong rear impact, the interior lights will turn on automatically.

The interior lights will turn off automatically after approximately 20 minutes. The interior lights can be turned off manually. However, in order to help prevent further collisions, it is recommended that they be left on until safety can be ensured.

(The interior lights may not turn on automatically depending on the force of the impact and conditions of the collision.)

■ Customization

Some functions can be customized. (→P.346)

⚠ NOTICE

■ To prevent 12-volt battery discharge

Do not leave the lights on longer than necessary when the hybrid system is off.

List of storage features

Location of the storage features

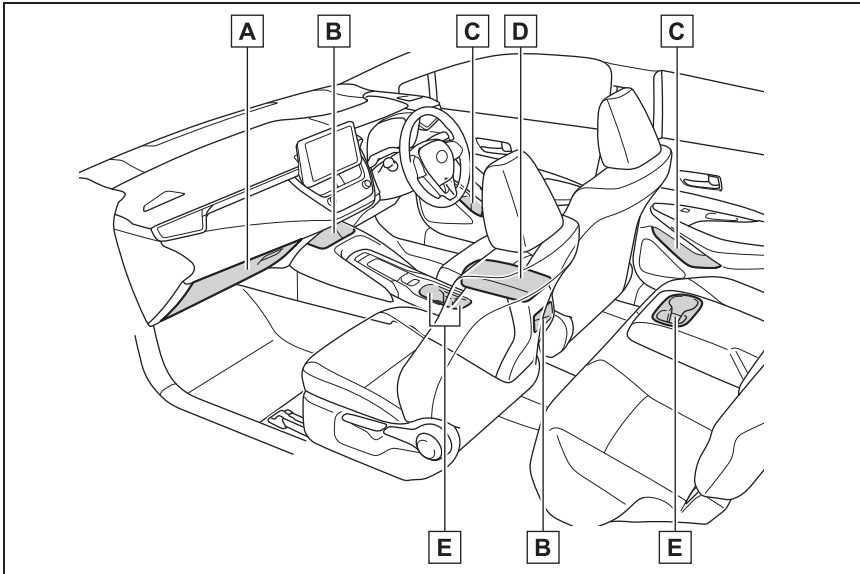

- A** Glove box (→P.241)
- B** Open trays (if equipped) (→P.242)
- C** Bottle holders/door pockets (→P.241)
- D** Console box (→P.242)
- E** Cup holders (→P.241)



WARNING

■ Items that should not be left in the storage spaces

Do not leave glasses, lighters or spray cans in the storage spaces, as this may cause the following when cabin temperature becomes high:

- Glasses may be deformed by heat or cracked if they come into contact with other stored items.

- Lighters or spray cans may explode. If they come into contact with other stored items, the lighter may catch fire or the spray can may release gas, causing a fire hazard.

Glove box

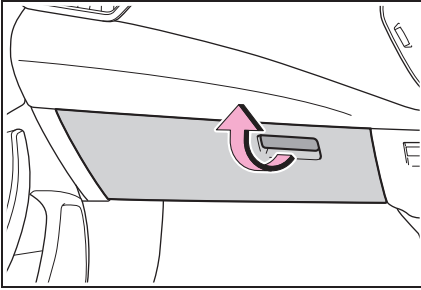

Pull up the lever to open the glove box.

■ Glove box light

The glove box light turns on when the tail lights are on.

⚠ WARNING

■ Caution while driving

Keep the glove box closed. In the event of sudden braking or sudden swerving, an accident may occur due to an occupant being struck by the open glove box or the items stored inside.

Cup holders

► Front

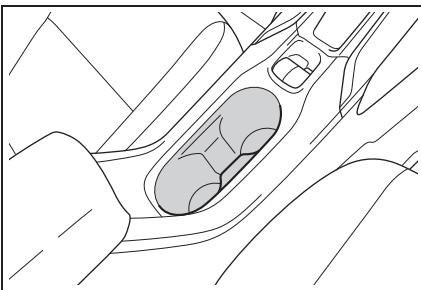

► Rear

Pull the armrest down.

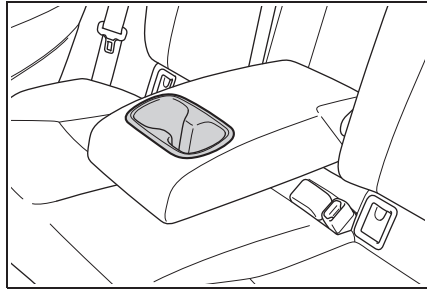

⚠ WARNING

■ Items unsuitable for the cup holder

Do not place anything other than cups or beverage cans in the cup holders. Other items may be thrown out of the holders in the event of an accident or sudden braking and cause injury. If possible, cover hot drinks to prevent burns.

Bottle holders

► Front

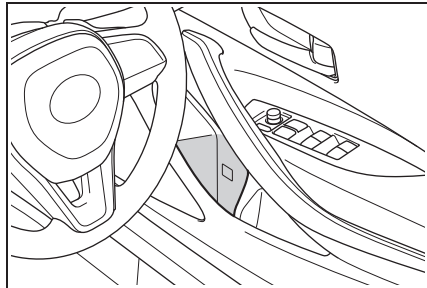

► Rear

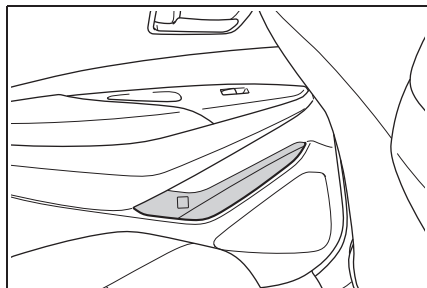

■ Bottle holders

- When storing a bottle, close the cap.
- The bottle may not be stored depending on its size or shape.

⚠ WARNING

■ Items unsuitable for the bottle holders

Do not place anything other than a bottle in the bottle holders. Other items may be thrown out of the holders in the event of an accident or sudden braking and cause injury.

Console box

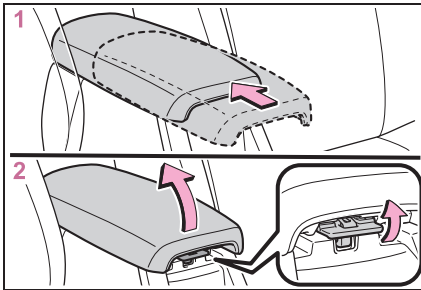

- 1 Slide the lid to the rear most position.
- 2 Lift the lid while pulling up the knob.

■ Slide function

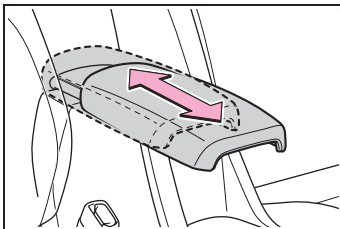

The console box lid can be slid forward or backward.

⚠ WARNING

■ Caution while driving

Keep the console box closed. Injuries may result in the event of an accident or sudden braking.

Open trays

- ▶ Front (if equipped)

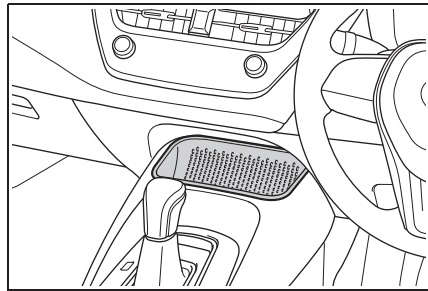

- ▶ Rear

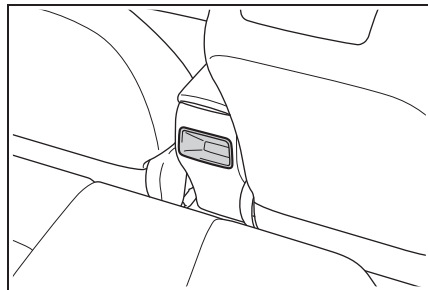

⚠ WARNING

■ Caution while driving

Observe the following precautions when putting items in the open tray. Failure to do so may cause items to be thrown out of the tray in the event of sudden braking or steering. In these cases, the items may interfere with pedal operation or cause driver distraction, resulting in an accident.

- Do not store items in the tray that can easily shift or roll out.

**WARNING**

- Do not stack items in the tray higher than the tray's edge.
- Do not put items in the tray that may protrude over the tray's edge.

Other interior features

USB charging port (if equipped)

The USB charging port are used to supply 3.0 A of electricity at 5 V to external devices.

The USB charging port are for charging only. They are not designed for data transfer or other purposes.

Depending on the external device, it may not charge properly. Refer to the manual included with the device before using a USB charging port.

■ Using the USB charging port

► Front

Lift the lid while pulling up the knob.

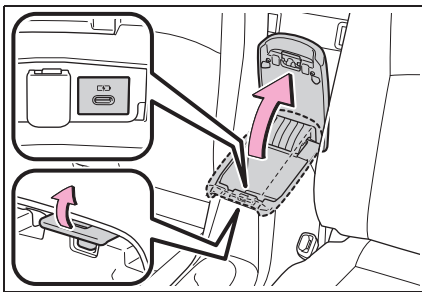

► Rear

Open the lid.

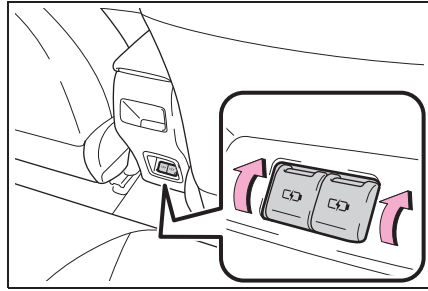

■ The USB charging port can be used when

The power switch is in ACC or ON.

■ Situations in which the USB charging port may not operate correctly

- If a device which consumes more than 3.0 A at 5 V is connected
- If a device designed to communicate with a personal computer, such as a USB memory device, is connected
- If the connected external device is turned off (depending on device)
- If the temperature inside the vehicle is high, such as after the vehicle has been parked in the sun

■ About connected external device

Depending on the connected external device, charging may occasionally be suspended and then start again. This is not a malfunction.

⚠ NOTICE

■ To prevent damage to the USB charging port

- Do not insert foreign objects into the port.
- Do not spill water or other liquids into the port.
- Rear console: When the USB charging ports are not in use, close the lids. If a foreign object or liquid enters a port may cause a short circuit.

 NOTICE

- Do not apply excessive force to or impact the USB charging port.
- Do not disassemble or modify the USB charging port.
- **To prevent damage to external devices**
 - Do not leave external devices in the vehicle. The temperature inside the vehicle may become high, resulting in damage to an external device.
 - Do not push down on or apply unnecessary force to an external device or the cable of an external device while it is connected.
- **To prevent 12-volt battery discharge**

Do not use the USB charging port for a long period of time with the hybrid system stopped.

Power outlet

The power outlet can be used for 12 V accessories that run on less than 10 A.

Lift the lid while pulling up the knob and open the power outlet lid.

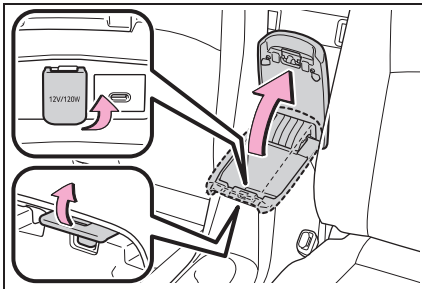

■ **The power outlet can be used when**

The power switch is in ACC or ON.

■ **When stopping the hybrid system**

Disconnect electrical devices with charging functions, such as mobile battery packs.

If such devices are left connected, the hybrid system may not stop normally.

 NOTICE

■ **To prevent the fuse from being blown**

Do not use an accessory that uses more than 12 V 10 A.

■ **To avoid damaging the power outlet**

Close the power outlet lid when the power outlet is not in use. Foreign objects or liquids that enter the power outlet may cause a short circuit.

■ **To prevent 12-volt battery discharge**

Do not use the power outlet longer than necessary when the hybrid system is off.

Wireless charger (if equipped)

A portable device, such as a smartphone or mobile battery, can be charged by just placing it on the charging area, provided the device is compatible with the Qi wireless charging standard created by the Wireless Power Consortium.

The wireless charger cannot be used with a portable device that is larger than the charging area. Additionally, depending on the portable device, the wireless charger may not operate properly. Refer to the operation manual of the portable

device.

■ The “Qi” symbol

The “Qi” symbol is a trademark of the Wireless Power Consortium.



■ Name for all parts

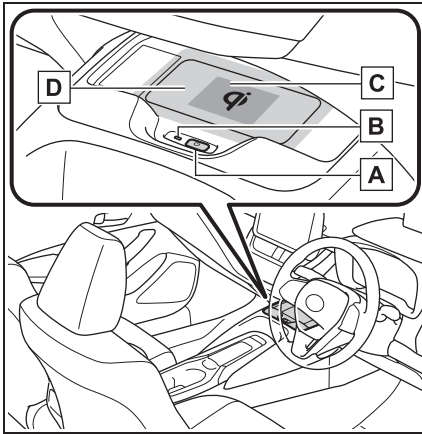

- A** Power supply switch
- B** Operation indicator light
- C** Charge area *
- D** Charging tray

*: Portable devices and wireless chargers contain charging coils. The charging coil in the wireless charger can be moved within the charge area near the center of the charging tray. If the charging coil inside a portable device is detected in the charge area, the charging coil inside the wireless charger will move toward it and start charging. If the charging coil inside a portable device moves outside of the charge area, charging will automatically stop.

If 2 or more portable devices are placed on the charging tray, their charging coils may not be properly detected and they may not be charged.

■ Using the wireless charger

- 1** Press the power supply switch of the wireless charger.

Pressing the switch again turns the wireless charger off. When turned on, the operation indicator light (green) comes on. When the power switch is turned off, the on/off state of the wireless charger will be memorized.

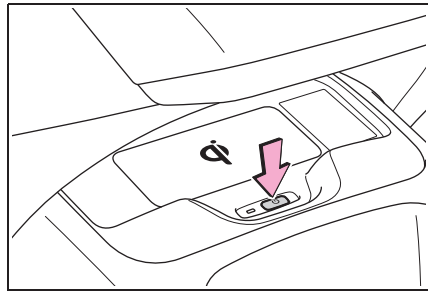

- 2** Place a portable device on the charging area with its charging surface facing down.

While charging, the operation indicator light (orange) will be illuminated. If charging does not begin, move the portable device as close to the center of the charging area as possible. If charging is not performed, the operation indicator light will slowly illuminate in green and orange alternatively and a sound of charging coil operation may be heard repeatedly. Depending on the portable device, its charging coil may not be in the center of the device. In this case, place the portable device so that its charging coil is centered in the charging area. When charging is complete, the operation indicator light (green) will illuminate.

nate.

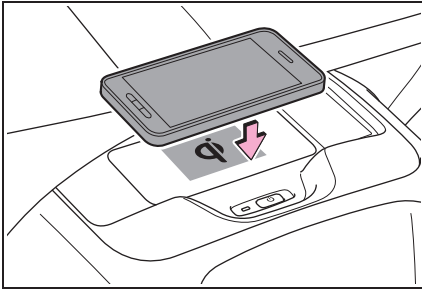

■ **Recharging function**

- If a certain amount of time has elapsed since charging completed and the portable device

■ **Operation indicator light status**

Operation indicator light	State
Off	The wireless charger is off
Green (illuminated)	Standby (charging is possible)
	Charging is complete*
Orange (illuminated)	A portable device has been placed on the charging area (identifying the portable device)
	Charging in progress

*: Depending on the portable device, the operation indicator light may stay illuminated (orange) after charging has completed.

- If the operation indicator light blinks

If an error is detected, the operation indicator light will blink (orange). Take the appropriate measures according to the table below.

has not been moved, the wireless charger will restart charging.

- If a portable device is moved significantly within the charging area, the charging coil may disconnect and charging may temporarily be stopped. However, if a charging coil is detected within the charging area, the charging coil inside the wireless charger will move near the other coil and charging will resume.

Operation indicator light	Suspected cause	Measure
Blinks (orange) at a one second interval continuously	Vehicle to charger communication failure.	If the hybrid system is turned on, off and then restart the hybrid system. If the power switch is in ACC, start the hybrid system.
Blinks (orange) 3 times repeatedly	A foreign object exists between the portable device and charging area.	Remove the foreign object.
	Portable device is not positioned properly on the charging area.	If there is a case or cover attached to the portable device, remove it.
Blinks (orange) 4 times repeatedly	The temperature of the wireless charger is excessively high.	Stop charging, remove the portable device from the charging tray, wait for the temperature to drop, and then start charging again.

■ **The wireless charger can be operated when**

The power switch is in ACC or ON.

■ **Portable devices that can be charged**

- Portable devices compatible with the Qi wireless charging standard can be charged by the wireless charger. However, compatibility with all devices which meet the Qi wireless charging standard is not guaranteed.
- The wireless charger is designed to supply low power electricity (5 W or less) to a cellular phone, smartphone, or other portable device.

■ **If a cover or accessory is attached to the portable device**

Do not charge a portable device if a cover or accessory which is not Qi compatible is attached. Depending on the type of cover (including for certain genuine manufacture parts) and/or accessory attached, it may not be possible to charge the portable device. If the portable device is placed on the charging

area and does not charge, remove the cover and/or accessories.

■ **If interference is heard in AM radio broadcasts while charging**

Turn off the wireless charger and check if the noise is reduced. If noise is reduced, press and hold the power supply switch of the wireless charger for 2 seconds. The frequency of the wireless charger is changed and noise may be reduced. When the frequency is changed, the operation indicator light will blink (orange) 2 times.

■ **Charging precautions**

- If the electronic key cannot be detected in the cabin, charging cannot be performed. When a door is opened and closed, charging may be temporarily suspended.
- While charging, the wireless charger and the portable device will become warm. This is not a malfunction. If a portable device becomes warm while charging and charging stops due to the protection function of the portable device,

wait until the portable device cools down and charge it again.

■ Sound generated during operation

When the power supply switch is turned on or while a portable device is being identified, operation sounds may be heard. This is not a malfunction.

■ Cleaning the wireless charger

→P.257



WARNING

■ Caution while driving

When charging a portable device, for safety reasons, the driver should not operate the main part of the portable device while driving.

■ Caution while in motion

Do not charge lightweight devices such as wireless headphones while in motion. These devices are very light and may be ejected from the charging tray, which may lead to unforeseen accidents.

■ Caution regarding interference with electronic devices

People with implantable cardiac pacemakers, cardiac resynchronization therapy pacemakers or implantable cardioverter defibrillators, as well as any other electrical medical device, should consult their physician about the usage of the wireless charger.

■ To prevent damage or burns

Observe the following precautions. Failure to do so may result in a equipment failure and damage, catch fire, burns due to overheat or electric shock.

- Do not insert any metallic objects between the charge area and the portable device while charging
- Do not attach an aluminum sticker or other metallic object to the charge area.

- Do not attach an aluminum sticker or other metallic object to the side of the portable device (or to its case or cover) that touches the charge area.
- Do not use the charging tray as a small storage space.
- Do not subject to a strong force or impact.
- Do not disassemble, modify or remove.
- Do not charge devices other than specified portable devices.
- Keep away from magnetic items.
- Do not charge devices if the charge area is covered in dust.
- Do not cover with a cloth or similar material.



NOTICE

■ Situations in which the function may not operate normally

Devices may not be charged normally in the following situations.

- The portable device is fully charged
- The portable device is being charged with a cable connected
- There is foreign matter between the charge area and portable device
- Charging has caused the portable device to heat up
- The temperature around the charging tray is 35°C (95°F) or higher, such as in extreme heat
- The portable device is placed with its charging side facing up
- The portable device is placed in an area misaligned from the charge area

**NOTICE**

- The portable device is larger than the charging tray
- A foldable and portable device is placed outside the charge area
- The camera lens protrudes 3 mm (0.12 in) or more from the surface of the portable device
- The vehicle is in an area where strong electrical waves or noise are emitted, such as near a television tower, power plant, gasoline station, broadcasting station, large display, airport, etc.
- Any of the following objects that is 2 mm (0.08 in) or thicker is between the charging side of the portable device and the charge area
 - Thick cases or covers
 - A case or cover attached with an uneven or tilted surface, so that the charging side is not flat
 - Thick decorations
 - Accessories, such as finger rings, straps, etc.
- When the portable device is in contact with, or is covered by any of the following metallic objects:
 - A card that has metal on it, such as aluminum foil, etc.
 - A pack of cigarettes that includes aluminum foil
 - A wallet or bag that is made of metal
 - Coins
 - A heating pad
 - CDs, DVDs or other media
 - A metal accessory
 - A case or cover made of metal

- A case which has magnet in it on the charging side of the portable device.
- Electric wave type wireless remote controls are being used nearby
- 2 or more portable devices are placed on the charging tray at the same time

If charging is abnormal or the operation indicator light continues to flash for any other reason, the wireless charger may be malfunctioning. Contact your Toyota dealer.

■ To prevent malfunctions and data corruptions

- When charging, bringing a credit, or other magnetic card, or magnetic storage media close to the charge area may clear any stored data due to magnetic influence. Also, do not bring a wristwatch or other precision instrument close to the charge area since doing so may cause it to malfunction.
- Do not charge with a non-contact IC card such as a transportation system IC card inserted between the charging side of a portable device and the charge area. The IC chip may become extremely hot and damage the portable device or IC card. Be especially careful not to charge a portable device inside a case or cover with a non-contact IC card attached.
- Do not leave portable devices inside the vehicle. The inside of the vehicle can become hot in extreme heat, which could cause a malfunction.

 NOTICE

■ **If the smartphone OS has been updated**

If the smartphone OS has been updated to a newer version, its charging specifications may have changed significantly. For details, check the information on the manufacturer's website.

■ **To prevent 12-volt battery discharge**

Do not use the wireless charger for a long period of time with the hybrid system stopped.

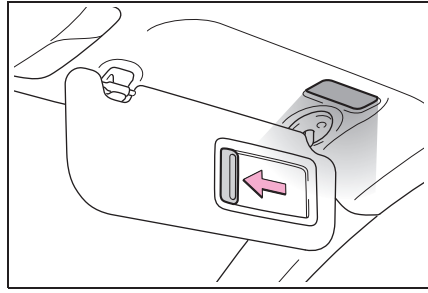

■ **To prevent 12-volt battery discharge**

If the vanity lights remain on when the power switch is OFF, the lights will go off automatically after 20 minutes.

Sun visors

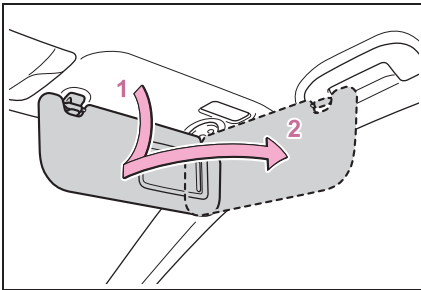

- 1 To set the visor in the forward position, flip it down.
- 2 To set the visor in the side position, flip down, unhook, and swing it to the side.

Vanity mirrors

Slide the cover to open.

The vanity light turns on.

 NOTICE

■ **To prevent the 12-volt battery from being discharged**

Do not leave the vanity lights on for extended periods while the hybrid system is off.

Armrest

Fold down the armrest for use.

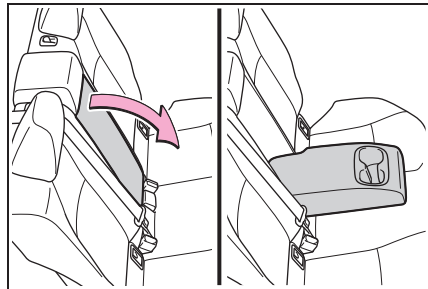

 NOTICE

■ **To prevent damage to the armrest**

Do not apply too much load on the armrest.

Assist grips

An assist grip installed on the ceiling can be used to support your body while sitting on the seat.

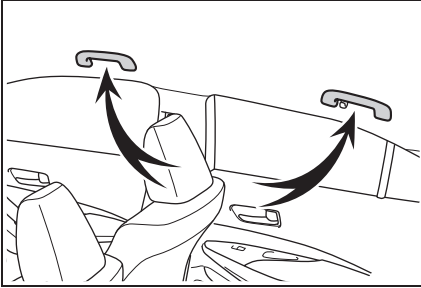

WARNING

■ Assist grip

Do not use the assist grip when getting in or out of the vehicle or rising from your seat.



NOTICE

■ To prevent damage to the assist grip

Do not hang any heavy object or put a heavy load on the assist grip.

Coat hooks

The coat hooks are provided with the rear assist grips.

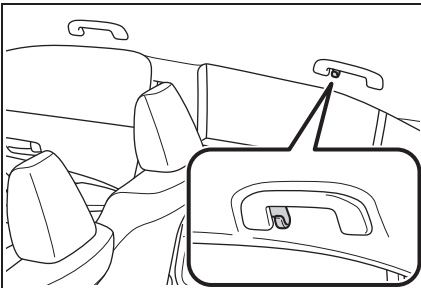

WARNING

■ Items that cannot be hung on the coat hook

Do not hang coat hangers or other hard or sharp objects on the hook. If the SRS curtain shield airbags deploy, these items may become projectiles, causing death or serious injury.

6-1. Maintenance and care

Cleaning and protecting the
vehicle exterior**254**

Cleaning and protecting the
vehicle interior**257**

6-2. Maintenance

Maintenance requirements
.....**260**

6-3. Do-it-yourself maintenance

Do-it-yourself service precau-
tions**262**

Hood**264**

Positioning a floor jack.....**265**

Engine compartment**266**

Tires.....**272**

Tire inflation pressure**274**

Wheels.....**275**

Air conditioning filter**276**

Cleaning the hybrid battery
(traction battery) air intake
vents.....**278**

Electronic key battery**281**

Checking and replacing fuses
.....**283**

Light bulbs**285**

Cleaning and protecting the vehicle exterior

Perform cleaning in a manner appropriate to each component and its material.

Cleaning instructions

- Working from top to bottom, liberally apply water to the vehicle body, wheel wells and underside of the vehicle to remove any dirt and dust.
- Wash the vehicle body using a sponge or soft cloth, such as a chamois.
- For hard-to-remove marks, use car wash soap and rinse thoroughly with water.
- Wipe away any water.
- Wax the vehicle when the water-proof coating deteriorates.

If water does not bead on a clean surface, apply wax when the vehicle body is cool.

Automatic car washes

- Fold the mirrors before washing the vehicle. Start washing from the front of the vehicle. Make sure to extend the mirrors before driving.
- Brushes used in automatic car washes may scratch the vehicle surface, parts (wheel, etc.) and harm your vehicle's paint.

High pressure car washes

As water may enter the cabin, do not bring the nozzle tip near the gaps around the doors or perimeter of the

windows, or spray these areas continuously.

When using a car wash

If the door handle becomes wet while the electronic key is within the effective range, the door may lock and unlock repeatedly. In that case, follow the following correction procedures to wash the vehicle:

- Place the key in a position 2 m (6 ft.) or more separate from the vehicle while the vehicle is being washed. (Take care to ensure that the key is not stolen.)
- Set the electronic key to battery-saving mode to disable the smart entry & start system. (→P.112)

Wheels and wheel ornaments

- Remove any dirt immediately by using a neutral detergent.
- Wash detergent off with water immediately after use.
- To protect the paint from damage, make sure to observe the following precautions.
 - Do not use acidic, alkaline or abrasive detergent
 - Do not use hard brushes
 - Do not use detergent on the wheels when they are hot, such as after driving or parking in hot weather

Brake pads and calipers

Rust may form if the vehicle is parked with wet brake pads or disc rotors, causing them to stick. Before parking the vehicle after it is washed, drive slowly and apply the brakes several times to dry the parts.

Bumpers

Do not scrub with abrasive cleaners.

Plated portions

If dirt cannot be removed, clean the parts as follows:

- Use a soft cloth dampened with an approximately 5% solution of neutral detergent and water to clean the dirt off.

- Wipe the surface with a dry, soft cloth to remove any remaining moisture.
- To remove oily deposits, use alcohol wet wipes or a similar product.



WARNING

■ When washing the vehicle

Do not apply water to the inside of the engine compartment. Doing so may cause the electrical components, etc. to catch fire.

■ When cleaning the windshield (vehicles with rain-sensing windshield wipers)

Set the wiper switch to off. If the wiper switch is in "AUTO", the wipers may operate unexpectedly in the following situations, and may result in hands being caught or other serious injuries and cause damage to the wiper blades.

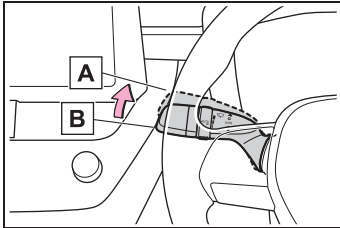

A Off

B AUTO

■ Precautions regarding the exhaust pipe

Exhaust gasses cause the exhaust pipe to become quite hot. When washing the vehicle, be careful not to touch the pipe until it has cooled sufficiently, as touching a hot exhaust pipe can cause burns.

■ Precaution regarding the rear bumper

If the paint of the rear bumper is chipped or scratched, the following systems may not function correctly. If this occurs, consult your Toyota dealer.

- BSM (if equipped)
- RCTA (if equipped)
- SEA (if equipped)



NOTICE

■ To prevent paint deterioration and corrosion on the body and components (aluminum wheels, etc.)

- Wash the vehicle immediately in the following cases:
 - After driving near the sea coast
 - After driving on salted roads
 - If coal tar or tree sap is present on the paint surface
 - If dead insects, insect droppings or bird droppings are present on the paint surface
 - After driving in an area contaminated with soot, oily smoke, mine dust, iron powder or chemical substances
 - If the vehicle becomes heavily soiled with dust or mud
 - If liquids such as benzene and gasoline are spilled on the paint surface
- If the paint is chipped or scratched, have it repaired immediately.
- To prevent the wheels from corroding, remove any dirt and store in a place with low humidity when storing the wheels.



NOTICE

■ Cleaning the exterior lights

- Wash carefully. Do not use organic substances or scrub with a hard brush.

This may damage the surfaces of the lights.

- Do not apply wax to the surfaces of the lights.
Wax may cause damage to the lenses.

■ To prevent damage to the windshield wiper arms

When lifting the wiper arms away from the windshield, pull the driver side wiper arm upward first, and repeat for the passenger side. When returning the wipers to their original position, do so from the passenger side first.

■ When using an automatic car wash (vehicles with rain-sensing windshield wipers)

Set the wiper switch to the off position. If the wiper switch is in "AUTO", the wipers may operate and the wiper blades may be damaged.

■ When using a high pressure car wash

- When washing the vehicle, do not spray the camera or its surrounding area directly with a high pressure washer. Shock applied from high pressure water may cause the device to not operate normally.
- Do not spray water directly on the radar which is equipped behind the emblem. Otherwise it may cause the device to be damaged.

- Do not bring the nozzle tip close to boots (rubber or resin manufactured cover), connectors or the following parts. The parts may be damaged if they come into contact with high-pressure water.

- Traction related parts
- Steering parts
- Suspension parts
- Brake parts

- Keep the cleaning nozzle at least 30 cm (11.9 in.) away from the vehicle body. Otherwise resin section, such as moldings and bumpers, may be deformed and damaged. Also, do not continuously hold the nozzle in the same place.

- Do not spray the lower part of the windshield continuously. If water enters the air conditioning system intake located near the lower part of the windshield, the air conditioning system may not operate correctly.

- Do not wash the underside of the vehicle using a high pressure car washer.

Cleaning and protecting the vehicle interior

Perform cleaning in a manner appropriate to each component and its material.

Protecting the vehicle interior

- Remove dirt and dust using a vacuum cleaner. Wipe dirty surfaces with a cloth dampened with lukewarm water.
- If dirt cannot be removed, wipe it off with a soft cloth dampened with neutral detergent diluted to approximately 1%.
Wring out any excess water from the cloth and thoroughly wipe off remaining traces of detergent and water.

■ Shampooing the carpets

There are several commercial foaming-type cleaners available. Use a sponge or brush to apply the foam. Rub in overlapping circles. Do not use water. Wipe dirty surfaces and let them dry. Excellent results are obtained by keeping the carpet as dry as possible.

■ Handling the seat belts

Clean with mild soap and lukewarm water using a cloth or sponge. Also check the belts periodically for excessive wear, fraying or cuts.



WARNING

■ Water in the vehicle

- Do not splash or spill liquid in the vehicle, such as on the floor, in the hybrid battery (traction battery) air intake vent, and in the trunk. (→P.257)
Doing so may cause the hybrid battery, electrical components, etc. to malfunction or catch fire.
- Do not get any of the SRS components or wiring in the vehicle interior wet. (→P.29)
An electrical malfunction may cause the airbags to deploy or not function properly, resulting in death or serious injury.
- Vehicles with wireless charger: Do not let the wireless charger (→P.245) get wet. Failure to do so may cause the charger to become hot and cause burns or could cause electric shock resulting in death or serious injury.

■ Cleaning the interior (especially instrument panel)

Do not use polish wax or polish cleaner. The instrument panel may reflect off the windshield, obstructing the driver's view and leading to an accident, resulting in death or serious injury.



NOTICE

■ Cleaning detergents

- Do not use the following types of detergent, as they may discolor the vehicle interior or cause streaks or damage to painted surfaces:
 - Areas other than the seats and steering wheel: Organic substances such as benzene or gasoline, alkaline or acidic solutions, dye, and bleach

**NOTICE**

- Seats: Alkaline or acidic solutions, such as thinner, benzene, and alcohol
- Steering wheel: Organic substances, such as thinner, and cleaner that contains alcohol
- Do not use polish wax or polish cleaner. The instrument panel's or other interior part's painted surface may be damaged.

■ Preventing damage to leather surfaces

Observe the following precautions to avoid damage to and deterioration of leather surfaces:

- Remove any dust or dirt from leather surfaces immediately.
- Do not expose the vehicle to direct sunlight for extended periods of time. Park the vehicle in the shade, especially during summer.
- Do not place items made of vinyl, plastic, or containing wax on the upholstery, as they may stick to the leather surface if the vehicle interior heats up significantly.

■ Water on the floor

Do not wash the vehicle floor with water.

Vehicle systems such as the audio system may be damaged if water comes into contact with electrical components such as the audio system above or under the floor of the vehicle. Water may also cause the body to rust.

■ When cleaning the inside of the windshield

Do not allow glass cleaner to contact the lens. Also, do not touch the lens. (→P.166)

■ Cleaning the inside of the rear window

- Do not use glass cleaner to clean the rear window, as this may cause damage to the rear window defogger heater wires or antenna. Use a cloth dampened with lukewarm water to gently wipe the window clean. Wipe the window in strokes running parallel to the heater wires or antenna.
- Be careful not to scratch or damage the heater wires or antenna.

Cleaning the areas with satin-finish metal accents

- Remove dirt using a water-dampened soft cloth or synthetic chamois.
- Wipe the surface with a dry, soft cloth to remove any remaining moisture.

■ Cleaning the areas with satin-finish metal accents

The metal areas use a layer of real metal for the surface. It is necessary to clean them regularly. If dirty areas are left uncleaned for long periods of time, they may be difficult to clean.

Cleaning the leather areas

- Remove dirt and dust using a vacuum cleaner.
- Wipe off any excess dirt and dust with a soft cloth dampened with diluted detergent.

Use a diluted water solution of approximately 5% neutral wool detergent.

- Wring out any excess water from

the cloth and thoroughly wipe off all remaining traces of detergent.

- Wipe the surface with a dry, soft cloth to remove any remaining moisture. Allow the leather to dry in a shaded and ventilated area.

■ Caring for leather areas

Toyota recommends cleaning the interior of the vehicle at least twice a year to maintain the quality of the vehicle's interior.

Cleaning the synthetic leather areas

- Remove dirt and dust using a vacuum cleaner.
- Wipe it off with a soft cloth dampened with neutral detergent diluted to approximately 1%.
- Wring out any excess water from the cloth and thoroughly wipe off remaining traces of detergent and water.

Maintenance requirements

To ensure safe and economical driving, day-to-day care and regular maintenance are essential. Toyota recommends the maintenance below.

■ Where to go for maintenance service?

It makes good sense to take your vehicle to your local Toyota dealer for maintenance service as well as other inspections and repairs.

Toyota technicians are well-trained specialists receiving the latest service information through technical bulletins, service tips, and in-dealership training programs. They learn to work on Toyota before they work on your vehicle, rather than while they are working on it. Doesn't that seem like the best way?

Your Toyota dealer has invested a lot of money in special Toyota tools and service equipment. It helps them to do the job better and at less cost.

Your Toyota dealer's service department will perform all of the scheduled maintenance on your vehicle reliably and economically.



WARNING

■ If your vehicle is not properly maintained

Improper maintenance could result in serious damage to the vehicle and possible death or serious injury.

■ Handling of the 12-volt battery

12-volt battery posts, terminals and related accessories contain lead and lead compounds which are known to cause brain damage. Wash your hands after handling. (→P.269)

Scheduled maintenance

Scheduled maintenance should be performed at specified intervals according to the maintenance schedule.

For full details of your maintenance schedule, refer to the "Warranty and Service Booklet".

Do-it-yourself maintenance

What about do-it-yourself maintenance?

Many of the maintenance items are easy to do yourself if you have a little mechanical ability and a few basic automotive tools.

Note, however, that some maintenance tasks require special tools and skills. These are best performed by qualified technicians. Even if you are an experienced do-it-yourself mechanic, we recommend that repairs and maintenance be conducted by your Toyota dealer who will keep a record of maintenance on your vehicle. This record could be helpful should you ever require Warranty Service.

■ Does your vehicle need repairs?

Be on the alert for changes in performance and sounds, and visual tip-offs that indicate service is needed. Some important clues are:

- Engine missing, stumbling or pinging
- Appreciable loss of power
- Strange engine noises
- A fluid leak under the vehicle (However, water dripping from the air conditioning system after use is normal.)
- Change in exhaust sound (This may

indicate a dangerous carbon monoxide leak. Drive with the windows open and have the exhaust system checked immediately.)

- Flat-looking tires, excessive tire squeal when cornering, uneven tire wear
- Vehicle pulls to one side when driven straight on a level road
- Strange noises related to suspension movement
- Loss of brake effectiveness, spongy feeling brake pedal, pedal almost touches the floor, vehicle pulls to one side when braking
- Engine coolant temperature continually higher than normal (→P.72, 75)

If you notice any of these clues, take your vehicle to your Toyota dealer as soon as possible. Your vehicle may need adjustment or repair.

Do-it-yourself service precautions

If you perform maintenance by yourself, be sure to follow the correct procedure as given in these sections.

Maintenance

Items	Parts and tools
12-volt battery condition (→P.269)	<ul style="list-style-type: none"> • Warm water • Baking soda • Grease • Conventional wrench (for terminal clamp bolts) • Distilled water
Engine/power control unit coolant level (→P.268)	<ul style="list-style-type: none"> • “Toyota Super Long Life Coolant” or a similar high quality ethylene glycol-based non-silicate, non-amine, non-nitrite and non-borate coolant with long-life hybrid organic acid technology • “Toyota Super Long Life Coolant” is pre-mixed with 50% coolant and 50% deionized water. • Funnel (used only for adding coolant)
Engine oil level (→P.266)	<ul style="list-style-type: none"> • “Toyota Genuine Motor Oil” or equivalent • Rag or paper towel • Funnel (used only for adding engine oil)

Items	Parts and tools
Fuses (→P.283)	<ul style="list-style-type: none"> • Fuse with same amperage rating as original
Hybrid battery (traction battery) air intake vent (→P.278)	<ul style="list-style-type: none"> • Vacuum cleaner, etc.
Light bulbs (→P.285)	<ul style="list-style-type: none"> • Bulb with same number and wattage rating as original • Flathead screwdriver • Wrench
Radiator and condenser (→P.269)	—
Tire inflation pressure (→P.274)	<ul style="list-style-type: none"> • Tire pressure gauge • Compressed air source
Washer fluid (→P.271)	<ul style="list-style-type: none"> • Water or washer fluid containing antifreeze (for winter use) • Funnel (used only for adding water or washer fluid)



WARNING

The engine compartment contains many mechanisms and fluids that may move suddenly, become hot, or become electrically energized. To avoid death or serious injury, observe the following precautions.

■ When working on the engine compartment

- Make sure that the “ACCESSORY” or “IGNITION ON” on the multi-information display and the “READY” indicator are both off.

**WARNING**

- Keep hands, clothing and tools away from the moving fans.
- Be careful not to touch the engine, power control unit, radiator, exhaust manifold, etc. right after driving as they may be hot. Oil and other fluids may also be hot.
- Do not leave anything that may burn easily, such as paper and rags, in the engine compartment.
- Do not smoke, cause sparks or expose an open flame to fuel or the 12-volt battery. Fuel and 12-volt battery fumes are flammable.
- Be extremely cautious when working on the 12-volt battery. It contains poisonous and corrosive sulfuric acid.
- Take care because brake fluid can harm your hands or eyes and damage painted surfaces. If fluid gets on your hands or in your eyes, flush the affected area with clean water immediately.
If you still experience discomfort, consult a doctor.

■ **When working near the electric cooling fans or radiator grille**

Be sure the power switch is OFF. With the power switch in ON, the electric cooling fans may automatically start to run if the air conditioning is on and/or the coolant temperature is high. (→P.269)

■ **Safety glasses**

Wear safety glasses to prevent flying or falling material, fluid spray, etc. from getting in your eyes.

**NOTICE**

■ **If you remove the air cleaner filter**

Driving with the air cleaner filter removed may cause excessive engine wear due to dirt in the air.

■ **If the fluid level is low or high**

It is normal for the brake fluid level to go down slightly as the brake pads wear or when the fluid level in the accumulator is high.

If the reservoir needs frequent refilling, it may indicate a serious problem.

Hood

Opening the hood

- 1 Pull the hood lock release lever.

The hood will pop up slightly.

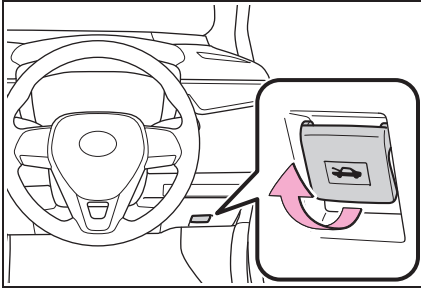

- 2 Pull the auxiliary catch lever to the left and lift the hood.

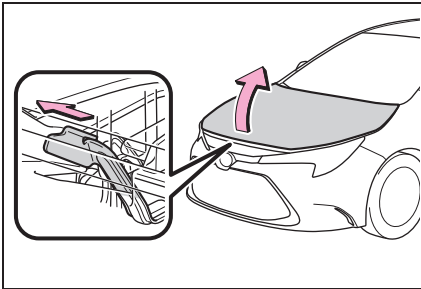

- 3 Hold the hood open by inserting the support rod into the slot.

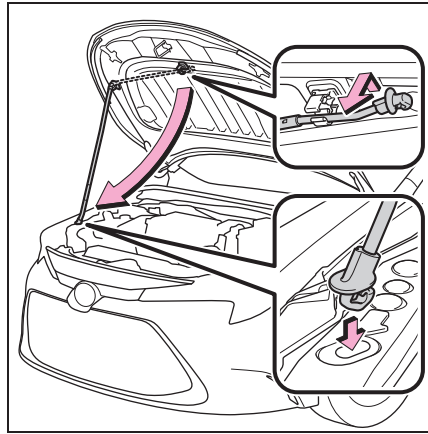

⚠ WARNING

■ Pre-driving check

Check that the hood is fully closed and locked.

If the hood is not locked properly, it may open while the vehicle is in motion and cause an accident, which may result in death or serious injury.

■ After installing the support rod into the slot

Make sure the rod supports the hood securely preventing it from falling down onto your head or body.

⚠ NOTICE

■ When closing the hood

Be sure to return the support rod to its clip before closing the hood. Closing the hood with the support rod not clipped could cause the hood to bend.

Positioning a floor jack

When using a floor jack, follow the instructions in the manual provided with the jack and perform the operation safely.

When raising your vehicle with a floor jack, position the jack correctly. Improper placement may damage your vehicle or cause injury.

Location of the jack point

■ Front

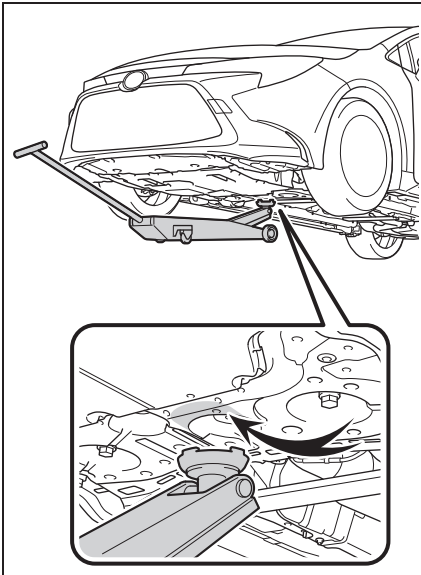

■ Rear

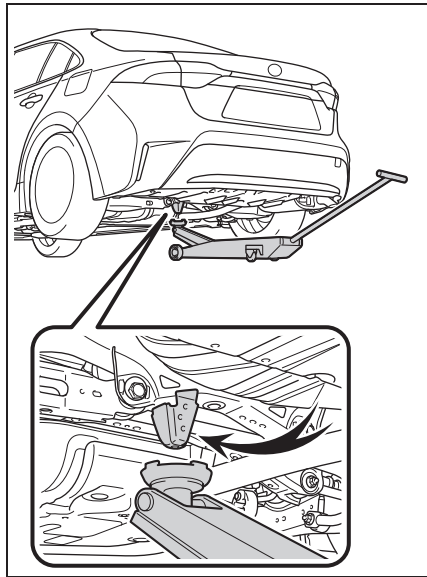

Engine compartment

Components

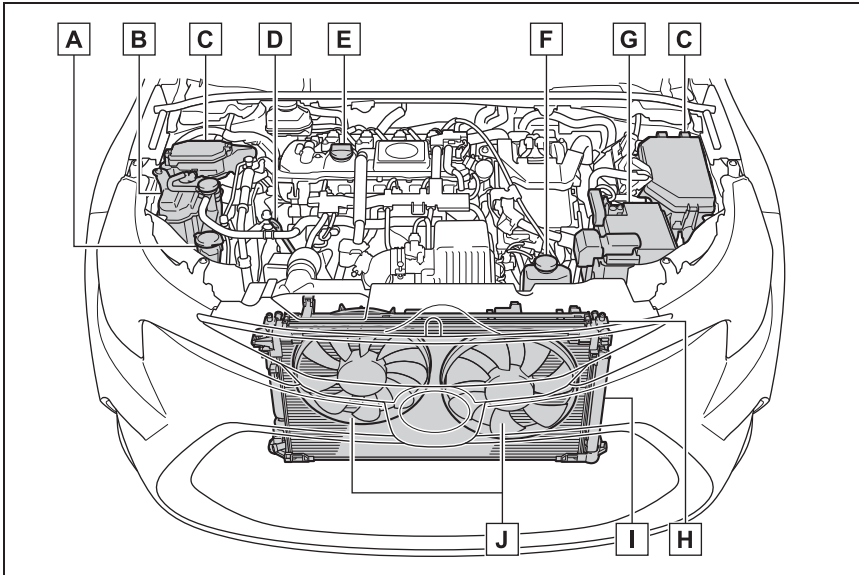

- A** Washer fluid tank (→P.271)
- B** Engine coolant reservoir (→P.268)
- C** Fuse boxes (→P.283)
- D** Engine oil level dipstick (→P.266)
- E** Engine oil filler cap (→P.267)
- F** Power control unit coolant reservoir (→P.268)
- G** 12-volt battery (→P.269)
- H** Radiator (→P.269)
- I** Condenser (→P.269)
- J** Electric cooling fans

Checking and adding the engine oil

With the engine at operating temperature and turned off, check the

oil level on the dipstick.

■ Checking the engine oil

- 1** Park the vehicle on level ground. After warming up the

engine and turning off the hybrid system, wait more than 5 minutes for the oil to drain back into the bottom of the engine.

- 2 Holding a rag under the end, pull the dipstick out.

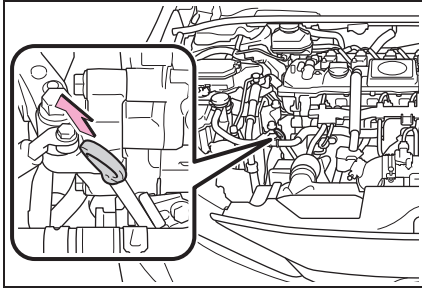

- 3 Wipe the dipstick clean.
- 4 Reinsert the dipstick fully.
- 5 Holding a rag under the end, pull the dipstick out and check the oil level.

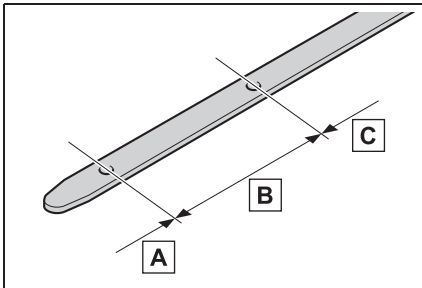

- A** Low
- B** Normal
- C** Excessive

The shape of the dipstick may differ depending on the type of vehicle or engine.

- 6 Wipe the dipstick and reinsert it fully.

■ Checking the oil type and preparing the item needed

Make sure to check the oil type and prepare the items needed before adding oil.

- Engine oil selection
→P.339
- Oil quantity (Low → Full)
1.5 L (1.6 qt., 1.3 Imp. qt.)
- Item
Clean funnel

■ Adding engine oil

If the oil level is below or near the low level mark, add engine oil of the same type as that already in the engine.

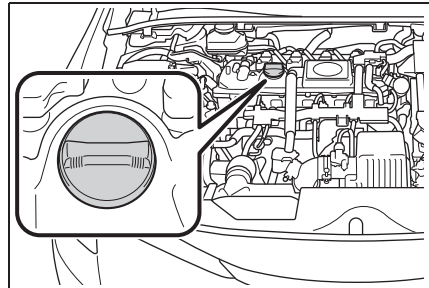

- 1 Remove the oil filler cap by turning it counterclockwise.
- 2 Add engine oil slowly, checking the dipstick.
- 3 Install the oil filler cap by turning it clockwise.

■ Engine oil consumption

A certain amount of engine oil will be consumed while driving. In the following situations, oil consumption may increase, and engine oil may need to be refilled in between oil maintenance intervals.

- When the engine is new, for example directly after purchasing the vehicle or after replacing the engine
- If low quality oil or oil of an inappropriate viscosity is used
- When driving at high engine speeds or with a heavy load, or when driving while accelerating or decelerating frequently
- When leaving the engine idling for a long time, or when driving frequently through heavy traffic



WARNING

■ Used engine oil

- Used engine oil contains potentially harmful contaminants which may cause skin disorders such as inflammation and skin cancer, so care should be taken to avoid prolonged and repeated contact. To remove used engine oil from your skin, wash thoroughly with soap and water.
- Dispose of used oil and filters only in a safe and acceptable manner. Do not dispose of used oil and filters in household trash, in sewers or onto the ground. Call your Toyota dealer, service station or auto parts store for information concerning recycling or disposal.
- Do not leave used engine oil within the reach of children.



NOTICE

■ To prevent serious engine damage

Check the oil level on a regular basis.

■ When replacing the engine oil

- Be careful not to spill engine oil on the vehicle components.

- Avoid overfilling, or the engine could be damaged.
- Check the oil level on the dipstick every time you refill the vehicle.
- Be sure the engine oil filler cap is properly tightened.

Checking the coolant

■ Engine coolant reservoir

The coolant level is satisfactory if it is between the “MAX” and “MIN” lines on the reservoir when the engine is cold.

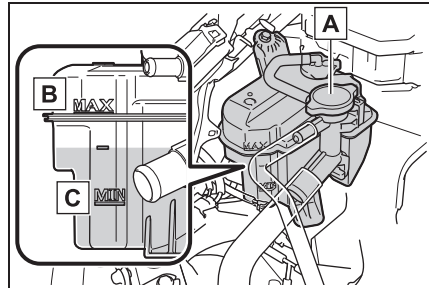

- A** Reservoir
- B** “MAX” line
- C** “MIN” line

If the level is on or below the “MIN” line, add coolant up to the “MAX” line. (→P.333)

■ Power control unit coolant reservoir

The coolant level is satisfactory if it is between the “MAX” and “MIN” lines on the reservoir when the hybrid system is cold.

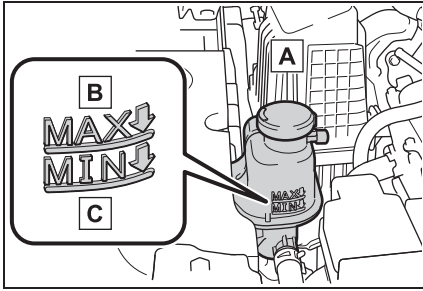

A Reservoir

B “MAX” line

C “MIN” line

If the level is on or below the “MIN” line, add coolant up to the “MAX” line. (→P.333)

■ Coolant selection

Only use “Toyota Super Long Life Coolant” or a similar high quality ethylene glycol based non-silicate, non-amine, non-nitrite, and non-borate coolant with long-life hybrid organic acid technology.

“Toyota Super Long Life Coolant” is a mixture of 50% coolant and 50% deionized water. (Minimum temperature: -35°C [-31°F])

For more details about coolant, contact your Toyota dealer.

■ If the coolant level drops within a short time of replenishing

Visually check the radiator, hoses, engine/power control unit coolant reservoir caps, drain cock and water pump. If you cannot find a leak, have your Toyota dealer test the cap and check for leaks in the cooling system.

⚠ WARNING

■ When the hybrid system is hot

Do not remove the engine/power control unit coolant reservoir caps.

The cooling system may be under pressure and may spray hot coolant if the cap is removed, causing serious injuries, such as burns.

⚠ NOTICE

■ When adding coolant

Coolant is neither plain water nor straight antifreeze. The correct mixture of water and antifreeze must be used to provide proper lubrication, corrosion protection and cooling. Be sure to read the antifreeze or coolant label.

■ If you spill coolant

Be sure to wash it off with water to prevent it from damaging parts or paint.

Checking the radiator and condenser

Check the radiator and condenser and clear away any foreign objects. If either of the above parts is extremely dirty or you are not sure of their condition, have your vehicle inspected by your Toyota dealer.

⚠ WARNING

■ When the hybrid system is hot

Do not touch the radiator or condenser as they may be hot and cause serious injuries, such as burns.

12-volt battery

Check the 12-volt battery as fol-

lows.

■ 12-volt battery exterior

Make sure that the 12-volt battery terminals are not corroded and that there are no loose connections, cracks, or loose clamps.

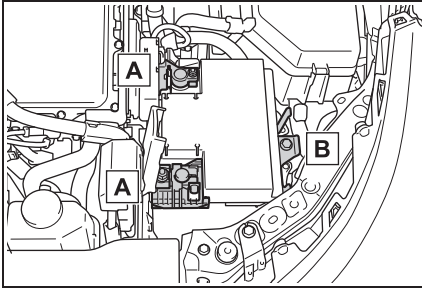

A Terminals

B Hold-down clamp

■ Before recharging

When recharging, the 12-volt battery produces hydrogen gas which is flammable and explosive. Therefore, observe the following precautions before recharging:

- If recharging with the 12-volt battery installed on the vehicle, be sure to disconnect the ground cable.
- Make sure the charger is off when connecting and disconnecting the charger cables to the 12-volt battery.

■ After recharging/reconnecting the 12-volt battery

- Unlocking the doors using the smart entry & start system may not be possible immediately after reconnecting the 12-volt battery. If this happens, use the wireless remote control or the mechanical key to lock/unlock the doors.
- Start the hybrid system with the power switch in ACC. The hybrid system may not start with the power switch turned off. However, the hybrid sys-

tem will operate normally from the second attempt.

- The power switch mode is recorded by the vehicle. If the 12-volt battery is reconnected, the vehicle will return the power switch mode to the status it was in before the 12-volt battery was disconnected. Make sure to turn off the power before disconnecting the 12-volt battery. Take extra care when connecting the 12-volt battery if the power switch mode prior to discharge is unknown.

If the system will not start even after multiple attempts, contact your Toyota dealer.

⚠ WARNING

■ Chemicals in the 12-volt battery

The 12-volt battery contains poisonous and corrosive sulfuric acid and may produce hydrogen gas which is flammable and explosive. To reduce the risk of death or serious injury, take the following precautions while working on or near the 12-volt battery:

- Do not cause sparks by touching the 12-volt battery terminals with tools.
- Do not smoke or light a match near the 12-volt battery.
- Avoid contact with eyes, skin and clothes.
- Never inhale or swallow electrolyte.
- Wear protective safety glasses when working near the 12-volt battery.
- Keep children away from the 12-volt battery.

**WARNING**

■ **Where to safely charge the 12-volt battery**

Always charge the 12-volt battery in an open area. Do not charge the 12-volt battery in a garage or closed room where there is insufficient ventilation.

■ **Emergency measures regarding electrolyte**

- If electrolyte gets in your eyes
Flush your eyes with clean water for at least 15 minutes and get immediate medical attention. If possible, continue to apply water with a sponge or cloth while traveling to the nearest medical facility.
- If electrolyte gets on your skin
Wash the affected area thoroughly. If you feel pain or burning, get medical attention immediately.
- If electrolyte gets on your clothes
It can soak through clothing on to your skin. Immediately take off the clothing and follow the procedure above if necessary.
- If you accidentally swallow electrolyte
Drink a large quantity of water or milk. Get emergency medical attention immediately.

■ **When disconnecting the 12-volt battery**

Do not disconnect the negative (-) terminal on the body side. The disconnected negative (-) terminal may touch the positive (+) terminal, which may cause a short and result in death or serious injury.

**NOTICE**

■ **When recharging the 12-volt battery**

Never recharge the 12-volt battery while the hybrid system is operating. Also, be sure all accessories are turned off.

Adding the washer fluid

If the washer fluid level is at “LOW”, add washer fluid.

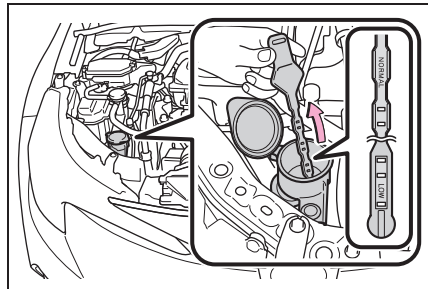

■ **Using the gauge**

The washer fluid level can be checked by observing the position of the level on the liquid-covered holes in the gauge. If the level falls below the second hole from the bottom (the “LOW” position), refill the washer fluid.

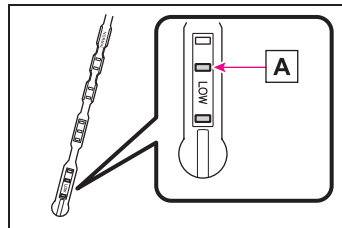

A Current fluid level

**WARNING**

■ **When adding washer fluid**

Do not add washer fluid when the hybrid system is hot or operating as washer fluid contains alcohol and may catch fire if spilled on the engine, etc.

**NOTICE**

■ **Do not use any fluid other than washer fluid**

Do not use soapy water or engine antifreeze instead of washer fluid. Doing so may cause streaking on the vehicle's painted surfaces, as well as damaging the pump leading to problems of the washer fluid not spraying.

■ **Diluting washer fluid**

Dilute washer fluid with water as necessary. Refer to the freezing temperatures listed on the label of the washer fluid bottle.

Tires

Replace or rotate tires in accordance with maintenance schedules and treadwear.

Checking tires

Check if the treadwear indicators are showing on the tires. Also check the tires for uneven wear, such as excessive wear on one side of the tread.

Check the spare tire condition and pressure if not rotated.

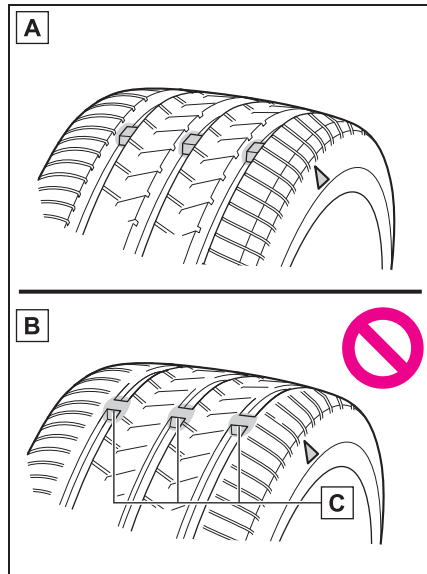

A New tread

B Worn tread

C Treadwear indicator

The location of treadwear indicators is shown by a “TWI” or “ \triangle ” mark, etc., molded into the sidewall of each tire.

Replace the tires if the treadwear indicators are showing on a tire.

■ When to replace your vehicle's tires

Tires should be replaced if:

- The treadwear indicators are showing on a tire
- You have tire damage such as cuts, splits, cracks deep enough to expose the fabric, and bulges indicating internal damage
- A tire goes flat repeatedly or cannot be properly repaired due to the size or location of a cut or other damage

If you are not sure, consult with your Toyota dealer.

■ Tire life

Any tire over 6 years old must be checked by a qualified technician even if it has seldom or never been used or damage is not obvious.

■ Low profile tires (18-inch tires)

Generally, low profile tires will wear more rapidly and tire grip performance will be reduced on snowy and/or icy roads when compared to standard tires. Be sure to use snow tires or tire chains on snowy and/or icy roads and drive carefully at a speed appropriate for road and weather conditions.

■ If the tread on snow tires wears down below 4 mm (0.16 in.)

The effectiveness of the tires as snow tires is lost.

■ Checking the tire valves

When replacing the tires, check the tire valves for deformation, cracks, and other damage.



WARNING

■ When inspecting or replacing tires

Observe the following precautions to prevent accidents.

Failure to do so may cause damage to parts of the drive train as well as dangerous handling characteristics, which may lead to an accident resulting in death or serious injury.

- Do not mix tires of different makes, models or tread patterns. Also, do not mix tires of remarkably different treadwear.
- Do not use tire sizes other than those recommended by Toyota.
- Do not mix differently constructed tires (radial, bias-belted or bias-ply tires).
- Do not mix summer, all season and snow tires.
- Do not use tires that have been used on another vehicle. Do not use tires if you do not know how they were used previously.



NOTICE

■ Low profile tires (18-inch tires)

Low profile tires may cause greater damage than usual to the tire wheel when sustaining impact from the road surface. Therefore, pay attention to the following:

- Be sure to use proper tire inflation pressure. If tires are under-inflated, they may be damaged more severely.
- Avoid potholes, uneven pavement, curbs and other road hazards. Failure to do so may lead to severe tire and wheel damage.

**NOTICE**

■ **If tire inflation pressure of each tire becomes low while driving**

Do not continue driving, or your tires and/or wheels may be ruined.

■ **Driving on rough roads**

Take particular care when driving on roads with loose surfaces or potholes. These conditions may cause losses in tire inflation pressure, reducing the cushioning ability of the tires. In addition, driving on rough roads may cause damage to the tires themselves, as well as the vehicle's wheels and body.

Tire rotation

Rotate the tires in the order shown.

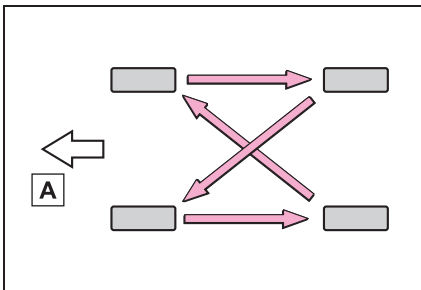

A Front

To equalize tire wear and help extend tire life, Toyota recommends that tire rotation is carried out approximately every 10000 km (6000 miles).

Tire inflation pressure

Make sure to maintain proper tire inflation pressure. Tire inflation pressure should be checked at least once per month. However, Toyota recommends that tire inflation pressure be checked once every two weeks. (→P.343)

■ **Effects of incorrect tire inflation pressure**

Driving with incorrect tire inflation pressure may result in the following:

- Reduced fuel economy
- Reduced driving comfort and poor handling
- Reduced tire life due to wear
- Reduced safety
- Damage to the drive train

If a tire needs frequent inflating, have it checked by your Toyota dealer.

■ **Instructions for checking tire inflation pressure**

When checking tire inflation pressure, observe the following:

- Check only when the tires are cold. If your vehicle has been parked for at least 3 hours or has not been driven for more than 1.5 km or 1 mile, you will get an accurate cold tire inflation pressure reading.
- Always use a tire pressure gauge. It is difficult to judge if a tire is properly inflated based only on its appearance.
- It is normal for the tire inflation pressure to be higher after driving as heat is generated in the tire. Do not reduce tire inflation pressure after driving.
- Passengers and luggage weight should be placed so that the vehicle is balanced.

**WARNING****■ Proper inflation is critical to save tire performance**

Keep your tires properly inflated. If the tires are not properly inflated, the following conditions may occur which could lead to an accident resulting in death or serious injury:

- Excessive wear
- Uneven wear
- Poor handling
- Possibility of blowouts resulting from overheated tires
- Air leaking from between tire and wheel
- Wheel deformation and/or tire damage
- Greater possibility of tire damage while driving (due to road hazards, expansion joints, sharp edges in the road, etc.)

**NOTICE****■ When inspecting and adjusting tire inflation pressure**

Be sure to put the tire valve caps back on.

If a valve cap is not installed, dirt or moisture may get into the valve and cause an air leak, resulting in decreased tire inflation pressure.

Wheels

If a wheel is bent, cracked or heavily corroded, it should be replaced. Otherwise, the tire may separate from the wheel or cause a loss of handling control.

Wheel selection

When replacing wheels, care should be taken to ensure that they are equivalent to those removed in load capacity, diameter, rim width and inset*.

Replacement wheels are available at your Toyota dealer.

*: Conventionally referred to as offset.

Toyota does not recommend using the following:

- Wheels of different sizes or types
- Used wheels
- Bent wheels that have been straightened

**WARNING****■ When replacing wheels**

- Do not use wheels that are a different size from those recommended in the Owner's Manual, as this may result in a loss of handling control.
- Never use an inner tube in a leaking wheel which is designed for a tubeless tire. Doing so may result in an accident, causing death or serious injury.

**WARNING**

■ **When installing the wheel nuts**

Never use oil or grease on the wheel bolts or wheel nuts.

Oil and grease may cause the wheel nuts to be excessively tightened, leading to bolt or disc wheel damage. In addition, the oil or grease can cause the wheel nuts to loosen and the wheel may fall off, causing an accident and resulting in death or serious injury. Remove any oil or grease from the wheel bolts or wheel nuts.

■ **Use of defective wheels prohibited**

Do not use cracked or deformed wheels. Doing so could cause the tire to leak air during driving, possibly causing an accident.

Aluminum wheel precautions

- Use only Toyota wheel nuts and wheel nut wrenches designed for use with your aluminum wheels.
- When rotating, repairing or changing your tires, check that the wheel nuts are still tight after driving 1600 km (1000 miles).
- Be careful not to damage the aluminum wheels when using tire chains.
- Use only Toyota genuine balance weights or equivalent and a plastic or rubber hammer when balancing your wheels.

Air conditioning filter

The air conditioning filter must be changed regularly to maintain air conditioning efficiency.

Removing the air conditioning filter

- 1 Turn the power switch off.
- 2 Open the glove box. Slide off the damper.

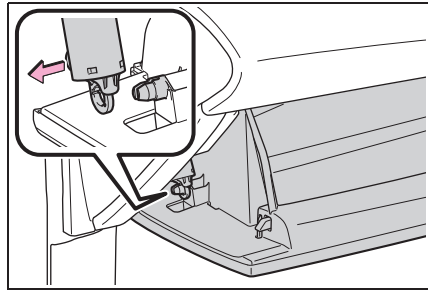

- 3 Push in the glove box on the vehicle's outer side to disconnect the claws. Then pull out the glove box and disconnect the lower claws.

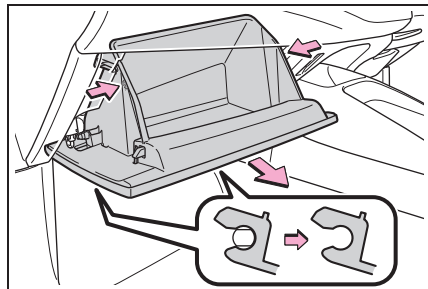

- 4 Unlock the filter cover (A), pull the filter cover out of the claws

(B), and remove the filter cover.

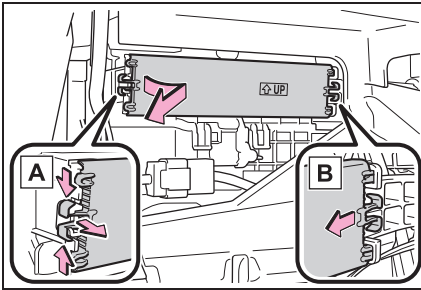

5 Remove the filter case.

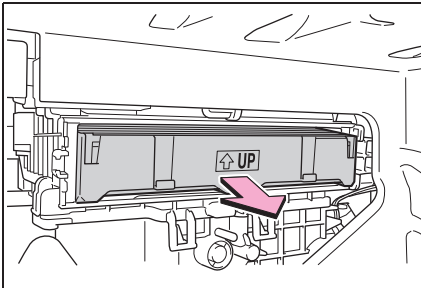

6 Remove the air conditioning filter from the filter case and replace it with a new one.

The “↑ UP” marks shown on the filter and the filter case should be pointing up.

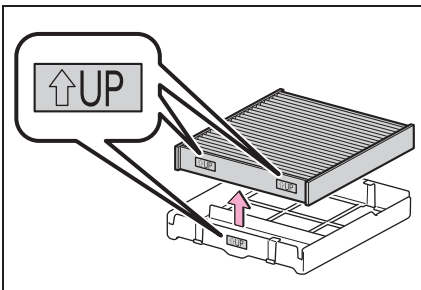

■ Checking interval

Inspect and replace the air conditioning filter according to the maintenance schedule. In dusty areas or areas with

heavy traffic flow, early replacement may be required. (For scheduled maintenance information, please refer to the “Warranty and Service Booklet”.)

■ If air flow from the vents decreases dramatically

The filter may be clogged. Check the filter and replace if necessary.

⚠ NOTICE

■ When using the air conditioning system

Make sure that a filter is always installed.

Using the air conditioning system without a filter may cause damage to the system.

■ To prevent damage to the filter cover

When moving the filter cover in the direction of arrow to release the fitting, pay attention not to apply excessive force to the claws. Otherwise, the claws may be damaged.

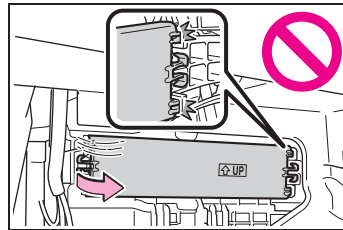

Cleaning the hybrid battery (traction battery) air intake vents

To prevent the fuel economy from being affected, visually inspect the hybrid battery (traction battery) air intake vents periodically for clogs. If it is dusty or clogged or if “Maintenance Required for Traction Battery Cooling Parts See Owner’s Manual” is displayed on the multi-information display, clean the air intake vent using the following procedures:

■ Checking interval

In some situations such as when the vehicle is used frequently or in heavy traffic or dusty areas, the air intake vent may need to be cleaned more regularly. For scheduled maintenance information, please refer to the “Warranty and Service Booklet”.

■ Cleaning the air intake vent

Improper handling of the air intake vent cover and filter may result in damage to them. If you have any concerns about cleaning the filter, contact your Toyota dealer.

⚠ NOTICE

- If “Maintenance Required for Traction Battery Cooling Parts See Owner’s Manual” is displayed on the multi-information display

Clean the air intake vent immediately. If the vehicle is continuously driven with the warning message displayed, it may cause a malfunction or output restriction of the hybrid battery (traction battery).

Cleaning procedure

- 1 Turn the power switch off.
- 2 Remove the air intake vent cover.

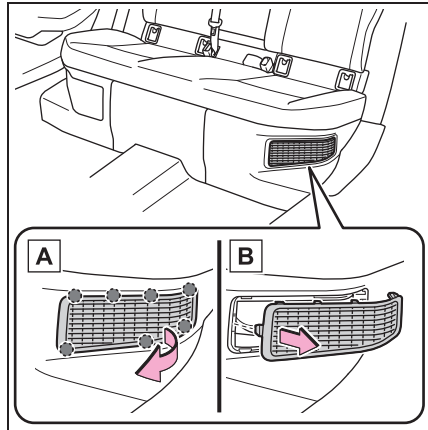

- A Pull the cover as shown in the illustration to disengage the 7 claws, starting from the claw in the upper right corner.
- B Pull the cover toward the front of the vehicle to remove it.

- 3** Remove the filter from the air intake vent cover.

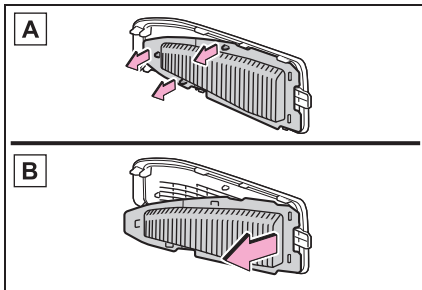

A Disengage the claw as shown in the illustration.

B Remove the filter from the cover. If dust has accumulated on the air intake vent cover, remove the dust with a vacuum cleaner, etc.

- 4** Remove the dust and sand from the filter.

Using a vacuum cleaner, etc., absorb dust and sand from the filter by profiling the nozzle lightly along the fold.

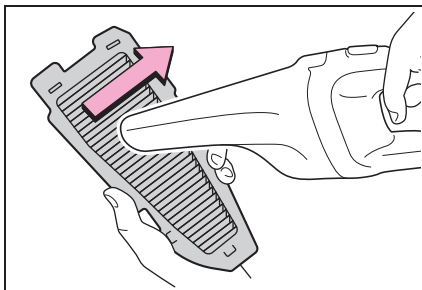

- 5** Hold the filter to the light and check if it is not clogged.

If the dust or sand cannot be removed

completely, contact your Toyota dealer.

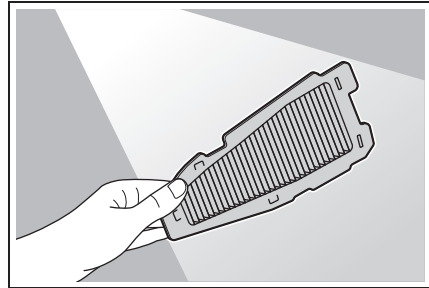

- 6** Install the filter in its original position, and then install the air intake vent cover.

▶ If “Maintenance Required for Traction Battery Cooling Parts See Owner’s Manual” is displayed on the multi-information display

- 7** Start the hybrid system and check that the warning message is no longer displayed.

It may be necessary to drive the vehicle for warning message is displayed again then disappears.

If the warning message does not disappear after some time, have the vehicle inspected by your Toyota dealer.

■ **If the dust or sand on the filter cannot be removed**

It is recommended to use a vacuum cleaner with plastic brushes.

⚠ WARNING

■ **When cleaning the air intake vent**

- Do not use water or other liquids to clean the air intake vent. If water is applied to the hybrid battery (traction battery) or other components, a malfunction or fire may occur.

**WARNING**

- Before cleaning the air intake vent, make sure to turn the power switch off to stop the hybrid system.
- Do not put a hand or leg in the air intake vent. If it is caught in a cooling fan, or if it touches a high voltage part that results in an electric shock, death or serious injuries may result.

- Do not press hard a vacuum cleaner, etc. against the filter.
- Do not use a hard brush, such as a metal brush.
- Do not break the fold of the filter.

**NOTICE****■ When cleaning the air intake vent**

Do not use an air blow gun, etc.

Dust may be blown out, possibly causing a malfunction or output restriction of the hybrid battery (traction battery).

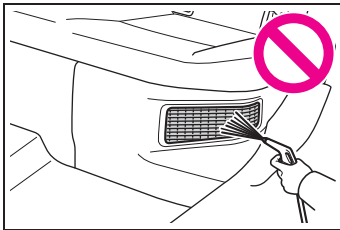
**■ To prevent damage to the vehicle**

Observe the following precautions:

- Do not allow liquid or foreign material to enter the air intake vent.
- Make sure to reinstall the filter and cover to their original positions after cleaning.
- Do not install anything to the air intake vent other than the exclusive filter for this vehicle or use the vehicle without the filter installed.

■ To prevent damage to the filter

Observe the following precautions. If the filter is damaged, have it replaced with a new filter by your Toyota dealer.

- Do not use an air blow gun, etc.

Electronic key battery

Replace the battery with a new one if it is depleted.

As the key may be damaged if the following procedure is not performed properly, it is recommended that key battery replacement be performed by your Toyota dealer.

■ If the electronic key battery is depleted

The following symptoms may occur:

- The smart entry & start system and wireless remote control will not function properly.
- The operational range will be reduced.

Items to prepare

- Flathead screwdriver
- Small flathead screwdriver
- Lithium battery CR2450

■ Use a CR2450 lithium battery

- Batteries can be purchased at your Toyota dealer, local electrical appliance shops or camera stores.
- Replace only with the same or equivalent type recommended by the manufacturer.
- Dispose of used batteries according to local laws.

Replacing the battery

- 1 Release the lock and remove the mechanical key.

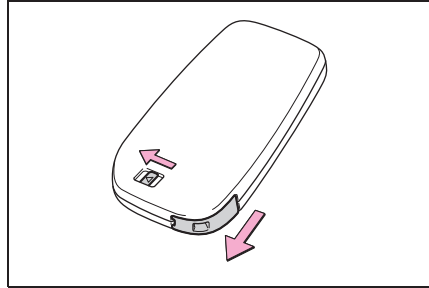

- 2 Remove the key cover.

To prevent damage to the key, cover the tip of the flathead screwdriver with a rag.

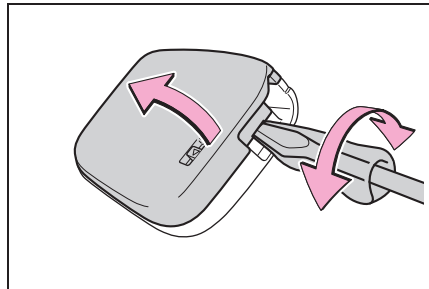



- 3 Remove the depleted battery using a small flathead screwdriver.

When removing the cover, the electronic key module may stick to the cover and the battery may not be visible. In this case, remove the electronic key module in order to remove the battery.

Insert a new battery with the “+” termi-

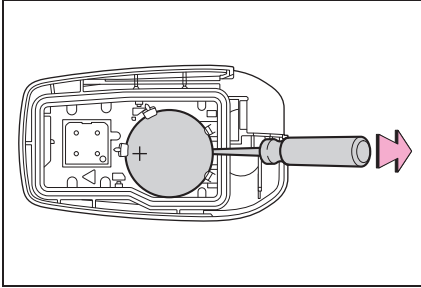
nal facing up.



- 4 When installing the key cover and mechanical key, install by conducting step 2 and step 1 with the directions reversed.
- 5 Operate the  or  switch and check that the doors can be locked/unlocked.



WARNING

■ Battery precautions

Observe the following precautions. Failure to do so may result in death or serious injury.

- Do not swallow the battery. Doing so may cause chemical burns.
- A coin battery or button battery is used in the electronic key. If a battery is swallowed, it may cause severe chemical burns in as little as 2 hours and may result in death or serious injury.
- Keep away new and removed batteries from children.
- If the cover cannot be firmly closed, stop using the electronic key and stow the key in the place where children cannot reach, and then contact your Toyota dealer.
- If you accidentally swallow a battery or put a battery into a part of your body, get emergency medical attention immediately.

■ To prevent battery explosion or leakage of flammable liquid or gas

- Replace the battery with a new battery of the same type. If a wrong type of battery is used, it may explode.
- Do not expose batteries to extremely low pressure due to high altitude or extremely high temperatures.
- Do not burn, break or cut a battery.



NOTICE

■ When replacing the battery

Use a flathead screwdriver of appropriate size. Applying excessive force may deform or damage the cover.

■ For normal operation after replacing the battery

Observe the following precautions to prevent accidents:

- Always work with dry hands. Moisture may cause the battery to rust.
- Do not touch or move any other component inside the remote control.
- Do not bend either of the battery terminals.

Checking and replacing fuses

If any of the electrical components do not operate, a fuse may have blown. If this happens, check and replace the fuses as necessary.

Checking and replacing fuses

- 1 Turn the power switch off.
- 2 Open the fuse box cover.
- ▶ Engine compartment: type A fuse box

Push the tabs in and lift the lid off.

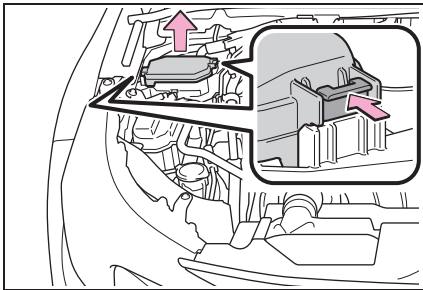

- ▶ Engine compartment: type B fuse box

Push the tabs in and lift the lid off.

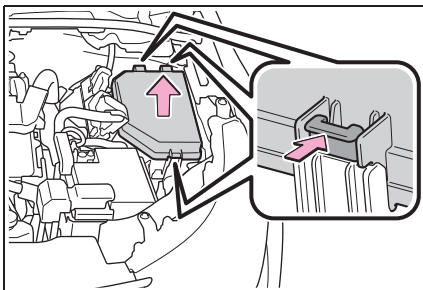

- ▶ Under the passenger's side instrument panel

Remove the lid.

Make sure to push the claw when removing/installing the lid.

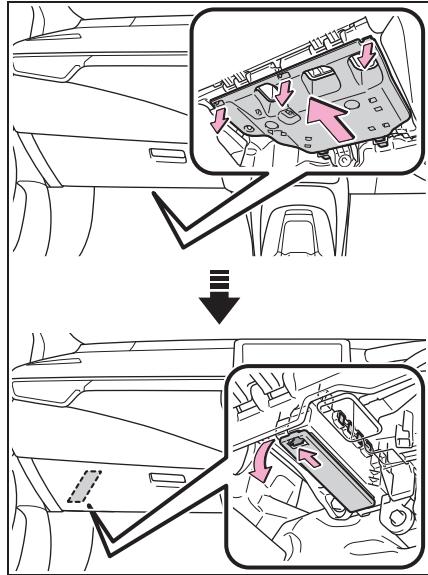

- 3 Remove the fuse with the pull-out tool.

Only type A fuse can be removed using the pullout tool.

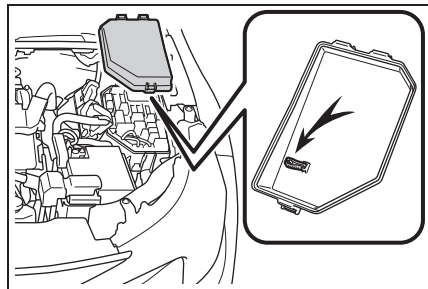

- 4 Check if the fuse is blown.

Replace the blown fuse with a new fuse of an appropriate amperage rating. The amperage rating can be found on the fuse box lid.

▶ Type A

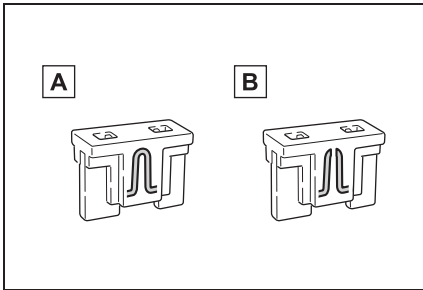

A Normal fuse

B Blown fuse

▶ Type B

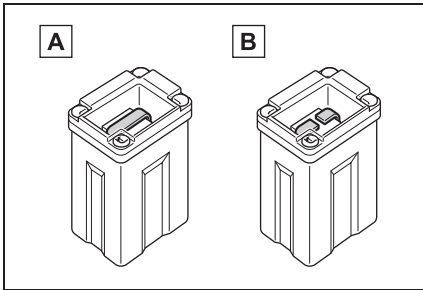

A Normal fuse

B Blown fuse

▶ Type C

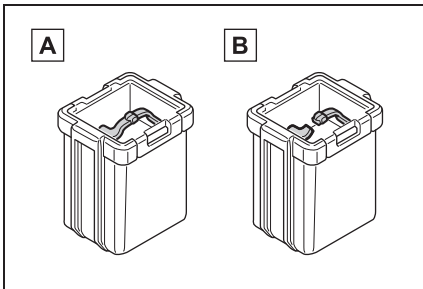

A Normal fuse

B Blown fuse

▶ Type D

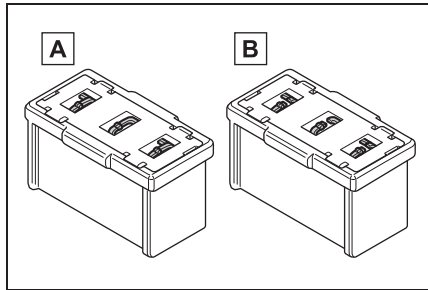

A Normal fuse

B Blown fuse

■ After a fuse is replaced

- When installing the lid, make sure that the tab is installed securely.
- If the lights do not turn on even after the fuse has been replaced, a bulb may need replacement. (→P.285)
- If the replaced fuse blows again, have the vehicle inspected by your Toyota dealer.

■ If there is an overload in a circuit

The fuses are designed to blow, protecting the wiring harness from damage.

■ When replacing light bulbs

Toyota recommends that you use genuine Toyota products designed for this vehicle.

Because certain bulbs are connected to circuits designed to prevent overload, non-genuine parts of parts not designed for this vehicle may be unusable.



WARNING

■ To prevent system breakdowns and vehicle fire

Observe the following precautions. Failure to do so may cause damage to the vehicle, and possibly a fire or injury.

**WARNING**

- Never use a fuse of a higher amperage rating than that indicated, or use any other object in place of a fuse.
- Always use a genuine Toyota fuse or equivalent.
Never replace a fuse with a wire, even as a temporary fix.
- Do not modify the fuses or fuse boxes.

**NOTICE****Before replacing fuses**

Have the cause of electrical overload determined and repaired by your Toyota dealer as soon as possible.

Light bulbs

You may replace the following bulbs by yourself. The difficulty level of replacement varies depending on the bulb. As there is a danger that components may be damaged, we recommend that replacement is carried out by your Toyota dealer.

Preparing for light bulb replacement

Check the wattage of the light bulb to be replaced. (→P.344)

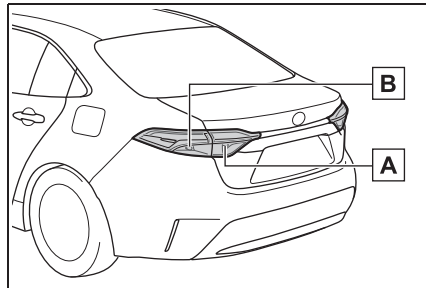
Bulb locations

A Back-up light

B Rear turn signal lights

■ Bulbs that need to be replaced by your Toyota dealer

- Headlights
- Daytime running lights/front position lights
- Front turn signal lights
- Side turn signal lights

- Tail lights
- Stop lights
- Rear fog light
- High mounted stoplight
- License plate lights

■ LED light bulbs

The lights other than the rear turn signal lights and back-up light consist of a number of LEDs. If any of the LEDs burn out, take your vehicle to your Toyota dealer to have the light replaced.

■ Condensation build-up on the inside of the lens

In certain situations, such as when driving in the rain or when washing the vehicle, condensation may form on the inner side of the headlight lens and other lights. As each light has a ventilation hole, moist air may enter. If the ambient temperature is low, condensation may form temporarily, but it will dissipate as the inside of the light is warmed up. As the condensation is due to a phenomenon similar to windows fogging in the rain, it does not indicate a malfunction.

Contact your Toyota dealer for more information in the following situations:

- Large drops of water have built up on the inside of the lens.
- Water has built up inside the headlight.

■ When replacing light bulbs

→P.284

Replacing light bulbs

■ Rear turn signal lights

- 1 Open the trunk lid.
- 2 Insert a flathead screwdriver between the cover and the light assembly and pry up the cover

to disengage the claws (indicated by a dotted line).

To prevent scratching the vehicle, wrap the tip of the flathead screwdriver with a cloth, etc.

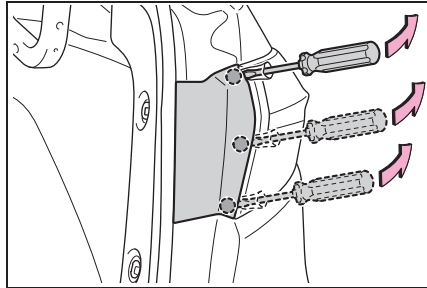

- 3 Pull the cover toward the rear of the vehicle and remove the cover.

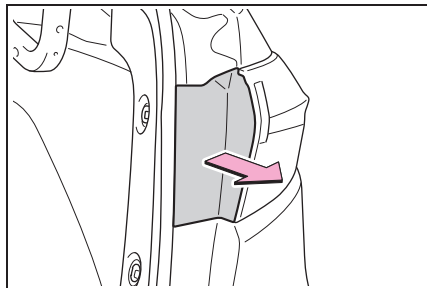

- 4 Remove the 2 screws and then remove the light assembly by pulling it straight back.

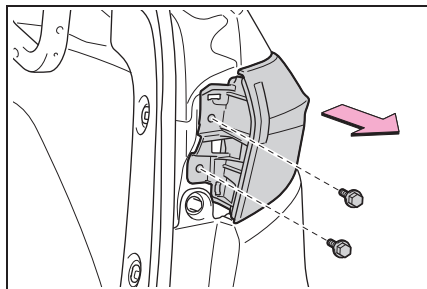

- 5** Turn the bulb base counterclockwise.

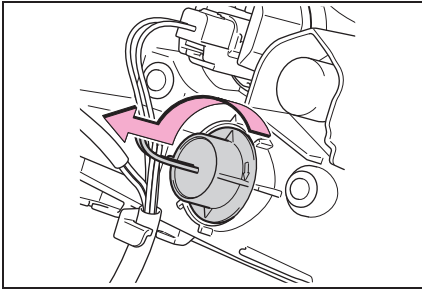

- 6** Remove the light bulb.

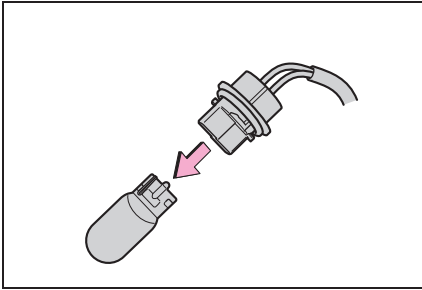

- 7** When installing the light bulb, install it by conducting steps **6** and **5** with the directions reversed.

- 8** Install the light assembly and then install the 2 screws.

Align the guide **A** and pin **B** on the light assembly with the mounting when installing it.

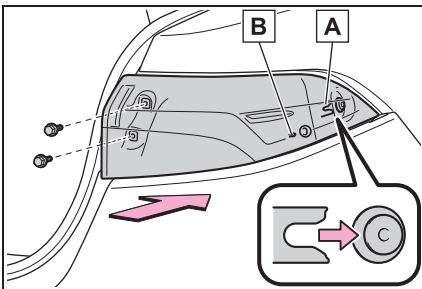

- 9** Install the cover.

■ Back-up light

- 1** Open the trunk lid, remove the clips, and pull back the cover.

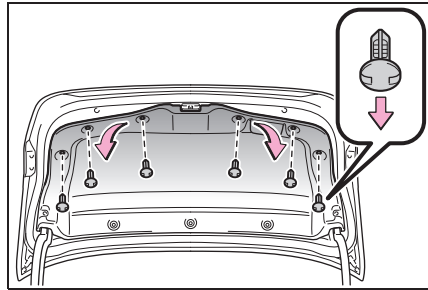

- 2** Turn the bulb base counterclockwise and remove it.

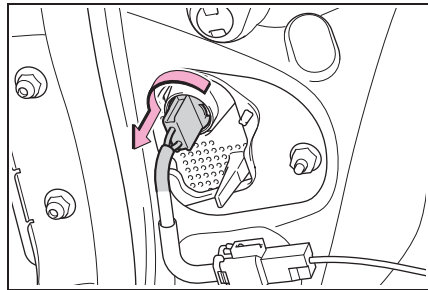

- 3** Remove the light bulb.

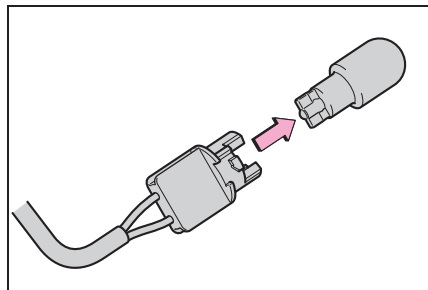

- 4** When installing, reverse the steps listed.

**WARNING****■ Replacing light bulbs**

- Turn off the lights. Do not attempt to replace the bulb immediately after turning off the lights. The bulbs become very hot and may cause burns.
- Do not touch the glass portion of the light bulb with bare hands. When it is unavoidable to hold the glass portion, use and hold with a clean dry cloth to avoid getting moisture and oils on the bulb. Also, if the bulb is scratched or dropped, it may blow out or crack.
- Fully install light bulbs and any parts used to secure them. Failure to do so may result in heat damage, fire, or water entering the light unit. This may damage the lights or cause condensation to build up on the lens.

■ To prevent damage or fire

Make sure bulbs are fully seated and locked.

When trouble arises

7

7-1. Essential information

Emergency flashers.....**290**

If your vehicle has to be
stopped in an emergency
.....**290**

If the vehicle is submerged or
water on the road is rising
.....**291**

7-2. Steps to take in an emergency

If your vehicle needs to be
towed.....**293**

If you think something is wrong
.....**296**

If a warning light turns on or a
warning buzzer sounds...**298**

If a warning message is displayed.....**305**

If you have a flat tire (vehicles
without spare tire).....**309**

If you have a flat tire (vehicles
with a spare tire).....**319**

If the hybrid system will not
start**326**

If you lose your keys.....**327**

If the electronic key does not
operate properly**328**

If the 12-volt battery is discharged**330**

If your vehicle overheats...**333**

If the vehicle becomes stuck
.....**336**

Emergency flashers

The emergency flashers are used to warn other drivers when the vehicle has to be stopped on the road due to a breakdown, etc.

Operating instructions

Press the switch.

All the turn signal lights will flash.

To turn them off, press the switch once again.

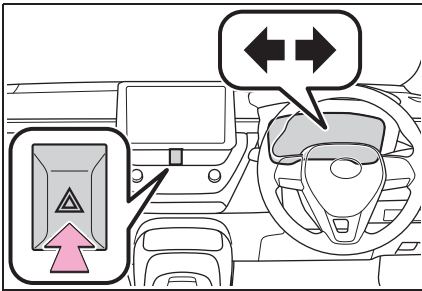

Emergency flashers

- If the emergency flashers are used for a long time while the hybrid system is not operating (while the “READY” indicator is not illuminated), the 12-volt battery may discharge.
- If any of the SRS airbags deploy (inflate) or in the event of a strong rear impact, the emergency flashers will turn on automatically. The emergency flashers will turn off automatically after operating for approximately 20 minutes. To manually turn the emergency flashers off, press the switch twice. (The emergency flashers may not turn on automatically depending on the force of the impact and conditions of the collision.)

If your vehicle has to be stopped in an emergency

Only in an emergency, such as if it becomes impossible to stop the vehicle in the normal way, stop the vehicle using the following procedure:

Stopping the vehicle

- 1 Steadily step on the brake pedal with both feet and firmly depress it.

Do not pump the brake pedal repeatedly as this will increase the effort required to slow the vehicle.

- 2 Shift the shift lever to N.
 - ▶ If the shift lever is shifted to N
- 3 After slowing down, stop the vehicle in a safe place by the road.
- 4 Stop the hybrid system.
 - ▶ If the shift lever cannot be shifted to N
- 3 Keep depressing the brake pedal with both feet to reduce vehicle speed as much as possible.
- 4 To stop the hybrid system, press and hold the power switch for 2 consecutive seconds or more,

or press it briefly 3 times or more in succession.

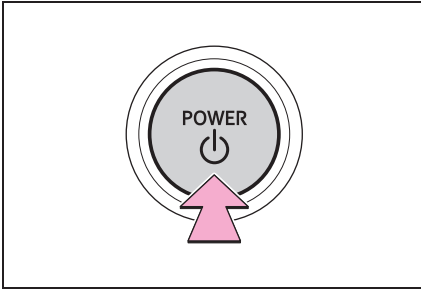

- 5 Stop the vehicle in a safe place by the road.



WARNING

■ **If the hybrid system has to be turned off while driving**

Power assist for the steering wheel will be lost, making the steering wheel heavier to turn. Decelerate as much as possible before turning off the hybrid system.

If the vehicle is submerged or water on the road is rising

This vehicle is not designed to be able to drive on roads that are deeply flooded with water. Do not drive on roads where the roads may be submerged or the water may be rising. It is dangerous to remain in the vehicle, if it anticipated that the vehicle will be flooded or set a drift. Remain calm and follow the following.

- If the door can be opened, open the door and exit the vehicle.
- If the door can not be opened, open the window using the power window switch and ensure an escape route.
- If the window can be opened, exit the vehicle through the window.
- If the door and window cannot be opened due to the rising water, remain calm, wait until the water level inside the vehicle rises to the point that the water pressure inside of the vehicle equals the water pressure outside of the vehicle and then open the door after waiting for the rising water to enter the vehicle, and exit the vehicle. When the outside water level exceeds half the height of the door, the door cannot be opened from the inside due to

water pressure.

■ **Water level exceeds the floor**

When the water level exceeds the floor and time has passed, the electrical equipment will get damaged, the power windows will not operate, the engine and motor stop, and the vehicle may not be able to get moving.

■ **Using an emergency escape hammer***

Laminated glass is used in the windshield on this vehicle.
Laminated glass cannot be shattered with an emergency hammer*.
Tempered glass is used in the windows on this vehicle.

*: Contact your Toyota dealer or aftermarket accessory manufacturer for further information about an emergency hammer.



WARNING

■ **Caution while driving**

Do not drive on roads where the roads may be submerged or the water may be rising. Otherwise the vehicle may be damaged and cannot move, as well as become flooded and set a drift, which may lead to death.

If your vehicle needs to be towed

If towing is necessary, we recommend having your vehicle towed by your Toyota dealer or commercial towing service, using a wheel-lift type truck or flatbed truck.

Use a safety chain system for all towing, and abide by all state/provincial and local laws.

WARNING

Observe the following precautions. Failure to do so may result in death or serious injury.

■ When towing the vehicle

Be sure to transport the vehicle with the front wheels raised or with all four wheels raised off the ground. If the vehicle is towed with the front wheels contacting the ground, the drivetrain and related parts may be damaged or electricity generated by the operation of the motor may cause a fire to occur depending on the nature of the damage or malfunction.

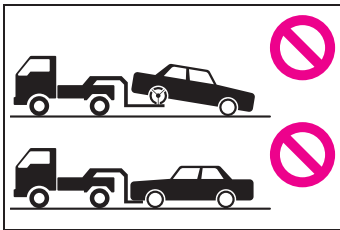

■ While towing

- When towing using cables or chains, avoid sudden starts, etc. which place excessive stress on the towing eyelets, cables or chains. The towing eyelets, cables or chains may become damaged, broken debris may hit people, and cause serious damage.
- Do not turn the power switch off. There is a possibility that the steering wheel is locked and cannot be operated.

■ Installing towing eyelets to the vehicle

Make sure that towing eyelets are installed securely. If not securely installed, towing eyelets may come loose during towing.

NOTICE

■ To prevent damage to the vehicle when towing using a wheel-lift type truck

- Do not tow the vehicle from the rear when the power switch is off.
- When raising the vehicle, ensure adequate ground clearance for towing at the opposite end of the raised vehicle. Without adequate clearance, the vehicle could be damaged while being towed.

■ To prevent damage to the vehicle when towing with a sling-type truck

Do not tow with a sling-type truck, either from the front or rear.

■ To prevent damage to the vehicle during emergency towing

Do not secure cables or chains to the suspension components.

Situations when it is necessary to contact dealers before towing

The following may indicate a problem with your transmission. Contact your Toyota dealer or commercial towing service before towing.

- The hybrid system warning message is shown on the multi-information display and the vehicle does not move.
- The vehicle makes an abnormal sound.

Towing with a wheel-lift type truck

► From the front

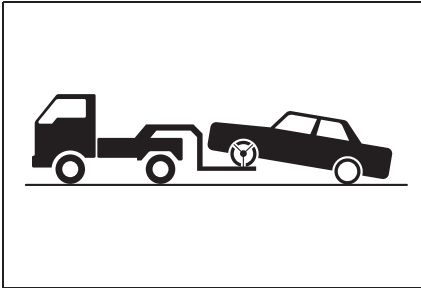

Release the parking brake.

Turn automatic mode off. (→P.149)

► From the rear

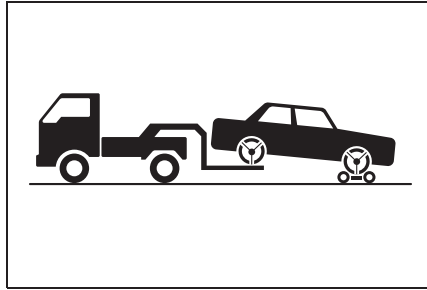

Use a towing dolly under the front wheels.

⚠ NOTICE

■ Towing with a sling-type truck

Do not tow with a sling-type truck to prevent body damage.

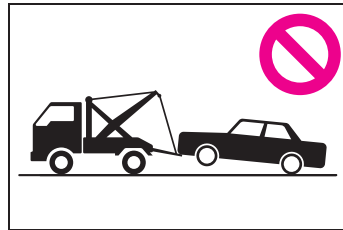

Using a flatbed truck

If your vehicle is transported by a flatbed truck, it should be tied down at the locations shown in the illustration.

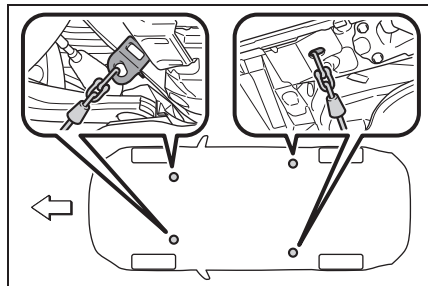

If you use chains or cables to tie down your vehicle, the angles shaded in black must be 45°.

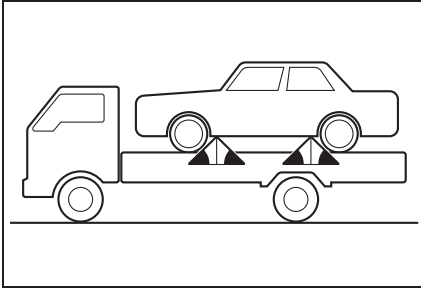

NOTICE

■ Using a flatbed truck

Do not overly tighten the tie downs or the vehicle may be damaged.

Emergency towing

If a tow truck is not available in an emergency, your vehicle may be temporarily towed using cables or chains secured to the emergency towing eyelets. This should only be attempted on hard surfaced roads for short distance at under 30 km/h (18 mph).

A driver must be in the vehicle to steer and operate the brakes. The vehicle's wheels, drive train, axles, steering and brakes must be in good condition.

Emergency towing procedure

To have your vehicle towed by another vehicle, the towing eyelet must be installed to your vehicle.

Install the towing eyelet using the following procedure.

- 1 Take out the wheel nut wrench and towing eyelet. (→P.320)
- 2 Remove the eyelet cover using a flathead screwdriver.

To protect the bodywork, place a rag between the screwdriver and the vehicle body as shown in the illustration.

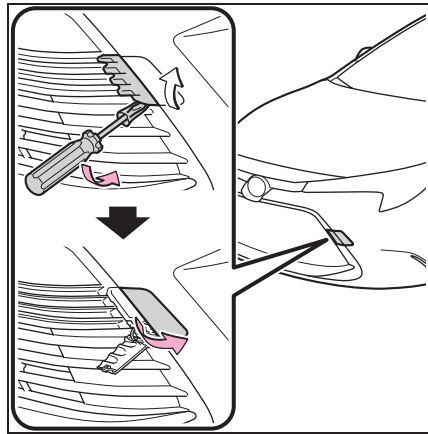

- 3 Insert the towing eyelet into the hole and tighten partially by hand.

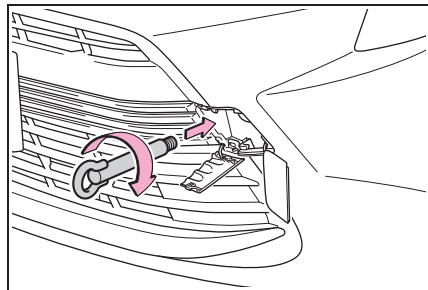

- 4 Tighten down the towing eyelet securely using a wheel nut wrench or hard metal bar.

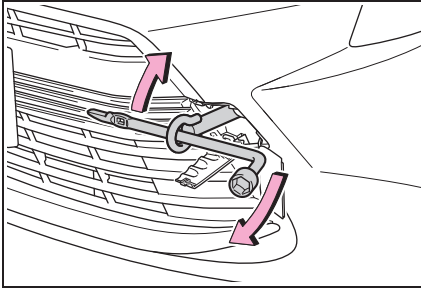

- 5 Securely attach cables or chains to the towing eyelet.

Take care not to damage the vehicle body.

- 6 Enter the vehicle being towed and start the hybrid system.

If the hybrid system does not start, turn the power switch to ON.

- 7 Shift the shift lever to N and release the parking brake. Turn automatic mode off.

(→P.149)

When the shift lever cannot be shifted: →P.147

■ While towing

If the hybrid system is off, the power assist for the brakes and steering will not function, making steering and braking more difficult.

■ Wheel nut wrench

Wheel nut wrench is installed in trunk. (→P.320)

If you think something is wrong

If you notice any of the following symptoms, your vehicle probably needs adjustment or repair. Contact your Toyota dealer as soon as possible.

Visible symptoms

- Fluid leaks under the vehicle. (Water dripping from the air conditioning after use is normal.)
- Flat-looking tires or uneven tire wear
- Engine coolant temperature gauge needle continually points higher than normal.

Audible symptoms

- Changes in exhaust sound
- Excessive tire squeal when cornering
- Strange noises related to the suspension system
- Pinging or other noises related to the hybrid system

Operational symptoms

- Engine missing, stumbling or running roughly
- Appreciable loss of power
- Vehicle pulls heavily to one side when braking

- Vehicle pulls heavily to one side when driving on a level road
- Loss of brake effectiveness, spongy feeling, pedal almost touches the floor

If a warning light turns on or a warning buzzer sounds

Calmly perform the following actions if any of the warning lights comes on or flashes. If a light comes on or flashes, but then goes off, this does not necessarily indicate a malfunction in the system. However, if this continues to occur, have the vehicle inspected by your Toyota dealer.

Actions to the warning lights or warning buzzers

■ **Brake system warning light (warning buzzer)**

Warning light	Details/Actions
	<p>Indicates that:</p> <ul style="list-style-type: none"> ● The brake fluid level is low; or ● The brake system is malfunctioning <p>→ Immediately stop the vehicle in a safe place and contact your Toyota dealer. Continuing to drive the vehicle may be dangerous.</p>

■ **Brake system warning light (warning buzzer)**

Warning light	Details/Actions
	<p>Indicates a malfunction in:</p> <ul style="list-style-type: none"> ● The regenerative braking system; ● The electronically controlled brake system; or ● The parking brake system <p>→ Have the vehicle inspected by your Toyota dealer immediately.</p>

■ **High coolant temperature warning light* (warning buzzer)**

Warning light	Details/Actions
	<p>Indicates that the engine coolant temperature is excessively high</p> <p>→ Immediately stop the vehicle in a safe place. Handling method (→P.333)</p>

*: This light illuminates on the multi-information display.

■ Hybrid system overheat warning light* (warning buzzer)

Warning light	Details/Actions
	Indicates that the temperature of the hybrid system is excessively high → Stop the vehicle in a safe place. Handling method (→P.333)

*: This light illuminates on the multi-information display.

■ Charging system warning light

Warning light	Details/Actions
	Indicates a malfunction in the vehicle's charging system → Immediately stop the vehicle in a safe place and contact your Toyota dealer.

■ Low engine oil pressure warning light* (warning buzzer)

Warning light	Details/Actions
	Indicates that the engine oil pressure is excessively low → Immediately stop the vehicle in a safe place and contact your Toyota dealer.

*: This light illuminates on the multi-information display.

■ Malfunction indicator lamp (warning buzzer)

Warning light	Details/Actions
	Indicates a malfunction in: ● The hybrid system; ● The electronic engine control system; or ● The electronic throttle control system → Immediately stop the vehicle in a safe place and contact your Toyota dealer.

■ SRS warning light (warning buzzer)

Warning light	Details/Actions
	Indicates a malfunction in: ● The SRS airbag system; or ● The seat belt pretensioner system → Have the vehicle inspected by your Toyota dealer immediately.

■ **ABS warning light**

Warning light	Details/Actions
	<p>Indicates a malfunction in:</p> <ul style="list-style-type: none"> ● The ABS; or ● The brake assist system <p>→ Have the vehicle inspected by your Toyota dealer immediately.</p>

■ **Inappropriate pedal operation warning light* (warning buzzer)**

Warning light	Details/Actions
	<p>When a buzzer sounds:</p> <ul style="list-style-type: none"> ● Brake Override System is malfunctioning ● Drive-Start Control is malfunctioning ● Drive-Start Control is operating <p>→ Follow the instructions displayed on the multi-information display. (→P.305)</p> <p>When a buzzer does not sound: Brake Override System is operating.</p> <p>→ Release the accelerator pedal and depress the brake pedal.</p>

*: This light illuminates on the multi-information display.

■ **Electric power steering system warning light (warning buzzer)**

Warning light	Details/Actions
 <p>(Red/yellow)</p>	<p>Indicates a malfunction in the EPS (Electric Power Steering) system</p> <p>→ Have the vehicle inspected by your Toyota dealer immediately.</p>

■ **Low fuel level warning light**

Warning light	Details/Actions
	<p>Indicates that remaining fuel is approximately 6.4 L (1.7 gal., 1.4 Imp. gal.) or less</p> <p>→ Refuel the vehicle.</p>



■ Driver's and front passenger's seat belt reminder light (warning buzzer)*

Warning light	Details/Actions
	<p>Warns the driver and/or front passenger to fasten their seat belts → Fasten the seat belt. If the front passenger's seat is occupied, the front passenger's seat belt also needs to be fastened to make the warning light (warning buzzer) turn off.</p>

*: Driver's and front passenger's seat belt warning buzzer:

The driver's and front passenger's seat belt warning buzzer sounds to alert the driver and front passenger that his or her seat belt is not fastened. If the seat belt is unfastened, the buzzer sounds intermittently for a certain period of time after the vehicle reaches a certain speed.

■ Rear passengers' seat belt reminder lights (warning buzzer)*

Warning light	Details/Actions
 (12.3-inch display)  (7-inch or 12.3-inch display)	<p>Warns the rear passengers to fasten their seat belts → Fasten the seat belt.</p>

*: Rear passengers' seat belt warning buzzer:

The rear passengers' seat belt warning buzzer sounds to alert the rear passenger that his or her seat belt is not fastened. If the seat belt is unfastened, the buzzer sounds intermittently for a certain period of time after the vehicle reaches a certain speed.

■ PCS warning light (warning buzzer)

Warning light	Details/Actions
	<p>Indicates a malfunction in the PCS (Pre-Collision System).</p> <p>→ Follow the instructions displayed on the multi-information display. (→P.305)</p> <p>If the PCS (Pre-Collision System) or VSC (Vehicle Stability Control) system is disabled, the PCS warning light will illuminate.</p> <p>→ P.180</p>

■ LTA indicator (warning buzzer)

Warning light	Details/Actions
	<p>Indicates a malfunction in the LTA (Lane Tracing Assist).</p> <p>→ Follow the instructions displayed on the multi-information display. (→P.305)</p>

■ LDA indicator (warning buzzer)

Warning light	Details/Actions
	<p>Indicates a malfunction in the LDA (Lane Departure Alert).</p> <p>→ Follow the instructions displayed on the multi-information display. (→P.305)</p>

■ Dynamic radar cruise control indicator (warning buzzer)

Warning light	Details/Actions
	<p>Indicates a malfunction in the dynamic radar cruise control.</p> <p>→ Follow the instructions displayed on the multi-information display. (→P.305)</p>

■ Cruise control indicator (warning buzzer)

Warning light	Details/Actions
	<p>Indicates a malfunction in the cruise control.</p> <p>→ Follow the instructions displayed on the multi-information display. (→P.305)</p>

■ Driving assist information indicator

Warning light	Details/Actions
	<p>Indicates either of the following systems may be malfunctioning.</p> <ul style="list-style-type: none"> ● PCS (Pre-Collision System) ● LDA (Lane Departure Alert) <p>→ Follow the instructions displayed on the multi-information display. (→P.305)</p> <p>Indicates one of the following systems is malfunctioning or disabled.</p> <ul style="list-style-type: none"> ● BSM (Blind Spot Monitor)* ● RCTA(Rear cross traffic alert)* ● SEA (Safe Exit Assist)* <p>→ Follow the instructions displayed on the multi-information display. (→P.305)</p>

*: If equipped

■ Slip indicator

Warning light	Details/Actions
	<p>Indicates a malfunction in:</p> <ul style="list-style-type: none"> ● The VSC system; ● The TRC system; or ● The hill-start assist control system <p>→ Have the vehicle inspected by your Toyota dealer immediately.</p>

■ Parking brake indicator

Warning light	Details/Actions
 <p>(Flashes)</p>	<p>It is possible that the parking brake is not fully engaged or released</p> <p>→ Operate the parking brake switch once again.</p> <p>This light comes on the parking brake is not released. If the light turns off after the parking brakes is fully released, the system is operating normally.</p>

■ Brake hold operated indicator

Warning light	Details/Actions
	Indicates a malfunction in the brake hold system → Have the vehicle inspected by your Toyota dealer immediately.

■ Warning buzzer

In some cases, the buzzer may not be heard due to being in a noisy location or audio sound.

■ Front passenger detection sensor, seat belt reminder and warning buzzer

- If luggage is placed on the front passenger seat, the front passenger detection sensor may cause the warning light to flash and the warning buzzer to sound even if a passenger is not sitting in the seat.
- If a cushion is placed on the seat, the sensor may not detect a passenger, and the warning light may not operate properly.

■ Electric power steering system warning light (warning buzzer)

When the 12-volt battery charge becomes insufficient or the voltage temporarily drops, the electric power steering system warning light may come on and the warning buzzer may sound.

■ When the electric power steering system warning light comes on

When the light comes on yellow, the assist to the power steering is restricted. When the light comes on red, the assist to the power steering is lost and handling operations of the steering wheel become extremely heavy.

When steering wheel operations are heavier than usual, grip the steering wheel firmly and operate it using more force than usual.



WARNING

■ If both the ABS and the brake system warning lights remain on

Stop your vehicle in a safe place immediately and contact your Toyota dealer.

The vehicle will become extremely unstable during braking, and the ABS system may fail, which could cause an accident resulting in death or serious injury.

If a warning message is displayed

The multi-information display shows warnings for system malfunctions and incorrectly performed operations, and messages that indicate a need for maintenance. When a message is displayed, perform the appropriate corrective action for the message.

If a warning message is displayed again after the appropriate actions have been performed, contact your Toyota dealer.

Additionally, if a warning light comes on or flashes at the same time that a warning message is displayed, take the appropriate corrective action for the warning light. (→P.298)

■ Warning messages

The warning messages explained below may differ from the actual messages according to operation conditions and vehicle specifications.

■ Warning buzzer

A buzzer may sound when a message is displayed.

The buzzer may not be audible if the vehicle is in a noisy location or if the audio system volume is high.

■ If “Engine Oil Level Low Add or Replace” is displayed

The engine oil level is low. Check the level of the engine oil, and add if necessary.

This message may appear if the vehicle is stopped on a slope. Move the vehicle to a level surface and check to see if the message disappears.

■ If “Hybrid System Stopped Steering Power Low” is displayed

This message is displayed if the hybrid system is stopped while driving.

When steering wheel operations are heavier than usual, grip the steering wheel firmly and operate it using more force than usual.

■ If “Hybrid System Overheated Output Power Reduced” is displayed

This message may be displayed when driving under severe operating conditions. (For example, when driving up a long steep hill.)

Handling method: →P.333

■ If “Shift to P Before Exiting Vehicle” is displayed

This message is displayed when the driver’s door is opened without turning the power switch off with the shift lever in any position other than P. Shift the shift lever to P.

■ If “Traction Battery Needs to be Protected Refrain from the Use of N Position” is displayed

This message may be displayed when the shift lever is in N.

As the hybrid battery (traction battery) cannot be charged when the shift lever is in N, shift the shift lever to P when the vehicle is stopped.

■ If “Traction Battery Needs to be Protected Shift into P to Restart” is displayed

This message is displayed when the hybrid battery (traction battery) charge has become extremely low because the shift lever has been left in N for a certain amount of time.

When operating the vehicle, shift to P and restart the hybrid system.

■ If **“Shift is in N Release Accelerator Before Shifting”** is displayed

The accelerator pedal has been depressed when the shift lever is in N.

Release the accelerator pedal and shift the shift lever to D or R.

■ If **“Press Brake when Vehicle is Stopped Hybrid System may Overheat”** is displayed

The message may be displayed when the accelerator pedal is depressed to hold the vehicle while the vehicle is stopped on an incline, etc. The hybrid system may overheat. Release the accelerator pedal and depress the brake pedal.

■ If **“Auto Power OFF to Conserve Battery”** is displayed

Power was cut off due to the automatic power off function. Next time when starting the hybrid system, operate the hybrid system for approximately 5 minutes to recharge the 12-volt battery.



■ If **“Headlight System Malfunction Visit Your Dealer”** is displayed

The following systems may be malfunctioning. Have the vehicle inspected by your Toyota dealer immediately.

- The LED headlight system
- Automatic High Beam

■ If **“System Malfunction Visit Your Dealer”** is displayed

Indicates one of the following systems is disabled.





- PCS (Pre-Collision system)
- LDA (Lane Departure Alert)
- LTA (Lane Tracing Assist)
- AHB (Automatic High Beam)
- Dynamic radar cruise control
-  RSA (Road Sign Assist)
-  BSM (Blind Spot Monitor) (if equipped)
-  RCTA (Rear Cross Traffic Alert) (if equipped)

-  SEA (Safe Exit Assist) (if equipped)

Have the vehicle inspected by your Toyota dealer immediately.

■ If **“System Stopped See Owner’s Manual”** is displayed

Indicates one of the following systems is disabled.

- PCS (Pre-Collision system)
- LDA (Lane Departure Alert)
- LTA (Lane Tracing Assist)
- AHB (Automatic High Beam)
- Dynamic radar cruise control
-  RSA (Road Sign Assist)
-  BSM (Blind Spot Monitor) (if equipped)
-  RCTA (Rear Cross Traffic Alert) (if equipped)
-  SEA (Safe Exit Assist) (if equipped)

Follow the following correction methods.

- Check the voltage of the battery
- Check the sensors that the Toyota Safety Sense uses for foreign matter covering them. Remove them if any. (→P.166)

Indicates the sensors may not be operating properly. (→P.168)

When problems are solved and the sensors are operational, this indication may disappear by itself.

■ If **“System Stopped Front Camera Low Visibility See Owner’s Manual”** is displayed

Indicates one of the following systems is disabled.

- PCS (Pre-Collision system)
- LDA (Lane Departure Alert)
- LTA (Lane Tracing Assist)
- AHB (Automatic High Beam)
- Dynamic radar cruise control
-  RSA (Road Sign Assist)

Follow the following correction methods.

- Using the windshield wipers, remove the dirt or foreign matter from the windshield.
- Using the air conditioning system, defog the windshield.
- Close the hood, remove any stickers, etc. to clear the obstruction in front of the front camera.

■ If **“System Stopped Front Camera Out of Temperature Range Wait until Normal Temperature” is displayed**

Indicates one of the following systems is disabled.

- PCS (Pre-Collision system)
- LDA (Lane Departure Alert)
- LTA (Lane Tracing Assist)
- AHB (Automatic High Beam)
- Dynamic radar cruise control
-  RSA (Road Sign Assist)

Follow the following correction methods.

- If the front camera is hot, such as after the vehicle is parked in the sun, use the air conditioning system to decrease the temperature around the front camera
- If a sunshade was used when the vehicle was parked, depending on its type, the sunlight reflected from the surface of the sunshade may cause the temperature of the front camera to become excessively high
- If the front camera is cold, such after the vehicle is parked in an extremely cold environment, use the air conditioning system to increase the temperature around the front camera

■ If **“System Stopped Front Radar Sensor Blocked Clean Radar Sensor” is displayed**

Indicates one of the following systems is disabled.

- PCS (Pre-Collision system)
- LDA (Lane Departure Alert)
- LTA (Lane Tracing Assist)

- AHB (Automatic High Beam)
- Dynamic radar cruise control

Follow the following correction methods.

- Check if there is any foreign matter attached to the radar sensor or radar sensor cover and clean them if necessary (→P.166)
- This message may be displayed when driving in an open area with few nearby vehicles or structures, such as a desert, grasslands, suburbs, etc.

The message may be cleared by driving the vehicle in an area with structures, vehicles, etc., nearby.

■ If **“System Stopped Front Radar Sensor Out of Temperature Range Wait until Normal Temperature” is displayed**

Indicates one of the following systems is disabled.

- PCS (Pre-Collision system)
- LDA (Lane Departure Alert)
- LTA (Lane Tracing Assist)
- AHB (Automatic High Beam)
- Dynamic radar cruise control

Follow the following correction methods.

The temperature of the radar sensor is outside of the operating range. Wait for the temperature to become appropriate.

■ If **“System Stopped Front Radar In Self Calibration See Owner’s Manual” is displayed**

Indicates one of the following systems is disabled.

- PCS (Pre-Collision system)
- LDA (Lane Departure Alert)
- LTA (Lane Tracing Assist)
- AHB (Automatic High Beam)
- Dynamic radar cruise control

Follow the following correction methods.

- Check if there is any foreign matter attached to the radar sensor or radar sensor cover and clean them if necessary (→P.166)

- The radar sensor may be misaligned and will be adjusted automatically while driving. Continue driving for a while.

■ **If “Cruise Control Unavailable See Owner’s Manual” is displayed**

Indicates one of the following systems is disabled.

- Dynamic radar cruise control
- Cruise control

A message is displayed when the driving assist switch is pushed repeatedly.

Press the driving assist switch quickly and firmly.

■ **If a message that indicates the need for visiting your Toyota dealer is displayed**

The system or part shown on the multi-information display is malfunctioning. Have the vehicle inspected by your Toyota dealer immediately.

■ **If a message that indicates the need for referring to Owner’s Manual is displayed**

- If “Engine Coolant Temp High” is displayed, follow the instructions accordingly. (→P.333)
- If any of the following messages are displayed on the multi-information display, it may indicate a malfunction. Have the vehicle inspected by your Toyota dealer immediately.
 - “Smart Entry & Start System Malfunction”
 - “Hybrid System Malfunction”
 - “Check Engine”
 - “Hybrid Battery System Malfunction”
 - “Accelerator System Malfunction”
- If any of the following messages are displayed on the multi-information display, it may indicate a malfunction. Immediately stop the vehicle and contact your Toyota dealer.
 - “Braking Power Low”
 - “Charging System Malfunction”
 - “Oil Pressure Low”
- If any of the following messages are shown on the multi-information display,

the vehicle may have run out of fuel. Stop the vehicle in a safe place and, if the fuel level is low, refuel the vehicle. (→P.61)

- “Hybrid System Stopped”
- “Engine Stopped”
- If “Maintenance Required for Traction Battery Cooling Parts See Owner’s Manual” is shown, the filter may be clogged, the air intake vent may be blocked, or there may be a gap in the duct. Therefore, perform the following correction procedure.
 - Cleaning the hybrid battery (traction battery) air intake vents (→P.278)

If the warning message is shown even if the vents are cleaned, have the vehicle inspected by your Toyota dealer.



NOTICE

■ **If “High Power Consumption Power to Climate Temporarily Limited” is displayed frequently**

There is a possible malfunction relating to the charging system or the 12-volt battery may be deteriorating. Have the vehicle inspected by your Toyota dealer.

If you have a flat tire (vehicles without spare tire)

Your vehicle is not equipped with a spare tire, but instead is equipped with an emergency tire puncture repair kit.

A puncture caused by a nail or screw passing through the tire tread can be repaired temporarily using the emergency tire puncture repair kit. (The kit contains a bottle of sealant. The sealant can be used only once to temporarily repair one tire without removing the nail or screw from the tire.)

Depending on the damage, this kit cannot be used to repair the tire. (→P.309)

After temporarily repairing the tire with the kit, have the tire repaired or replaced by your Toyota dealer. Repairs conducted using the emergency tire puncture repair kit are only a temporary measure. Have the tire repaired and replaced as soon as possible.



WARNING

■ If you have a flat tire

Do not continue driving with a flat tire. Driving even a short distance with a flat tire can damage the tire and the wheel beyond repair, which could result in an accident.

Before repairing the tire

- Stop the vehicle in a safe place on a hard, flat surface.
- Set the parking brake.
- Shift the shift lever to P.
- Stop the hybrid system.
- Turn on the emergency flashers.
- Check the degree of the tire damage.

A tire should only be repaired with the emergency tire puncture repair kit if the damage is caused by a nail or screw passing through the tire tread.

- Do not remove the nail or screw from the tire. Removing the object may widen the opening and make emergency repair with the repair kit impossible.
- To avoid sealant leakage, move the vehicle until the area of the puncture, if known, is positioned at the top of the tire.

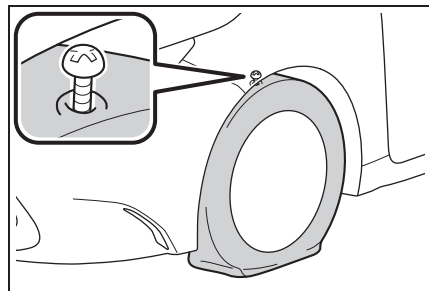

■ A flat tire that cannot be repaired with the emergency tire puncture repair kit

In the following cases, the tire cannot be repaired with the emergency tire punc-

ture repair kit. Contact your Toyota dealer.

- When the tire is damaged due to driving without sufficient air pressure
- When there are any cracks or damage at any location on the tire, such as on the side wall, except the tread
- When the tire is visibly separated from the wheel
- When the cut or damage to the tread is 4 mm (0.16 in.) long or more
- When the wheel is damaged
- When 2 or more tires have been punctured
- When 2 or more sharp objects such as nails or screws have passed through the tread on a single tire
- When the sealant has expired

Location of the emergency tire puncture repair kit and towing eyelet

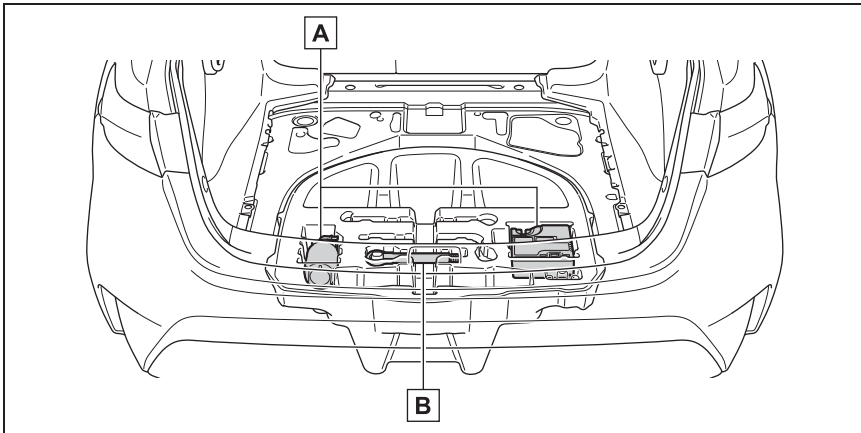

A Emergency tire puncture repair kit

B Towing eyelet

Emergency tire puncture repair kit components

▶ Bottle

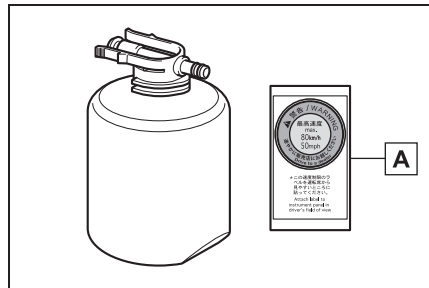

A Sticker

► Compressor

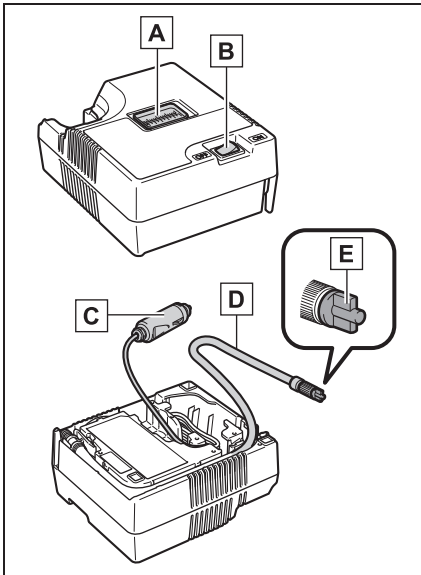

- A** Air pressure gauge
- B** Compressor switch
- C** Power plug
- D** Hose
- E** Air release cap

■ Note for checking the emergency tire puncture repair kit

Check the sealant expiry date occasionally.

The expiry date is shown on the bottle. Do not use sealant whose expiry date has already passed. Otherwise, repairs conducted using the emergency tire puncture repair kit may not be performed properly.

■ Emergency tire puncture repair kit

- The emergency tire puncture repair kit is for filling the car tire with air.
- The sealant has a limited life span. The expiry date is marked on the bottle. The sealant should be replaced with a new bottle before the expiry

date. Contact your Toyota dealer for replacement.

- The sealant stored in the emergency tire puncture repair kit can be used only once to temporarily repair a single tire. If the sealant in the bottle and other parts of the kit have been used and need to be replaced, contact your Toyota dealer.
- The compressor can be used repeatedly.
- The sealant can be used when the outside temperature is from -40°C (-40°F) to 60°C (140°F).
- The kit is exclusively designed for size and type of tires originally installed on your vehicle. Do not use it for tires that a different size than the original ones, or for any other purposes.
- If the sealant gets on your clothes, it may stain.
- If the sealant adheres to a wheel or the surface of the vehicle body, the stain may not be removable if it is not cleaned at once. Immediately wipe away the sealant with a wet cloth.
- During operation of the repair kit, a loud operation noise is produced. This does not indicate a malfunction.
- Do not use to check or to adjust the tire pressure.

⚠ WARNING

■ Caution while driving

- Store the repair kit in the luggage compartment. Injuries may result in the event of an accident or sudden braking.
- The repair kit is exclusively only for your vehicle. Do not use repair kit on other vehicles, which could lead to an accident causing death or serious injury.

⚠ WARNING

- Do not use repair kit for tires that are different size than the original ones, or for any other purpose. If the tires have not been completely repaired, it could lead to an accident causing death or serious injury.

■ Precautions for use of the sealant

- Ingesting the sealant is hazardous to your health. If you ingest sealant, consume as much water as possible, and then immediately consult a doctor.
- If sealant gets in eyes or adheres to skin, immediately wash it off with water. If discomfort persists, consult a doctor.

Taking out the emergency tire puncture repair kit

- 1 Lift the deck mat. (→P.321)
- 2 Take out the emergency tire puncture repair kit. (→P.310)

Emergency repair method

- 1 Take out the repair kit from the plastic bag.
- Attach the sticker enclosed with the bottle on the specified locations. (See step10.)

- 2 Pull out the hose and power plug from the bottom side of the compressor.

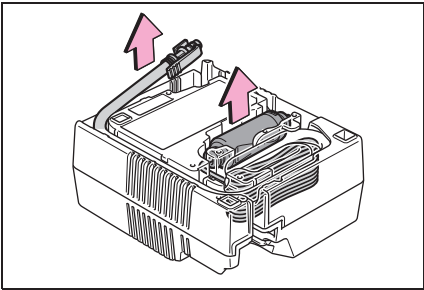

- 3 Connect the bottle to the compressor.

Make sure to press the bottle until its claws are securely engaged to the compressor and no longer visible.

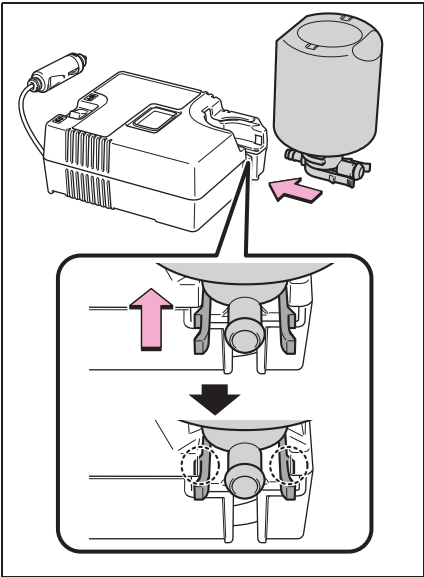

- 4 Connect the hose to the bottle. Make sure to insert the hose until its

claw is securely engaged to the bottle.

Therefore keep it in a safe place.

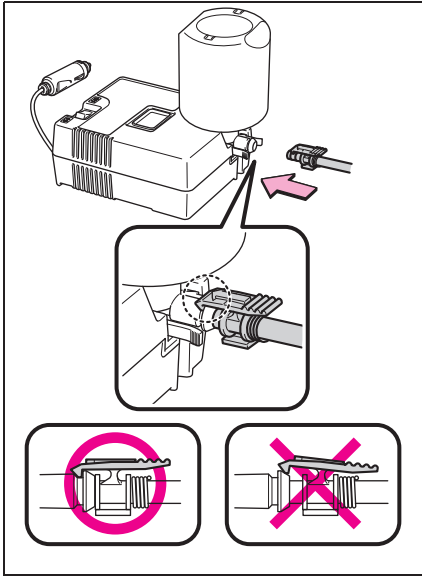

- 5** Remove the valve cap from the valve of the punctured tire.

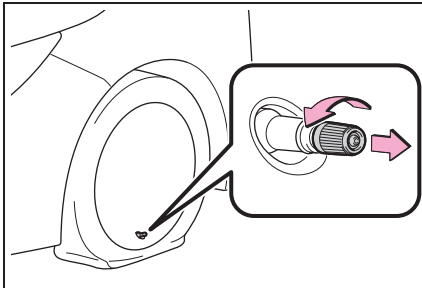

- 6** Extend the hose. Remove the air release cap from the hose. You will use the air release cap again.

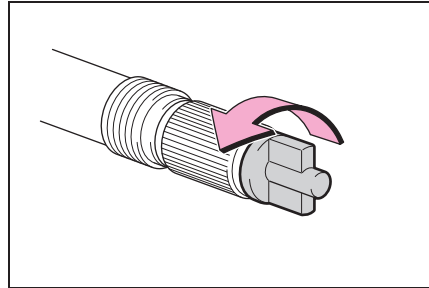

- 7** Connect the hose to the valve.

Screw the end of the hose clockwise as far as possible.

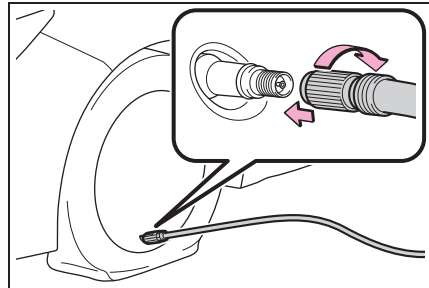

- 8** Remove the power plug from the compressor.

Make sure that the compressor switch is off.

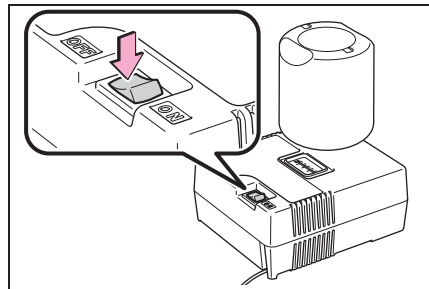

- 9 Connect the power plug to the power outlet socket. (→P.245)

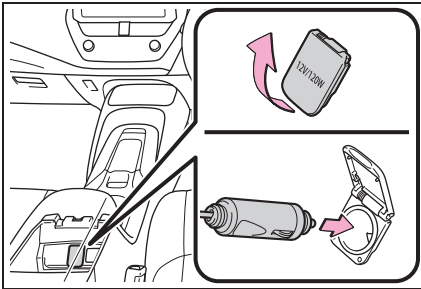

- 10 Attach the sticker provided with the tire puncture repair kit to a position easily seen from the driver's seat.

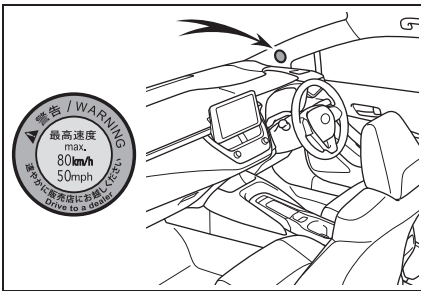

- 11 Check the specified tire inflation pressure.

Tire inflation pressure is specified on the label on the driver's side pillar as shown. (→P.343)

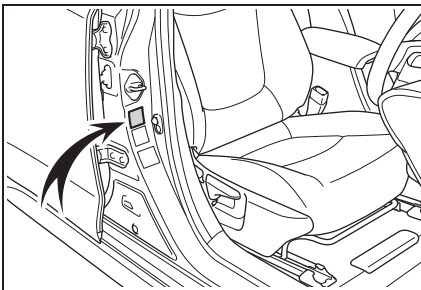

- 12 Start the hybrid system. (→P.140)

- 13 To inject the sealant and inflate the tire, turn the compressor switch on.

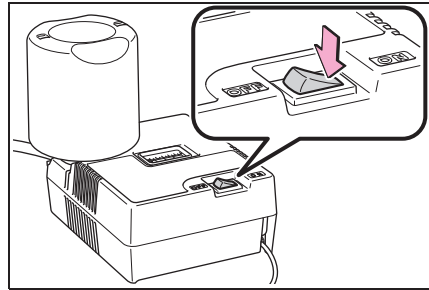

- 14 Inflate the tire until the specified air pressure is reached.

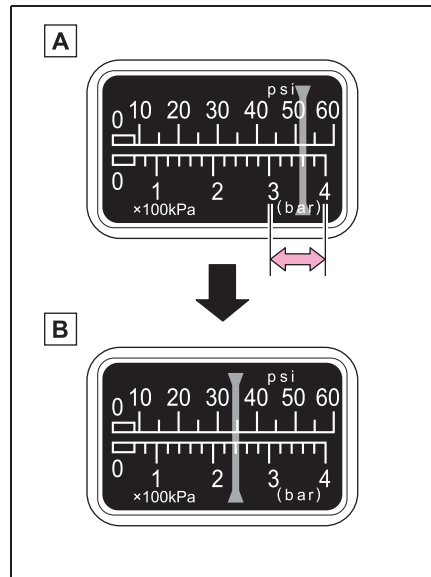

- A** The sealant will be injected and the pressure will spike to between 300 kPa (3.0 kgf/cm² or bar, 44 psi) and 400 kPa (4.0 kgf/cm² or bar, 58 psi), then gradually decrease.
- B** The air pressure gauge will display the actual tire inflation pres-

sure about 1 to 5 minutes after the switch is turned on.

Turn the compressor switch off and then check the tire inflation pressure. Being careful not to over inflate, check and repeat the inflation procedure until the specified tire inflation pressure is reached.

The tire can be inflated for about 5 to 20 minutes (depending on the outside temperature). If the tire inflation pressure is still lower than the specified point after inflation for 25 minutes, the tire is too damaged to be repaired. Turn the compressor switch off and contact your Toyota dealer.

If the tire inflation pressure exceeds the specified air pressure, let out some air to adjust the tire inflation pressure. (→P.316, 343)

15 With the compressor switch off, disconnect the hose from the valve on the tire and then pull out the power plug from the power outlet socket.

Some sealant may leak when the hose is removed.

16 Install the valve cap onto the valve of the emergency repaired tire.

17 Attach the air release cap to the end of the hose.

If the air release cap is not attached, the sealant may leak and the vehicle

may get dirty.

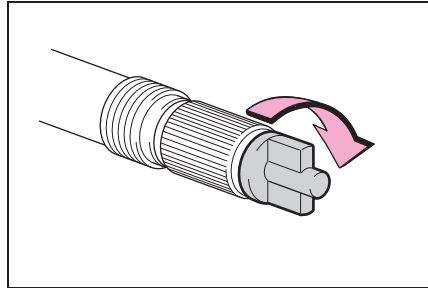

18 Temporarily store the bottle in the luggage compartment while it is connected to the compressor.

19 To spread the liquid sealant evenly within the tire, immediately drive safely for about 5 km (3 miles) below 80 km/h (50 mph).

20 After driving, stop your vehicle in a safe place on a hard, flat surface and reconnect the repair kit.

Remove the air release cap from the hose before reconnecting the hose.

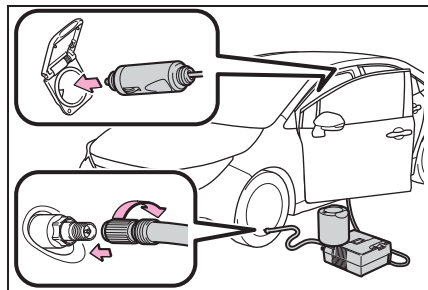

21 Turn the compressor switch on and wait for several seconds,

then turn it off. Check the tire inflation pressure.

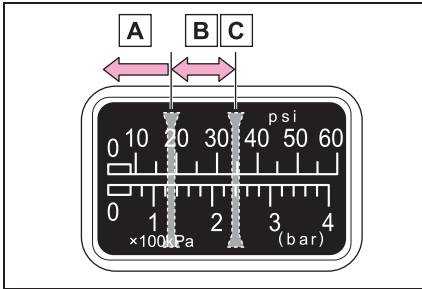

- A** If the tire inflation pressure is under 130 kPa (1.3 kgf/cm² or bar, 19 psi): The puncture cannot be repaired. Contact your Toyota dealer.
- B** If the tire inflation pressure is 130 kPa (1.3 kgf/cm² or bar, 19 psi) or higher, but less than the specified air pressure: Proceed to step **22**.
- C** If the tire inflation pressure is the specified air pressure (→P.343): Proceed to step **23**.

22 Turn the compressor switch on to inflate the tire until the specified air pressure is reached. Drive for about 5 km (3 miles) and then perform step **20**.

23 Attach the air release cap to the end of the hose.

If the air release cap is not attached, the sealant may leak and the vehicle

may get dirty.

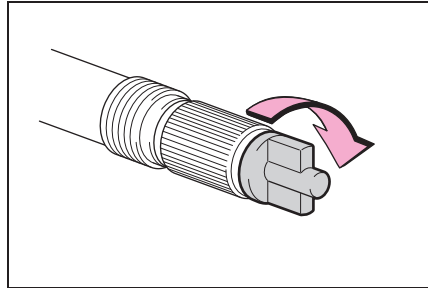

24 Store the bottle in the luggage compartment while it is connected to the compressor.

25 Taking precautions to avoid sudden braking, sudden acceleration and sharp turns, drive carefully at under 80 km/h (50 mph) to the nearest Toyota dealer that is less than 100 km (62 miles) away for tire repair or replacement.

When having the tire repaired or replaced, make sure to tell the Toyota dealer that the sealant is injected.

■ **If the tire is inflated to more than the specified air pressure**

- 1** Disconnect the hose from the valve.
- 2** Install the air release cap to the end of the hose and push the protrusion on the air release cap into the tire valve to let some air out.

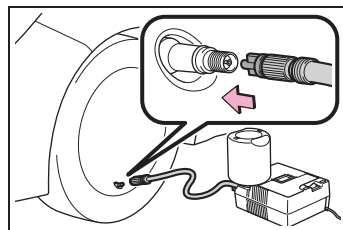

- 3** Disconnect the hose from the valve, remove the air release cap from the hose and then reconnect the hose.

- 4 Turn the compressor switch on and wait for several seconds, and then turn it off. Check that the air pressure indicator shows the specified air pressure. (→P.343)

If the air pressure is under the designated pressure, turn the compressor switch on again and repeat the inflation procedure until the specified air pressure is reached.

■ The valve of a tire that has been repaired

After a tire is repaired with the emergency tire puncture repair kit, the valve should be replaced.



WARNING

■ Do not drive the vehicle with a flat tire

Do not continue driving with a flat tire. Driving even a short distance with a flat tire can damage the tire and the wheel beyond repair.

Driving with a flat tire may cause a circumferential groove on the side wall. In such a case, the tire may explode when using a repair kit.

■ When fixing the flat tire

- Stop your vehicle in a safe and flat area.
- Do not touch the wheels or the area around the brakes immediately after the vehicle has been driven. After the vehicle has been driven, the wheels and the area around the brakes may be extremely hot. Touching these areas with hands, feet or other body parts may result in burns.
- Connect the valve and hose securely with the tire installed on the vehicle. If the hose is not properly connected to the valve, air leakage may occur as sealant may be sprayed out.

- If the hose comes off the valve while inflating the tire, there is a risk that the hose will move abruptly due to air pressure.

- After inflation of the tire has completed, the sealant may splatter when the hose is disconnected or some air is let out of the tire.

- Follow the operation procedure to repair the tire. If the procedures not followed, the sealant may spray out.

- Keep back from the tire while it is being repaired, as there is a chance of it bursting while the repair operation is being performed. If you notice any cracks or deformation of the tire, turn off the compressor switch and stop the repair operation immediately.

- The repair kit may overheat if operated for a long period of time. Do not operate the repair kit continuously for more than 40 minutes.

- Parts of the repair kit become hot during operation. Be careful when handling the repair kit during and after operation. Do not touch the metal part around the connecting area between the bottle and compressor. It will be extremely hot.

- Do not attach the vehicle speed warning sticker to an area other than the one indicated. If the sticker is attached to an area where an SRS airbag is located, such as the pad of the steering wheel, it may prevent the SRS airbag from operating properly.

■ Driving to spread the liquid sealant evenly

Observe the following precautions to reduce the risk of accidents. Failing to do so may result in a loss of vehicle control and cause death or serious injury.

**WARNING**

- Drive the vehicle carefully at a low speed. Be especially careful when turning and cornering.
- If the vehicle does not drive straight or you feel a pull through the steering wheel, stop the vehicle and check the following.
 - Tire condition. The tire may have separated from the wheel.
 - Tire inflation pressure. If the tire inflation pressure is 130 kPa (1.3 kgf/cm² or bar, 19 psi) or less, the tire may be severely damaged.

**NOTICE****■ When performing an emergency repair**

- A tire should only be repaired with the emergency tire puncture repair kit if the damage is caused by a sharp object such as nail or screw passing through the tire tread. Do not remove the sharp object from the tire. Removing the object may widen the opening and disenable emergency repair with the repair kit.
- The repair kit is not waterproof. Make sure that the repair kit is not exposed to water, such as when it is being used in the rain.
- Do not put the repair kit directly onto dusty ground such as sand at the side of the road. If the repair kit vacuums up dust etc., a malfunction may occur.
- Make sure to stand the kit with the bottle vertical. The kit cannot work properly if it is laid on its side.

■ Precautions for the emergency tire puncture repair kit

- The repair kit power source should be 12 V DC suitable for vehicle use. Do not connect the repair kit to any other source.
- If fuel splatters on the repair kit, the repair kit may deteriorate. Take care not to allow fuel to contact it.
- Place the repair kit in a storage to prevent it from being exposed to dirt or water.
- Store the repair kit in the tool tray under the deck mat out of reach of children.
- Do not disassemble or modify the repair kit. Do not subject parts such as the air pressure indicator to impacts. This may cause a malfunction.

If you have a flat tire (vehicles with a spare tire)

Your vehicle is equipped with a spare tire. The flat tire can be replaced with the spare tire.

For details about tires: →P.272



WARNING

■ If you have a flat tire

Do not continue driving with a flat tire. Driving even a short distance with a flat tire can damage the tire and the wheel beyond repair, which could result in an accident.

Before jacking up the vehicle

- Stop the vehicle in a safe place on a hard, flat surface.
- Set the parking brake.
- Shift the shift lever to P.
- Stop the hybrid system.
- Turn on the emergency flashers.

Location of the spare tire, jack and tools

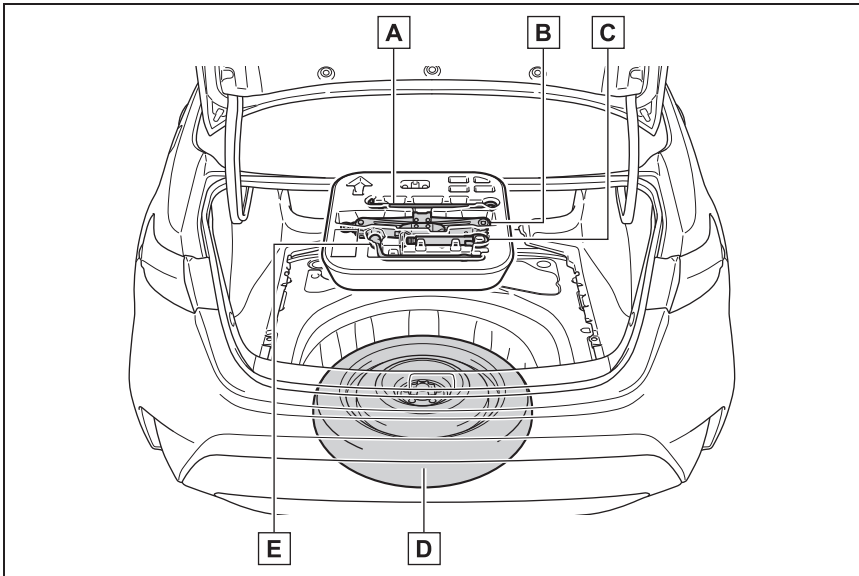

- A** Jack handle
- B** Jack
- C** Towing eyelet
- D** Spare tire
- E** Wheel nut wrench



WARNING

■ Using the tire jack

Observe the following precautions. Improper use of the tire jack may cause the vehicle to suddenly fall off the jack, leading to death or serious injury.

- Do not use the tire jack for any purpose other than replacing tires or installing and removing tire chains.
- Only use the tire jack that comes with this vehicle for replacing a flat tire. Do not use it on other vehicles, and do not use other tire jacks for replacing tires on this vehicle.

- Put the jack properly in its jack point.

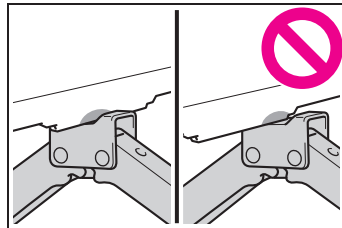

- Do not put any part of your body under the vehicle while it is supported by the jack.

WARNING

- Do not start the hybrid system or drive the vehicle while the vehicle is supported by the jack.
- Do not raise the vehicle while someone is inside.
- When raising the vehicle, do not put an object on or under the jack.
- Do not raise the vehicle to a height greater than that required to replace the tire.
- Use a jack stand if it is necessary to get under the vehicle.
- When lowering the vehicle, make sure that there is no-one near the vehicle. If there are people nearby, warn them vocally before lowering.

Taking out the jack

- 1 Remove the deck mat.

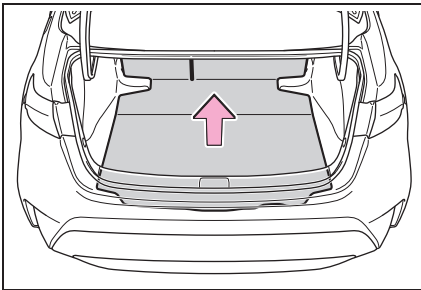

- 2 Take out the jack.

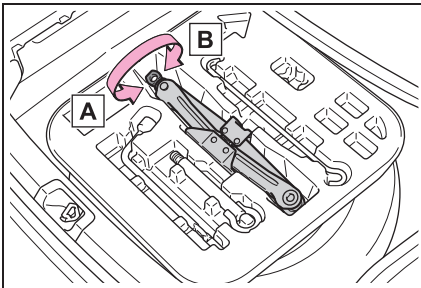

A For tightening

B For loosening

Taking out the spare tire

- 1 Remove the deck mat. (→P.321)
- 2 Remove the tool tray.

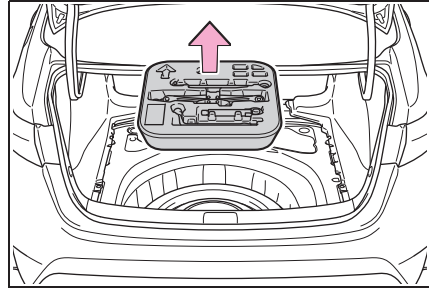

- 3 Loosen the center fastener that secures the spare tire.

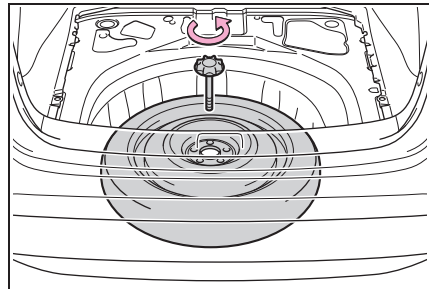

WARNING

■ When storing the spare tire

Be careful not to catch fingers or other body parts between the spare tire and the body of the vehicle.

Replacing a flat tire

- 1 Chock the tires.

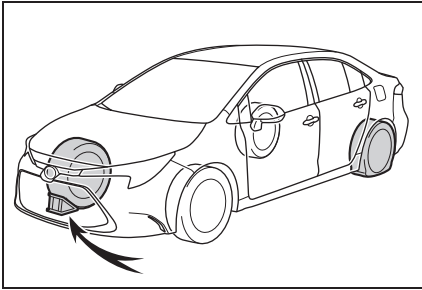

Flat tire	Wheel chock positions
Front left-hand side	Behind the rear right-hand side tire
Front right-hand side	Behind the rear left-hand side tire
Rear left-hand side	In front of the front right-hand side tire
Rear right-hand side	In front of the front left-hand side tire

- 2 Remove the wheel cap (if equipped) using the wrench.

Insert the wrench into the notch **A** on the wheel cap.
To protect the wheel cap, place a rag between the wrench and the wheel cap.

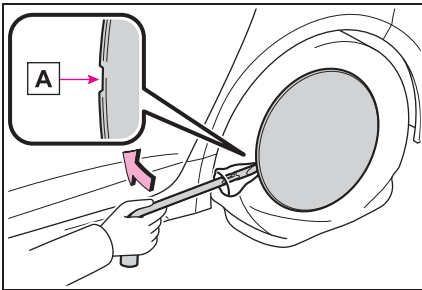

- 3 Slightly loosen the wheel nuts (one turn).

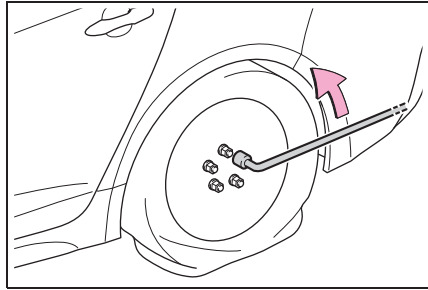

- 4 Turn the tire jack portion **A** by hand until the center of the recessed portion of the jack is in contact with the center of the jack point.

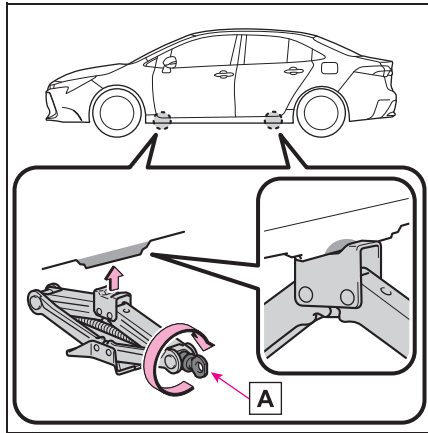

- 5 Assemble the jack handle extension.

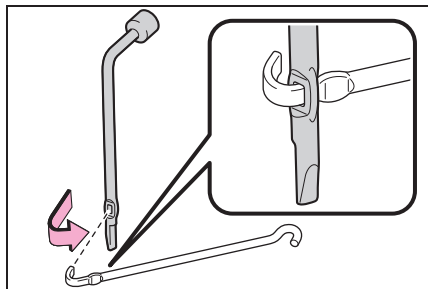

- 6 Raise the vehicle until the tire is slightly raised off the ground.

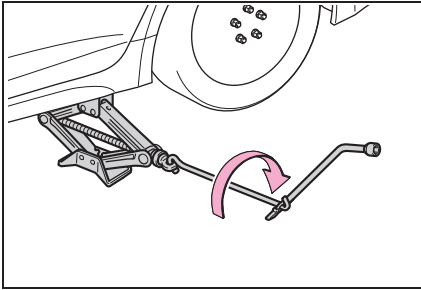

- 7 Remove all the wheel nuts and the tire.

When resting the tire on the ground, place the tire so that the wheel design faces up to avoid scratching the wheel surface.

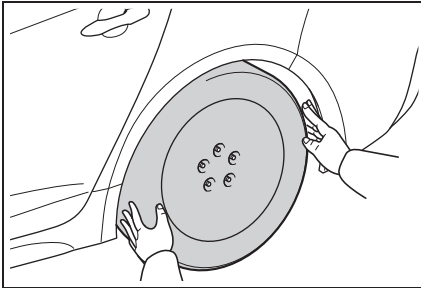

WARNING

■ Replacing a flat tire

- Do not touch the disc wheels or the area around the brakes immediately after the vehicle has been driven. After the vehicle has been driven the disc wheels and the area around the brakes will be extremely hot. Touching these areas with hands, feet or other body parts while changing a tire, etc. may result in burns.

- Failure to follow these precautions could cause the wheel nuts to loosen and the tire to fall off, resulting in death or serious injury.
- Have the wheel nuts tightened with a torque wrench to 103 N•m (10.5 kgf•m, 76 ft•lbf) as soon as possible after changing wheels.
- Do not attach a heavily damaged wheel ornament, as it may fly off the wheel while the vehicle is moving.
- When installing a tire, only use wheel nuts that have been specifically designed for that wheel.
- If there are any cracks or deformations in the bolt screws, nut threads or bolt holes of the wheel, have the vehicle inspected by your Toyota dealer.
- When installing the wheel nuts, be sure to install them with the tapered ends facing inward.

Installing the spare tire

- 1 Remove any dirt or foreign matter from the wheel contact surface.

If foreign matter is on the wheel contact surface, the wheel nuts may loosen while the vehicle is in motion, causing the tire to come off.

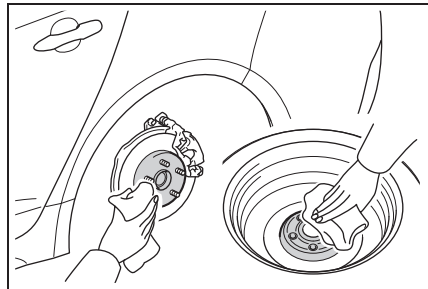

- 2 Install the tire and loosely tighten each wheel nut by hand

by approximately the same amount.

Tighten the wheel nuts until the tapered portion **A** comes into loose contact with the disc wheel seat **B**.

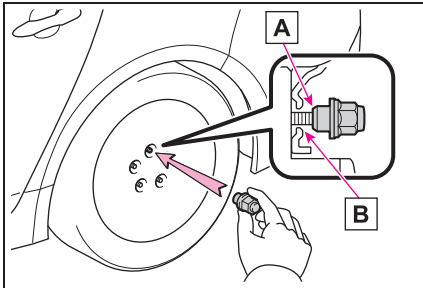

3 Lower the vehicle.

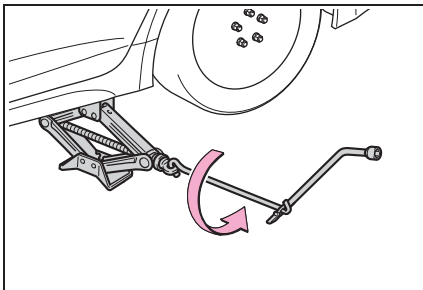

4 Firmly tighten each wheel nut two or three times in the order shown in the illustration.

Tightening torque:
103 N•m (10.5 kgf•m, 76 ft•lbf)

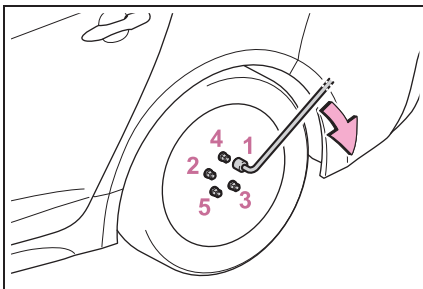

5 Stow the flat tire, tire jack and all tools.

■ **The compact spare tire**

● The compact spare tire is identified by the label “TEMPORARY USE ONLY” on the tire sidewall. Use the compact spare tire temporarily, and only in an emergency.

● Make sure to check the tire inflation pressure of the compact spare tire. (→P.343)

■ **When the compact spare tire is equipped**

The vehicle becomes lower when driving with the compact spare tire compared to when driving with standard tires.

■ **If you have a flat front tire on a road covered with snow or ice**

Install the compact spare tire on one of the rear wheels of the vehicle. Perform the following steps and fit tire chains to the front tires:

- 1 Replace a rear tire with the compact spare tire.
- 2 Replace the flat front tire with the tire removed from the rear of the vehicle.
- 3 Fit tire chains to the front tires.

■ **When reinstalling the wheel cap (except compact spare tire)**

Align the cutout of the wheel cap with the valve stem as shown in the illustration.

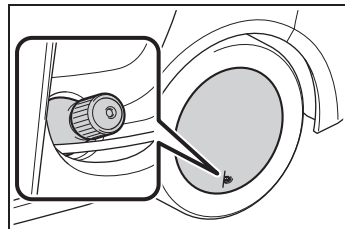

**WARNING****■ When using the compact spare tire**

- Remember that the compact spare tire provided is specifically designed for use with your vehicle. Do not use your compact spare tire on another vehicle.
- Do not use more than one compact spare tires simultaneously.
- Replace the compact spare tire with a standard tire as soon as possible.
- Avoid sudden acceleration, abrupt steering, sudden braking and shifting operations that cause sudden engine braking.

■ When the compact spare tire is attached

The vehicle speed may not be correctly detected, and the following systems may not operate correctly:

- ABS & Brake assist
- VSC
- TRC
- Automatic High Beam
- Dynamic radar cruise control
- EPS
- PCS (Pre-Collision System)
- LDA (Lane Departure Alert)
- LTA (Lane Tracing Assist)
- BSM (if equipped)
- RCTA (if equipped)
- SEA (if equipped)
- Rear view monitor system
- Navigation system (if equipped)

■ Speed limit when using the compact spare tire

Do not drive at speeds in excess of 80 km/h (50 mph) when a compact spare tire is installed on the vehicle.

The compact spare tire is not designed for driving at high speeds. Failure to observe this precaution may lead to an accident causing death or serious injury.

■ After using the tools and jack

Before driving, make sure all the tools and jack are securely in place in their storage location to reduce the possibility of personal injury during a collision or sudden braking.

**NOTICE****■ Be careful when driving over bumps with the compact spare tire installed on the vehicle**

The vehicle becomes lower when driving with the compact spare tire compared to when driving with standard tires. Be careful when driving over uneven road surfaces.

■ Driving with tire chains and the compact spare tire

- Temporary spare tires fitted to this vehicle must have a maximum load rating of not less than 750 kg or a load index of 98 and a speed category symbol of not less than M (130 km/h).
- Do not fit tire chains to the compact spare tire. Tire chains may damage the vehicle body and adversely affect driving performance.

If the hybrid system will not start

Reasons for the hybrid system not starting vary depending on the situation. Check the following and perform the appropriate procedure:

The hybrid system will not start even though the correct starting procedure is being followed. (→P.140)

One of the following may be the cause of the problem:

- The electronic key may not be functioning properly. (→P.328)
- There may not be sufficient fuel in the vehicle's tank. Refuel the vehicle.
- There may be a malfunction in the immobilizer system. (→P.66)
- The hybrid system may be malfunctioning due to an electrical problem such as electronic key battery depletion or a blown fuse. However, depending on the type of malfunction, an interim measure is available to start the hybrid system. (→P.326)

The interior lights and headlights are dim, or the horn does not sound or sounds at a low volume.

One of the following may be the cause of the problem:

- The 12-volt battery may be discharged. (→P.330)
- The 12-volt battery terminal connections may be loose or corroded. (→P.269)

The interior lights and headlights do not turn on, or the horn does not sound.

One of the following may be the cause of the problem:

- The 12-volt battery may be discharged. (→P.330)
- One or both of the 12-volt battery terminals may be disconnected. (→P.269)

Contact your Toyota dealer if the problem cannot be repaired, or if repair procedures are unknown.

Emergency start function

When the hybrid system does not start, the following steps can be used as an interim measure to start the hybrid system if the power switch is functioning normally. Do not use this starting procedure except in case of emergency.

- 1 Set the parking brake. (→P.149)

- 2 Check that the shift lever is in P.
- 3 Turn the power switch to ACC*.
- 4 Press and hold the power switch for about 15 seconds while depressing the brake pedal firmly.

Even if the hybrid system can be started using the above steps, the system may be malfunctioning. Have the vehicle inspected by your Toyota dealer.

*: ACC mode can be enabled/disabled on the customize menu. (→P.346)

If you lose your keys

New genuine keys can be made by your Toyota dealer using another mechanical key and the key number stamped on your key number plate.

Keep the plate in a safe place such as your wallet, not in the vehicle.



NOTICE

■ **When an electronic key is lost**

If the electronic key remains lost, the risk of vehicle theft increases significantly. Visit your Toyota dealer immediately with all remaining electronic keys that were provided with your vehicle.

If the electronic key does not operate properly

If communication between the electronic key and vehicle is interrupted (→P.113) or the electronic key cannot be used because the battery is depleted, the smart entry & start system and wireless remote control cannot be used. In such cases, the doors can be opened and the hybrid system can be started by following the procedure below.

■ When the electronic key does not work properly

- Make sure that the smart entry & start system has not been deactivated in the customization setting. If it is off, turn the function on. (Customizable features: →P.346)
- Check if battery-saving mode is set. If it is set, cancel the function. (→P.113)
- The electronic key function may be suspended. (→P.102)



NOTICE

■ In case of a smart entry & start system malfunction or other key-related problems

Take your vehicle with all the electronic keys provided with your vehicle to your Toyota dealer.

Locking and unlocking the doors

Use the mechanical key (→P.104)

in order to perform the following operations:

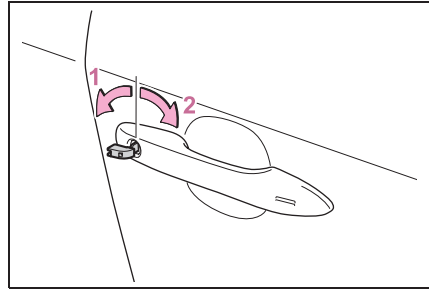

1 Unlocks all the doors

Turning the key unlocks the driver's door. Turning the key again unlocks the other doors.*

2 Locks all the doors

*: This setting must be customized at your Toyota dealer.

■ Key linked functions

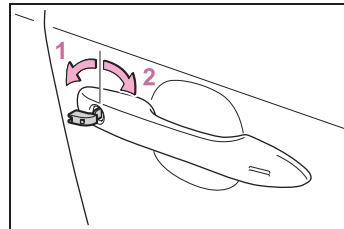

1 Opens the windows and moon roof*¹ (turn and hold)*²

2 Closes the windows and moon roof*¹ (turn and hold)*²

*¹: If equipped

*²: This setting must be customized at your Toyota dealer.

**WARNING**

■ **When using the mechanical key and operating the power windows**

Operate the power window after checking to make sure that there is no possibility of any passenger having any of their body parts caught in the window.

Also, do not allow children to operate the mechanical key. It is possible for children and other passengers to get caught in the power window.

Starting the hybrid system

- 1 Ensure that the shift lever is in P and depress the brake pedal.
- 2 Touch the electronic key to the power switch.

When the electronic key is detected, a buzzer sounds and the power switch will turn to ON.

When the smart entry & start system is deactivated in customization setting, the power switch will turn to ACC.

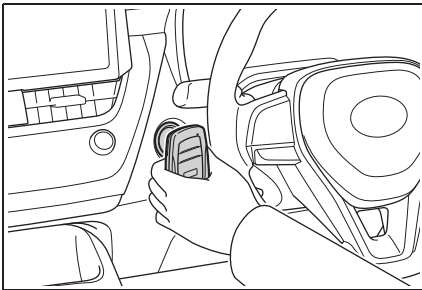

- 3 Firmly depress the brake pedal and check that  is shown on the multi-information display.
- 4 Press the power switch shortly and firmly.

In the event that the hybrid system

still cannot be started, contact your Toyota dealer.

■ Stopping the hybrid system

Shift the shift lever to P and press the power switch as you normally do when stopping the hybrid system.

■ Electronic key battery

As the above procedure is a temporary measure, it is recommended that the electronic key battery be replaced immediately when the battery is depleted. (→P.281)

■ Changing power switch modes

Release the brake pedal and press the power switch in step 3 above. The hybrid system does not start and modes will be changed each time the switch is pressed. (→P.142)

If the 12-volt battery is discharged

The following procedures may be used to start the hybrid system if the 12-volt battery is discharged.

You can also call your Toyota dealer or a qualified repair shop.

Restarting the hybrid system

If you have a set of jumper (or booster) cables and a second vehicle with a 12-volt battery, you can jump start your vehicle by following the steps below.

- 1 Open the hood. (→P.264)
- 2 Connect a positive jumper cable clamp to **A** on your vehicle and connect the clamp on the other end of the positive cable to **B** on the second vehicle. Then, connect a negative cable clamp to **C** on the second vehicle and connect the clamp at the other end of the negative cable to **D**.

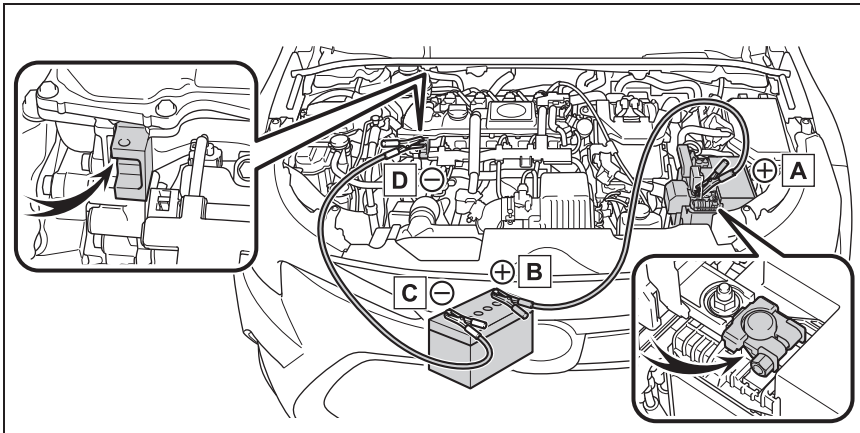

- A** Positive (+) battery terminal (your vehicle)
 - B** Positive (+) battery terminal (second vehicle)
 - C** Negative (-) battery terminal (second vehicle)
 - D** Solid, stationary, unpainted metallic point away from the battery and any moving parts as shown in the illustration
- 3 Start the engine of the second vehicle. Increase the engine speed slightly and maintain at that level for approximately 5 minutes to recharge the 12-volt battery of your vehicle.

- 4 Open and close any of the doors of your vehicle with the power switch OFF.
- 5 Maintain the engine speed of the second vehicle and start the hybrid system of your vehicle by turning the power switch to ON.
- 6 Make sure the “READY” indicator comes on. If the indicator does not come on, contact your Toyota dealer.
- 7 Once the hybrid system has started, remove the jumper cables in the exact reverse order from which they were connected.

Once the hybrid system starts, have the vehicle inspected at your Toyota dealer as soon as possible.

■ Starting the hybrid system when the 12-volt battery is discharged

The hybrid system cannot be started by push-starting.

■ To prevent 12-volt battery discharge

- Turn off the headlights and the audio system while the hybrid system is off.
- Turn off any unnecessary electrical components when the vehicle is running at a low speed for an extended period, such as in heavy traffic.

■ When the 12-volt battery is removed or discharged

Information stored in the ECU is cleared. When the 12-volt battery is depleted, have the vehicle inspected at your Toyota dealer.

■ When removing the 12-volt battery terminals

When the 12-volt battery terminals are

removed, the information stored in the ECU is cleared. Before removing the 12-volt battery terminals, contact your Toyota dealer.

■ Charging the 12-volt battery

The electricity stored in the 12-volt battery will discharge gradually even when the vehicle is not in use, due to natural discharge and the draining effects of certain electrical appliances. If the vehicle is left for a long time, the 12-volt battery may discharge, and the hybrid system may be unable to start. (The 12-volt battery recharges automatically while the hybrid system is operating.)

■ When recharging or replacing the 12-volt battery

- In some cases, it may not be possible to unlock the doors using the smart entry & start system when the 12-volt battery is discharged. Use the wireless remote control or the mechanical key to lock or unlock the doors.
 - The hybrid system may not start on the first attempt after the 12-volt battery has recharged but will start normally after the second attempt. This is not a malfunction.
 - The power switch mode is memorized by the vehicle. When the 12-volt battery is reconnected, the system will return to the mode it was in before the 12-volt battery was discharged. Before disconnecting the 12-volt battery, turn the power switch off. If you are unsure what mode the power switch was in before the 12-volt battery discharged, be especially careful when reconnecting the 12-volt battery.
- #### ■ When replacing the 12-volt battery
- Use a 12-volt battery that conforms to European regulations.
 - Use a 12-volt battery that the case size is same as the previous one (LN1), 20 hour rate capacity (20HR) is equivalent (45Ah) or greater, and performance rating (CCA) is equivalent (295A) or greater.

- If the sizes differ, the 12-volt battery cannot be properly secured.
- If the 20 hour rate capacity is low, even if the time period where the vehicle is not used is a short time, the 12-volt battery may discharge and the hybrid system may not be able to start.
- For details, consult your Toyota dealer.



WARNING

■ When removing the 12-volt battery terminals

Always remove the negative (-) terminal first. If the positive (+) terminal contacts any metal in the surrounding area when the positive (+) terminal is removed, a spark may occur, leading to a fire in addition to electrical shocks and death or serious injury.

■ Avoiding 12-volt battery fires or explosions

Observe the following precautions to prevent accidentally igniting the flammable gas that may be emitted from the 12-volt battery:

- Make sure each jumper cable is connected to the correct terminal and that it is not unintentionally in contact with any other than the intended terminal.
- Do not allow the other end of the jumper cable connected to the “+” terminal to come into contact with any other parts or metal surfaces in the area, such as brackets or unpainted metal.
- Do not allow the + and - clamps of the jumper cables to come into contact with each other.
- Do not smoke, use matches, cigarette lighters or allow open flame near the 12-volt battery.

■ 12-volt battery precautions

The 12-volt battery contains poisonous and corrosive acidic electrolyte, while related parts contain lead and lead compounds. Observe the following precautions when handling the 12-volt battery:

- When working with the 12-volt battery, always wear safety glasses and take care not to allow any battery fluids (acid) to come into contact with skin, clothing or the vehicle body.
- Do not lean over the 12-volt battery.
- In the event that battery fluid comes into contact with the skin or eyes, immediately wash the affected area with water and seek medical attention. Place a wet sponge or cloth over the affected area until medical attention can be received.
- Always wash your hands after handling the 12-volt battery support, terminals, and other battery-related parts.
- Do not allow children near the 12-volt battery.



NOTICE

■ When handling jumper cables

When connecting the jumper cables, ensure that they do not become entangled in the cooling fans, etc.

If your vehicle overheats

The following may indicate that your vehicle is overheating.

- The engine coolant temperature gauge (→P.72, 75) is in the red zone or a loss of hybrid system power is experienced. (For example, the vehicle speed does not increase.)
- “Engine Coolant Temp High Stop in a Safe Place See Owner’s Manual” or “Hybrid System Overheated Output Power Reduced” is shown on the multi-information display.
- Steam comes out from under the hood.

Correction procedures

- ▶ If the engine coolant temperature gauge enters the red zone or “Engine Coolant Temp High Stop in a Safe Place See Owner’s Manual” is shown on the multi-information display
- 1 Stop the vehicle in a safe place and turn off the air conditioning system, and then stop the hybrid system.
 - 2 If you see steam: Carefully lift the hood after the steam subsides.
If you do not see steam: Carefully lift the hood.

- 3 After the hybrid system has cooled down sufficiently, inspect the hoses and radiator core (radiator) for any leaks.

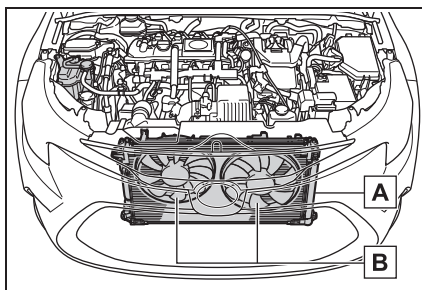

- A** Radiator
- B** Cooling fans

If a large amount of coolant leaks, immediately contact your Toyota dealer.

- 4 The coolant level is satisfactory if it is between the “MAX” and “MIN” lines on the reservoir.

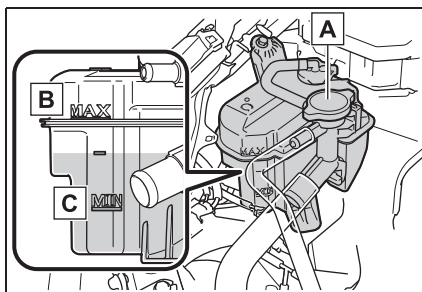

- A** Reservoir
- B** “MAX” line
- C** “MIN” line

- 5 Add coolant if necessary.

Water can be used in an emergency if

coolant is unavailable.

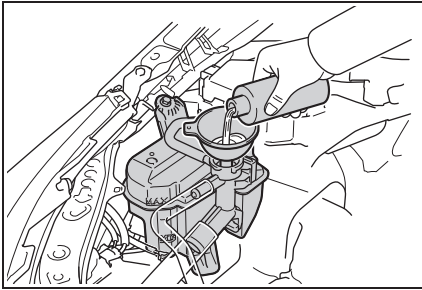

- 6** Start the hybrid system and turn the air conditioning system on to check that the radiator cooling fans operate and to check for coolant leaks from the radiator or hoses.

The fans operate when the air conditioning system is turned on immediately after a cold start. Confirm that the fans are operating by checking the fan sound and air flow. If it is difficult to check these, turn the air conditioning system on and off repeatedly. (The fans may not operate in freezing temperatures.)

- 7** If the fans are not operating: Stop the hybrid system immediately and contact your Toyota dealer.
 If the fans are operating: Have the vehicle inspected at the nearest Toyota dealer.

- ▶ If “Hybrid System Overheated Output Power Reduced” is shown on the multi-information display
- 1** Stop the vehicle in a safe place.
- 2** Stop the hybrid system and carefully lift the hood.

- 3** After the hybrid system has cooled down, inspect the hoses and radiator core (radiator) for any leaks.

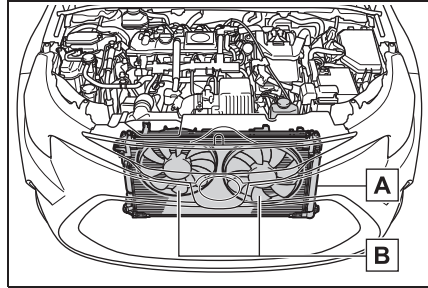

- A** Radiator
- B** Cooling fans

If a large amount of coolant leaks, immediately contact your Toyota dealer.

- 4** The coolant level is satisfactory if it is between the “MAX” and “MIN” lines on the reservoir.

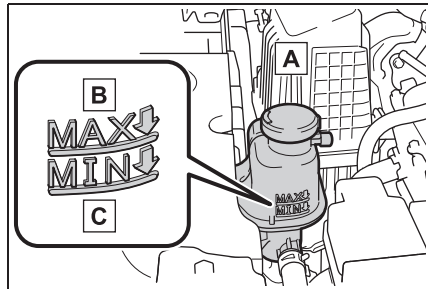

- A** Reservoir
- B** “MAX” line
- C** “MIN” line

- 5** Add coolant if necessary.

If coolant is unavailable, use water as an emergency measure, and have the vehicle inspected at your Toyota dealer

as soon as possible.

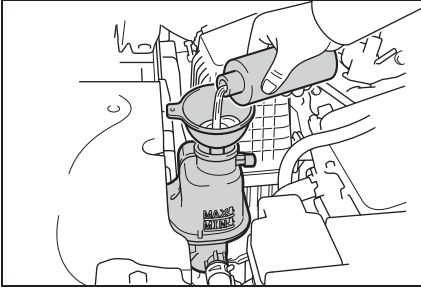

- 6** After stopping the hybrid system and waiting for 5 minutes or more, start the hybrid system again and check for the multi-information display.

If the message does not disappear: Stop the hybrid system and contact your Toyota dealer. If the message is not displayed: The hybrid system temperature has dropped and the vehicle may be driven normally.

However, if the message appears again frequently, contact your Toyota dealer.



WARNING

■ When inspecting under the hood of your vehicle

Observe the following precautions. Failure to do so may result in serious injury such as burns.

- If steam is seen coming from under the hood, do not open the hood until the steam has subsided. The engine compartment may be very hot.

- After the hybrid system has been turned off, check that the “READY” indicator is off. When the hybrid system is operating, the gasoline engine may automatically start, or the cooling fans may suddenly operate even if the gasoline engine stops. Do not touch or approach rotating parts such as the fan, which may lead to fingers or clothing (especially a tie, a scarf or a muffler) getting caught, resulting in serious injury.

- Do not loosen the coolant reservoir caps while the hybrid system and radiator are hot. High temperature steam or coolant could spray out.



NOTICE

■ When adding engine/power control unit coolant

Add coolant slowly after the hybrid system has cooled down sufficiently. Adding cool coolant to a hot hybrid system too quickly can cause damage to the hybrid system.

■ To prevent damage to the cooling system

Observe the following precautions:

- Avoid contaminating the coolant with foreign matter (such as sand or dust etc.).
- Do not use any coolant additive.

If the vehicle becomes stuck

Carry out the following procedures if the tires spin or the vehicle becomes stuck in mud, dirt or snow:

Recovering procedure

- 1 Stop the hybrid system. Set the parking brake and shift the shift lever to P.
- 2 Remove the mud, snow or sand from around the front wheels.
- 3 Place wood, stones or some other material under the front wheels to help provide traction.
- 4 Restart the hybrid system.
- 5 Shift the shift lever to D or R and release the parking brake. Then, while exercising caution, depress the accelerator pedal.

When it is difficult to free the vehicle

Press the  switch to turn off TRC.

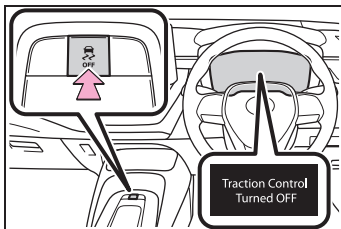

WARNING

When attempting to free a stuck vehicle

If you choose to push the vehicle back and forth to free it, make sure the surrounding area is clear to avoid striking other vehicles, objects or people. The vehicle may also lunge forward or lunge back suddenly as it becomes free. Use extreme caution.

When shifting the shift lever

Be careful not to shift the shift lever with the accelerator pedal depressed. This may lead to unexpected rapid acceleration of the vehicle that may cause an accident resulting in death or serious injury.

NOTICE

To avoid damaging the transmission and other components

- Avoid spinning the front wheels and depressing the accelerator pedal more than necessary.
- If the vehicle remains stuck even after these procedures are performed, the vehicle may require towing to be freed.

Vehicle specifications

8

8-1. Specifications

Maintenance data (fuel, oil level, etc.)**338**

Fuel information**345**

8-2. Customization

Customizable features**346**

Maintenance data (fuel, oil level, etc.)

Dimensions

Overall length	4630 mm (182.3 in.)	
Overall width	1780 mm (70.1 in.)	
Overall height*	1435 mm (56.5 in.)	
Wheelbase	2700 mm (106.3 in.)	
Tread	Front	1531 mm (60.3 in.)
	Rear	1534 mm (60.4 in.)

*: Unladen vehicles

Vehicle identification

■ Vehicle identification number

The vehicle identification number (VIN) is the legal identifier for your vehicle. This is the primary identification number for your Toyota. It is used in registering the ownership of your vehicle.

This number is stamped under the right-hand front seat.

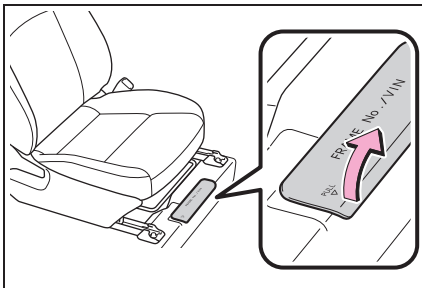

This number is also on the manufacturer's label.

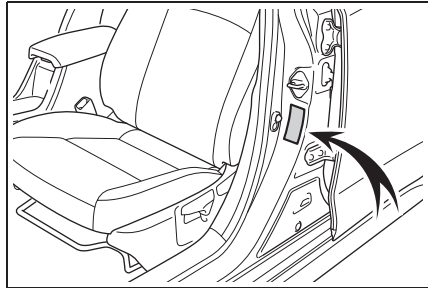

■ Engine number

The engine number is stamped on the engine block as shown.

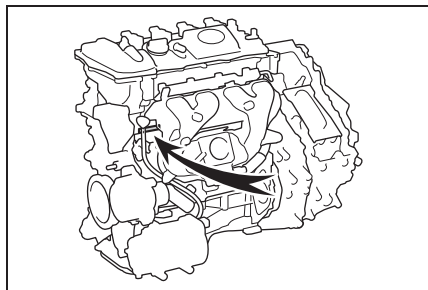

Engine

Model	2ZR-FXE
Type	4-cylinder in line, 4-cycle, gasoline
Bore and stroke	80.5 × 88.3 mm (3.17 × 3.48 in.)
Displacement	1798 cm ³ (109.7 cu. in.)
Valve clearance	Automatic adjustment

Fuel

Fuel type	Unleaded gasoline only
Research Octane Number	91 or higher
Fuel tank capacity (Reference)	43.0 L (11.4 gal., 9.5 Imp. gal.)

Electric motor (traction motor)

Type	Permanent magnet synchronous motor
Maximum output	70 kW
Maximum torque	185 N•m (18.9 kgf•m, 136.4 ft•lbf)

Hybrid battery (traction battery)

Type	Lithium-ion battery
Voltage	3.7 V/cell
Capacity	4.08 Ah
Quantity	56 cells
Nominal voltage	207.2 V

Lubrication system

■ Oil capacity (Drain and refill [Reference*])

With filter	4.2 L (4.4 qt., 3.7 Imp. qt.)
Without filter	3.9 L (4.1 qt., 3.4 Imp. qt.)

*: The engine oil capacity is a reference quantity to be used when changing the engine oil. Warm up the engine

and turn off the hybrid system, wait more than 5 minutes, and check the oil level on the dipstick.

■ Engine oil selection

“Toyota Genuine Motor Oil” is used in your Toyota vehicle. Use Toyota approved “Toyota Genuine Motor Oil” or equivalent to satisfy the following grade and viscosity.

Oil grade:

0W-16:

API grade SN “Resource-Conserving”, SN PLUS “Resource-Conserving” or SP “Resource-Conserving” ; or ILSAC GF-6B multigrade engine oil

0W-20, 5W-20, 5W-30 and 10W-30:

API grade SL “Energy-Conserving”, SM “Energy-Conserving”, SN “Resource-Conserving”, SN PLUS “Resource-Conserving” or SP “Resource-Conserving” ; or ILSAC GF-6A multigrade engine oil

Recommended viscosity (SAE):

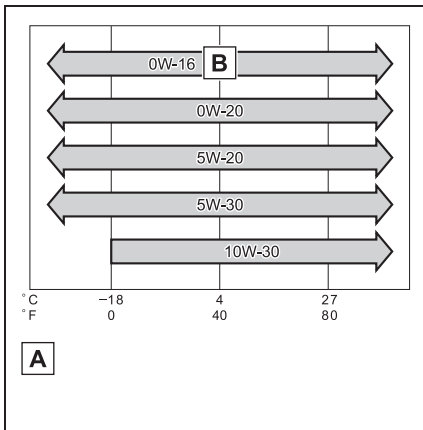

A Temperature range anticipated before next oil change

B Preferred

SAE 0W-16 is filled into your Toyota vehicle at manufacturing, and the best choice for good fuel economy and good starting in cold weather.

If you use SAE 10W-30 or a higher viscosity engine oil in extremely low temperatures, the engine may become difficult to start, so SAE 0W-16, 0W-20, 5W-20 or 5W-30 engine oil is recommended.

Oil viscosity (0W-16 is explained here as an example):

- The 0W in 0W-16 indicates the characteristic of the oil which allows cold startability. Oils with a lower value before the W allow for easier starting of the engine in cold weather.
- The 16 in 0W-16 indicates the viscosity characteristic of the oil when the oil is at high temperature. An oil with a higher viscosity (one with a higher value) may be better suited if the vehicle is operated at high speeds, or under extreme load conditions.

How to read oil container labels:

Either or both API registered marks are added to some oil containers to help you select the oil you should use.

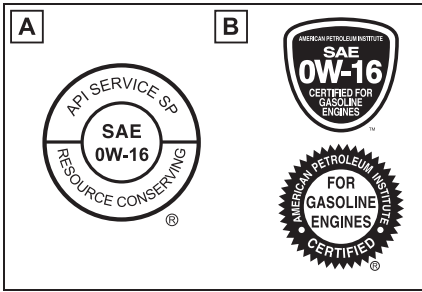

A API Service Symbol

Top portion: “API SERVICE SP” means the oil quality designation by American

Petroleum Institute (API).

Center portion: “SAE 0W-16” means the SAE viscosity grade.

Lower portion: “Resource-Conserving” means that the oil has fuel-saving and environmental protection capabilities.

B ILSAC Certification Mark

The International Lubricant Specification Advisory Committee (ILSAC) Certification Mark is displayed on the front of the container.

Cooling system

Capacity (Reference)	Gasoline engine	5.6 L (5.9 qt., 4.9 Imp. qt.)
	Power control unit	1.5 L (1.6 qt., 1.3 Imp. qt.)
Coolant type	Use either of the following: <ul style="list-style-type: none"> • “Toyota Super Long Life Coolant” • Similar high-quality ethylene glycol-based non-silicate, non-amine, non-nitrite, and non-borate coolant with long-life hybrid organic acid technology Do not use plain water alone.	

Ignition system (spark plug)

Make	DENSO FC16HR-CY9
Gap	0.9 mm (0.035 in.)



NOTICE

■ Iridium-tipped spark plugs

Use only iridium-tipped spark plugs. Do not adjust the spark plug gap.

Electrical system (12-volt battery)

Open voltage at 20°C (68°F):	12.0 V or higher (Turn the power switch off and turn on the high beam headlights for 30 seconds.)
Specific gravity reading at 20°C (68°F):	1.25 or higher If the specific gravity is lower than the standard value, charge the battery.
Charging rates	
Quick charge	15 A max.
Slow charge	5 A max.

Hybrid transmission

Fluid capacity*	3.0 L (3.1 qt., 2.6 Imp. qt.)
Fluid type	Toyota Genuine e-Transaxle fluid TE

*: The fluid capacity is a reference quantity.
If replacement is necessary, contact your Toyota dealer.



NOTICE

Hybrid transmission fluid type

Using transmission fluid other than the above type may cause abnormal noise or vibration, or ultimately damage the transmission of your vehicle.

Brakes

Pedal clearance* ¹	103 mm (4.1 in.) Min.
Pedal free play	1 — 6 mm (0.04 — 0.24 in.)
Parking brake indicator* ²	When pulling the parking brake switch for 1 to 2 seconds: comes on When pushing the parking brake switch for 1 to 2 seconds: turns off
Fluid type	FMVSS No.116 DOT 3 or SAE J1703 FMVSS No.116 DOT 4 or SAE J1704

*¹: Minimum pedal clearance when depressed with a force of 300 N (30.6 kgf, 67.4 lbf) while the hybrid system is operating.

*²: Make sure to confirm that the brake warning light (yellow) does not illuminate. (If

the brake warning light illuminates, refer to P.298.)

Steering

Free play	Less than 30 mm (1.2 in.)
-----------	---------------------------

Tires and wheels

► 16-inch tires

Tire size	205/55R16 91V
Tire inflation pressure (Recommended cold tire inflation pressure)	► Front wheel 250 kPa (2.5 kgf/cm ² or bar, 36 psi) ► Rear wheel 240 kPa (2.4 kgf/cm ² or bar, 35 psi)
Wheel size	16 × 7J
Wheel nut torque	103 N•m (10.5 kgf•m, 76 ft•lbf)

► 18-inch tires

Tire size	225/40R18 88W		
Tire inflation pressure (Recommended cold tire inflation pressure)	Vehicle speed	Front wheel kPa (kgf/cm ² or bar, psi)	Rear wheel kPa (kgf/cm ² or bar, psi)
	More than 160 km/h (100 mph)	260 (2.6, 38)	240 (2.4, 35)
	160 km/h (100 mph) or less	230 (2.3, 33)	210 (2.1, 30)
Wheel size	18 × 8J		
Wheel nut torque	103 N•m (10.5 kgf•m, 76 ft•lbf)		

► Compact spare tire (if equipped)

Tire size	T125/70D17 98M
Tire inflation pressure (Recommended cold tire inflation pressure)	420 kPa (4.2 kgf/cm ² or bar, 60 psi)
Wheel size	17 × 4T
Wheel nut torque	103 N•m (10.5 kgf•m, 76 ft•lbf)

Light bulbs

	Light bulbs	W	Type
Exterior	Rear turn signal lights	21	B
	Back-up light	16	A
Interior	Trunk light	5	A

A: Wedge base bulbs (clear)

B: Wedge base bulbs (amber)

Fuel information

You must only use unleaded gasoline.

Select unleaded gasoline with a Research Octane Number of 91 or higher for optimum engine performance.

■ Use of ethanol blended gasoline in a gasoline engine

Toyota allows the use of ethanol blended gasoline where the ethanol content is up to 10%. Make sure that the ethanol blended gasoline to be used has a Research Octane Number that follows the above.

■ If your engine knocks

- Consult your Toyota dealer.
- You may occasionally notice light knocking for a short time while accelerating or driving uphill. This is normal and there is no need for concern.



NOTICE

■ Notice on fuel quality

- Do not use improper fuels. If improper fuels are used, the engine will be damaged.
- Do not use gasoline with metallic additives, for example manganese, iron or lead, otherwise it may cause damage on your engine or emission control system.
- Do not add aftermarket fuel additives which contain metallic additives.
- Do not use the methanol blended gasoline such as M15, M85, M100. The use of gasoline containing methanol may cause engine damage or failure.



Customizable features

Your vehicle includes a variety of electronic features that can be personalized to suit your preferences. The settings of these features can be changed using the multi-information display, the audio system screen, or at your Toyota dealer.

Customizing vehicle features

■ Changing by using the audio system screen

- 1 Select  on the main menu.
- 2 Select "Vehicle customise".
- 3 Select the item to change the settings of from the list.

For functions that can be turned on/off, select  (ON)/  (OFF).

■ Changing by using the meter control switches



- 1 Select  of the multi-information display.



Customizable features

Some function settings are changed simultaneously with other functions being customized. Contact your Toyota dealer for further details.

- A** Settings that can be changed using the audio system screen
- B** Settings that can be changed using the meter control switches
- C** Settings that can be changed by your Toyota dealer

Definition of symbols: O = Available, — = Not available

7-inch display meter: Press  or  to select the desired item to be customized.

12.3-inch display meter: Press  or  to select the desired item to be customized.

2 Press or press and hold OK .

The available settings will differ depending on if OK is pressed or pressed and held. Follow the instructions on the display.

WARNING

■ During customization

As the hybrid system needs to be operating during customization, ensure that the vehicle is parked in a place with adequate ventilation. In a closed area such as a garage, exhaust gases including harmful carbon monoxide (CO) may collect and enter the vehicle. This may lead to death or a serious health hazard.

NOTICE

■ During customization

To prevent 12-volt battery discharge, ensure that the hybrid system is operating while customizing features.

■ Gauges, meters and multi-information display (→P.68, 72, 75, 80, 86)

Function*1	Default setting	Customized setting	A	B	C
Language	English	French	—	O	—
		Spanish*2			
		Brazilian Portuguese*2			
Units	L/100 km	km/L	—	O	—
Meter Type*3	2-dial	1-dial	—	O	—
		non-dial			
Meter Style*3	Smart	Casual	—	O	—
		Tough			
		Sporty			
Meter Style*4	Smart	Casual	—	O	—
		Sporty			
Dial Type*5	Speedometer	Hybrid System Indicator	—	O	—
		Tachometer			
Dial Type*6	Hybrid System Indicator	Tachometer	—	O	—
Dial Type*4	Hybrid System Indicator	Tachometer	—	O	—
		Simple (non-dial)			
EV indicator	On	Off	—	O	—
Fuel economy	Total average (Average fuel consumption [after reset])	Trip average (Average fuel consumption [after start])	—	O	—
		Tank average (Average fuel consumption [after refuel]) ^{*4}			
Eco Accelerator Guidance	On	Off	—	O	—
Drive information items (First item)	Distance	Average vehicle speed	—	O	—
		Elapsed time			

Function ^{*1}	Default setting	Customized setting	A	B	C
Drive information items (Second item)	Elapsed time	Distance	—	○	—
		Average vehicle speed			
TRIP A Items (First item) ^{*3}	Distance	Average vehicle speed	—	○	—
		Elapsed time			
TRIP A Items (Second item) ^{*3}	Average vehicle speed	Distance	—	○	—
		Elapsed time			
TRIP B Items (First item) ^{*3}	Distance	Average vehicle speed	—	○	—
		Elapsed time			
TRIP B Items (Second item) ^{*3}	Average vehicle speed	Distance	—	○	—
		Elapsed time			
Pop-up display	On	Off	—	○	—

*1: For details about each function: →P.80, 86

*2: If equipped

*3: 12.3-inch display

*4: 7-inch display

*5: 12.3-inch display when 1-dial display is selected

*6: 12.3-inch display when 2-dial display is selected

■ **Head-up display*** (→P.93)

Function	Default setting	Customized setting	A	B	C
Head-up display	On	Off	—	○	—
Gauge information	Hybrid System Indicator	Tachometer	—	○	—
		No content			
Route guidance to destination/street name*	On	Off	—	○	—
Driving support system display	On	Off	—	○	—

Function	Default setting	Customized setting	A	B	C
Compass*	On	Off	—	○	—
Audio system operation status	On	Off	—	○	—

*: If equipped

■ Door lock (→P.105, 109, 328)

Function	Default setting	Customized setting	A	B	C
Unlocking using a mechanical key	All doors unlocked in one step	Driver's door unlocked in one step, all doors unlocked in two step	—	—	○
Locking/unlocking of the trunk when all doors are locked/unlocked	On	Off	—	—	○

■ Smart entry & start system and wireless remote control (→P.105, 111)

Function	Default setting	Customized setting	A	B	C
Operating signal (Buzzers)	5	Off	○	—	○
		1 to 7	—	—	○
Operation signal (Emergency flashers)	On	Off	○	—	○
Time elapsed before automatic door lock function is activated if door is not opened after being unlocked	30 seconds	60 seconds	—	—	○
		120 seconds	—	—	○
Open door warning buzzer	On	Off	—	—	○

■ Smart entry & start system (→P.105, 111)

Function	Default setting	Customized setting	A	B	C
Smart entry & start system	On	Off	○	—	○
Smart door unlocking	All the doors	Driver's door	○	—	○

Function	Default setting	Customized setting	A	B	C
Time elapsed before unlocking all the door when gripping and holding the driver's door handle	2.0 seconds	Off			
		1.5 seconds	—	—	○
		2.5 seconds			
Number of consecutive door lock operations	2 times	As many as desired	—	—	○
Power switch illumination	On	Off	—	—	○

■ **Wireless remote control (→P.103, 105, 109)**

Function	Default setting	Customized setting	A	B	C
Wireless remote control	On	Off	—	—	○
Unlocking operation	All doors unlocked in one step	Driver's door unlocked in one step, all doors unlocked in two step	○	—	○
Trunk unlocking operation	Press and hold (short)	One short press			
		Push twice			
		Press and hold (long)	—	—	○
		Off			

■ **Power switch (→P.140)**

Function	Customized setting	A	B	C
ACC customization Enabling/Disabling ACC mode	On, Off	○	—	—

■ **Power windows and moon roof* (→P.125, 127)**

Function	Default setting	Customized setting	A	B	C
Mechanical key linked operation	Off	On	—	—	○

Function	Default setting	Customized setting	A	B	C
Wireless remote control linked operation	Off	On	—	—	O
Wireless remote control linked operation signal (buzzer)	On	Off	—	—	O

*: If equipped

■ **Moon roof*** (→P.127)

Function	Default setting	Customized setting	A	B	C
Linked operation of components when key is used	Slide only	Tilt only	—	—	O
Linked operation of components when wireless remote control is used	Slide only	Tilt only	—	—	O

*: If equipped

■ **Automatic light control system (→P.154)**

Function	Default setting	Customized setting	A	B	C
Light sensor sensitivity	Standard	-2 to 2	O	—	O
Time elapsed before headlights automatically turn off after doors are closed	30 seconds	Off	O	—	O
		60 seconds			
		90 seconds			

■ **PCS (Pre-Collision System) (→P.171)**

Function	Customized setting	A	B	C
PCS (Pre-Collision System)* ¹	On, Off	—	O	—
Adjust alert timing* ²	Later, Default, Earlier	—	O	—

*¹: The system is automatically enabled each time the power switch is turned to ON.

*²: This setting changes in accordance with My Settings

■ **LDA (Lane Departure Alert) (→186)**

Function	Customized setting	A	B	C
LDA (Lane Departure Alert) system*	On, Off	—	○	—
Alert timing*	Default, Earlier	—	○	—
Alert options*	Vibration, Beep	—	○	—

*: This setting changes in accordance with My Settings

■ **Dynamic radar cruise control (→P.195)**

Function	Customized setting	A	B	C
Acceleration setting* ¹	High, Mid, Low	—	○	—
Speed setting (short press)* ¹	1 km/h, 5 km/h, 10 km/h* ²	—	○	—
	1 mph, 5 mph, 10 mph* ³			
Speed setting (long press)* ¹	1 km/h, 5 km/h, 10 km/h* ²	—	○	—
	1 mph, 5 mph, 10 mph* ³			
Dynamic Radar Cruise Control with Road Sign Assist	On, Off	—	○	—
Speed limit offset	-5 to +5	—	○	—
Guide message* ¹	On, Off	—	○	—
Curve speed reduction* ¹	High, Mid, Low, Off	—	○	—

*¹: This setting changes in accordance with My Settings

*²: When the set speed is shown in “km/h”

*³: When the set speed is shown in “MPH”

■ **RSA (Road Sign Assist) (→P.193)**

Function	Customized setting	A	B	C
RSA (Road Sign Assist)*	On, Off	—	○	—

Function	Customized setting	A	B	C
Excess speed notification method*	None, Visual, Visual and Audible	—	<input type="radio"/>	—
Excess speed notification level*	5 km/h (3 mph), 3 km/h (2 mph), 1 km/h (1 mph)	—	<input type="radio"/>	—

*: This setting changes in accordance with My Settings

■ Driver break suggestion (→P.186)

Function	Customized setting	A	B	C
Driver break suggestion	On, Off	—	<input type="radio"/>	—

■ BSM (Blind Spot Monitor)* (→P.206)

Function	Default setting	Customized setting	A	B	C
BSM (Blind Spot Monitor)	On	Off	—	<input type="radio"/>	—
Outside rear view mirror indicator brightness	Bright	Dim	—	<input type="radio"/>	—
Alert timing for presence of approaching vehicle (sensitivity)	Intermediate	Early	—	<input type="radio"/>	—
		Late			

*: If equipped

■ RCTA (Rear Cross Traffic Alert) function* (→P.211)

Function	Default setting	Customized setting	A	B	C
RCTA (Rear Cross Traffic Alert)	On	Off	—	<input type="radio"/>	—
Buzzer volume	Level 2	Level 1	—	<input type="radio"/>	—
		Level 3			

*: If equipped

■ Safe Exit Assist* (→P.216)

Function	Default setting	Customized setting	A	B	C
Safe Exit Assist	On	Off	—	○	—
Outside rearview mirrors display	On	Off	—	○	—
Detection sensitivity	Middle	High	—	○	—
		Low			

*: If equipped

■ Automatic air conditioning system (→P.232)

Function	Default setting	Customized setting	A	B	C
Switching between outside air and recirculated air mode linked to automatic mode switch operation	On	Off	○	—	○
A/C auto switch operation	On	Off	○	—	○

■ Illumination (→P.238)

Function	Default setting	Customized setting	A	B	C
Time elapsed before the interior lights turn off	15 seconds	Off	○	—	○
		7.5 seconds			
		30 seconds			
Operation after the power switch is turned off	On	Off	—	—	○
Operation when the doors are unlocked	On	Off	—	—	○
Operation when you approach the vehicle with the electronic key on your person	On	Off	—	—	○
Cup holder lights* and center tray light*	On	Off	—	—	○
Door trim lights*	On	Off	—	—	○

*: If equipped

■ Vehicle customization

- When the smart entry & start system is off, smart door unlocking cannot be customized.
 - When the doors remain closed after unlocking the doors and the automatic door lock function is activated, the signals will be generated in accordance with the operation signal (buzzer) and the operation signal (emergency flashers) settings.
- In the following situations, customize mode in which the settings can be changed through the multi-information display will automatically be turned off**
- The power switch is turned off.
 - The vehicle begins to move while the customize mode screen is displayed.

Index

What to do if... (Troubleshooting)	358
Alphabetical Index	361

What to do if... (Troubleshooting)

If you have a problem, check the following before contacting your Toyota dealer.

The doors cannot be locked, unlocked, opened or closed



You lose your keys

- If you lose your mechanical keys, new genuine mechanical keys can be made by your Toyota dealer. (→P.327)
- If you lose your electronic keys, the risk of vehicle theft increases significantly. Contact your Toyota dealer immediately. (→P.327)



The doors cannot be locked or unlocked

- Is the electronic key battery weak or depleted? (→P.281)
- Is the power switch in ON?

When locking the doors, turn the power switch off. (→P.141)

- Is the electronic key left inside the vehicle?

When locking the doors, make sure that you have the electronic key on your person.

- The function may not operate properly due to the condition of the radio wave. (→P.113)



The rear door cannot be opened

- Is the child-protector lock set?

The rear door cannot be opened from inside the vehicle when the lock is set. Open the rear door from outside and then unlock the child-protector lock. (→P.108)



The trunk lid is closed with the electronic key left inside

- The function to prevent the electronic key from being left inside the trunk will operate and you can open the trunk as usual. Take the key out from the trunk. (→P.110)

If you think something is wrong



The hybrid system does not start

- Did you press the power switch while firmly depressing the brake pedal? (→P.140)
- Is the shift lever in P? (→P.140)
- Is the electronic key anywhere detectable inside the vehicle? (→P.112)
- Is the electronic key battery weak or depleted?

In this case, the hybrid system can be

started in a temporary way. (→P.329)

- Is the 12-volt battery discharged? (→P.330)



The shift lever cannot be shifted from P even if you depress the brake pedal

- Is the power switch in ON?

If you cannot release the shift lever by depressing the brake pedal with the power switch in ON. (→P.147)



The windows do not open or close by operating the power window switches

- Is the window lock switch pressed?

The power window except for the one at the driver's seat cannot be operated if the window lock switch is pressed. (→P.127)



The power switch is turned off automatically

- The auto power off function will be operated if the vehicle is left in ACC or ON (the hybrid system is not operating) for a period of time. (→P.142)



A warning buzzer sounds during driving

- The seat belt reminder light is flashing

Are the driver and the passenger wearing the seat belts? (→P.301)

- The parking brake indicator is on

Is the parking brake released? (→P.149)

Depending on the situation, other types of warning buzzer may also sound. (→P.298, 305)



A warning buzzer sounds when leaving the vehicle

- Is the electronic key left inside the vehicle?

Check the message on the multi-information display. (→P.305)



A warning light turns on or a warning message is displayed

- When a warning light turns on or a warning message is displayed, refer to P.298, 305.

When a problem has occurred



If you have a flat tire

- Vehicles with an emergency tire puncture repair kit: Stop the vehicle in a safe place and repair the flat tire temporarily with the emergency tire puncture repair kit. (→P.309)
- Vehicles with a spare tire: Stop the vehicle in a safe place and replace the flat tire with the spare tire. (→P.319)

- Stop the vehicle in a safe place and replace the flat tire with the spare tire. (→P.319)



The vehicle becomes stuck

- Try the procedure for when the vehicle becomes stuck in mud, dirt, or snow. (→P.336)

Alphabetical Index

A

A/C
 Air conditioning filter.....276
 Automatic air conditioning system
232

ABS (Anti-lock Brake System)221
 Warning light300

ACA (Active Cornering Assist)....222
Active Cornering Assist (ACA)....222

AHB (Automatic High Beam).....156

Air conditioning filter276

Air conditioning system
 Air conditioning filter.....276
 Automatic air conditioning system
232

Airbags
 Airbag operating conditions31
 Airbag precautions for your child .33
 Correct driving posture.....23
 Curtain shield airbag operating con-
 ditions31
 Curtain shield airbag precautions 33
 General airbag precautions.....33
 Locations of airbags.....29
 Modification and disposal of airbags
36
 Side airbag operating conditions..31
 Side airbag precautions33
 Side and curtain shield airbags oper-
 ating conditions.....31
 Side and curtain shield airbags pre-
 cautions33
 SRS airbags.....29
 SRS warning light299

Alarm
 Warning buzzer298

Anchor fittings47

**Antennas (smart entry & start sys-
 tem).....111**

Anti-lock Brake System (ABS)221
 Warning light300

Approach warning201

Armrest.....251

Assist grips252

Audio system-linked display ...84, 91

**Automatic air conditioning system
232**

Automatic High Beam156

Automatic light control system...154

Average fuel economy81, 89

Average vehicle speed84

B

Back-up light
 Replacing light bulbs287
 Wattage344

Battery (12-volt battery)
 Battery checking.....269
 If the 12-volt battery is discharged
330
 Preparing and checking before win-
 ter228
 Replacing331
 Warning light299

Battery (traction battery).....61

Blind Spot Monitor (BSM)206

Bottle holders.....241

Brake
 Brake hold152
 Fluid342
 Parking brake149
 Regenerative braking.....59
 Warning light298

Brake assist.....221

Break-in tips133

Brightness control
 Meter light control.....74, 79

BSM (Blind Spot Monitor)206

C

Care
 Exterior254
 Interior257
 Seat belts257
 Wheels and wheel ornaments...254

Chains.....229

Child restraint system
 Points to remember..... 39
 Riding with children..... 38

Child safety
 12-volt battery precautions.270, 332
 Airbag precautions..... 33
 Child restraint system 39
 How your child should wear the seat
 belt.....26
 Installing child restraints..... 39
 Moon roof precautions 129
 Power window lock switch 127
 Power window precautions 126
 Rear door child-protectors 108
 Seat belt precautions 38
 Seat heater precautions.....236
 Trunk precautions 109

Child-protectors..... 108

Cleaning 254, 257
 Exterior..... 254
 Interior..... 257
 Seat belts 257
 Wheels and wheel ornaments....254

Clock..... 72, 74, 75, 80

Coat hooks 252

Condenser..... 269

Console box..... 242

Continuously variable transmission
 If the shift lever cannot be shifted
 from P 147

Cooling system..... 268
 Engine overheating..... 333
 Hybrid system overheating 334

Cruise control 204

Cup holders 241

Current fuel consumption..... 81, 89

Curtain shield airbags..... 29

Customizable features 346

D

Daytime running light system 154

Defogger
 Outside rear view mirrors..... 233
 Rear window 233

Windshield.....233

Dimensions 338

Display
 Cruise control204
 Dynamic radar cruise control 198
 Energy monitor.....97
 Head-up display 93
 Multi-information display 80, 86
 RCTA.....211
 Warning message305

Display change button 74

Do-it-yourself maintenance 260

Door lock
 Doors..... 105
 Smart entry & start system..... 111
 Wireless remote control 103

Doors
 Door glasses 125
 Door lock..... 105
 Open door warning buzzer. 106, 108
 Outside rear view mirrors 123
 Rear door child-protectors..... 108
 Side doors 105

Drive distance 84

Drive information 84

Drive-Start Control (DSC)..... 132

Driving
 Break-in tips 133
 Correct driving posture.....23
 Driving mode select switch.....220
 Hybrid vehicle driving tips 226
 Procedures..... 132
 Winter drive tips228

Driving information display 81

Driving range..... 81, 89

**Driving support system information
 display 84, 88, 91**

DSC (Drive-Start Control)..... 132

Dynamic radar cruise control 195

E

ECO Accelerator Guidance..... 82, 90

Eco score..... 82, 90

EDR (Event data recorder)..... 7

Elapsed time 84

Electric motor (traction motor)..... 58

Electric Power Steering (EPS)..... 222

 Warning light 300

Electronic key 102

 Battery-saving function 112

 If the electronic key does not operate properly 328

 Replacing the battery 281

Emergency brake signal 222

Emergency Driving Stop System 191

Emergency flashers

 Emergency brake signal 222

Emergency tire puncture 309

Emergency, in case of

 If a warning buzzer sounds 298

 If a warning light turns on 298

 If a warning message is displayed 305

 If the 12-volt battery is discharged 330

 If the electronic key does not operate properly 328

 If the hybrid system will not start 326

 If the vehicle is submerged or water on the road is rising 291

 If you have a flat tire..... 309, 319

 If you lose your keys 327

 If you think something is wrong.. 296

 If your vehicle becomes stuck.... 336

 If your vehicle has to be stopped in an emergency 290

 If your vehicle needs to be towed 293

 If your vehicle overheats 333

Energy monitor 97

Engine

 Compartment 266

 Engine switch 140

 Hood 264

 How to start the hybrid system... 140

 Identification number 338

 If the hybrid system will not start 326

 If your vehicle has to be stopped in an emergency 290

 Ignition switch (power switch) 140

 Overheating..... 333

 Power switch 140

 Tachometer 75

Engine coolant

 Capacity 341

 Checking 268

 Preparing and checking before winter 228

Engine coolant temperature gauge 72, 75

Engine oil

 Capacity 339

 Checking 266

 Preparing and checking before winter 228

 Warning light 299

Engine switch (power switch) 140

 If your vehicle has to be stopped in an emergency 290

EPS (Electric Power Steering) 222

 Warning light 300

EV drive mode..... 144

EV Driving Ratio..... 83, 91

EV indicator..... 59

EV Ratio..... 83, 91

Event data recorder (EDR)..... 7

F

Flat tire

 Vehicles with a spare tire 319

 Vehicles with an emergency tire puncture repair kit 309

Floor mats 22

Fluid

 Brake 342

 Hybrid transmission..... 342

 Washer 271

Fog light

 Replacing light bulbs 286

 Switch..... 159

Fog lights..... 159

Front position lights

 Light switch 154

Replacing light bulbs.....	286
Front seats	
Adjustment.....	116
Cleaning.....	257
Correct driving posture.....	23
Head restraints.....	119
Seat heaters.....	236
Front turn signal lights	
Replacing light bulbs.....	286
Turn signal lever	148
Fuel	
Capacity.....	339
Fuel gauge.....	72, 75
Information.....	345
Refueling.....	163
Type.....	339
Warning light.....	300
Fuel consumption	
Average fuel economy	81, 89
Current fuel consumption.....	81, 89
Fuel economy	81, 89
Fuel filler door	
Refueling.....	163
Fuel gauge	72, 75
Fuses	283

G

Gauges	72, 75
Glove box	241
Glove box light	241

H

Head restraints	119
Headlights	
AHB (Automatic High Beam)	156
Light switch	154
Headlights/daytime running lights	
Replacing light bulbs.....	286
Head-up display.....	93
Driving information display area...	93
Driving support system display area	95
Hybrid System Indicator.....	96

Navigation system-linked display	93
Pop-up display	95
Settings	94
Heaters	
Automatic air conditioning system	232
Outside rear view mirrors	233
Seat heaters.....	236
High mounted stoplight	
Replacing light bulbs	286
High-voltage components.....	61
Hill-start assist control.....	222
Hood	
Open	264
Hooks	
Coat hooks.....	252
Retaining hooks (floor mat)	22
Horn	121
Hybrid battery (traction battery)	
Location.....	61
Specification.....	339
Warning message	64
Hybrid battery (traction battery) air intake vent.....	278
Hybrid battery (traction battery) air vents	64
Hybrid system.....	58
Emergency shut off system.....	64
Energy monitor/consumption screen	97
EV drive mode.....	144
High voltage components.....	61
Hybrid system precautions.....	61
If the hybrid system will not start.....	326
Overheating.....	334
Power (ignition) switch	140
Regenerative braking.....	59
Starting the hybrid system.....	140
Hybrid System Indicator	72, 78, 96
Hybrid transmission	146
Hybrid vehicle driving tips.....	226

I

Identification

- Engine 338
- Vehicle 338

Ignition switch (power switch) 140

- Auto power off function 142
- Changing the power switch modes 142
- If your vehicle has to be stopped in an emergency 290

Illuminated entry system 239

Immobilizer system 66

Indicators 70

Initialization

- Power windows 125

Inside rear view mirror 122

Interior lights 238

- Front interior light 238
- Rear interior light 238
- Wattage 344

J

Jack

- Positioning a floor jack 265
- Vehicle-equipped jack 310, 320

Jack handle 310, 320

Jam protection function

- Moon roof 128
- Power windows 125

K

Keyless entry

- Smart entry & start system 111
- Wireless remote control 103

Keys

- Battery-saving function 112
- Electronic key 102
- If the electronic key does not operate properly 328
- If you lose your keys 327
- Key number plate 102
- Keyless entry 105, 111

- Mechanical key 102
- Power switch 140
- Replacing the battery 281
- Warning buzzer 112
- Wireless remote control 103

Knee airbags 29

L

Lane Departure Alert (LDA) 186

Lane Tracing Assist (LTA) 181

- Operation 181

Language (multi-information display) 85, 92

LDA (Lane Departure Alert) 186

- Operation 186

Lever

- Auxiliary catch lever 264
- Hood lock release lever 264
- Internal trunk release lever 111
- Shift lever 146
- Turn signal lever 148
- Wiper lever 160

License plate lights

- Light switch 154
- Replacing light bulbs 286

Light bulbs

- Replacing 285

Lights

- AHB (Automatic High Beam) 156
- Front interior lights 238
- Headlight switch 154
- Interior lights 238
- Interior lights list 238
- Personal lights 239
- Rear interior light 238
- Replacing light bulbs 286
- Trunk light 110
- Turn signal lever 148
- Vanity lights 251
- Wattage 344

LTA (Lane Tracing Assist) 181

- Operation 181

LTA (Lane Tracing Assist) switch 183

M

Maintenance

- Do-it-yourself maintenance 262
- Maintenance data 338
- Maintenance requirements 260

Malfunction indicator lamp..... 299**Manual headlight leveling dial..... 155****Menu icons..... 80****Meter**

- Clock 72, 75
- Hybrid System Indicator 72, 78
- Indicators 70
- Meter control switches 81, 87
- Meter light control 74, 79
- Meters 72, 75
- Multi-information display 80, 86
- Settings 85, 92
- Warning lights 298
- Warning message 305

Mirrors

- Inside rear view mirror 122
- Outside rear view mirror defoggers
..... 233
- Outside rear view mirrors 123
- Vanity mirrors 251

Moon roof

- Door lock linked moon roof operation
..... 128
- Jam protection function 128
- Operation 127

Multi-information display

- Audio system-linked display... 84, 91
- Clock 74, 80
- Cruise control 204
- Driving information display 81
- Driving support system information
display 84, 88, 91
- Dynamic radar cruise control 198
- ECO Accelerator Guidance... 82, 90
- Eco score 82, 90
- Energy monitor 97
- EV Driving Ratio 83, 91
- EV Ratio 83, 91
- Fuel economy 81, 89

- Menu icons 80
- Meter control switches 81, 87
- Navigation system-linked display 84,
88, 91
- Settings 85, 92
- Vehicle information display 84
- Warning message 305

N

**Navigation system-linked display 84,
88, 91, 93**

O

“ODO TRIP” switch..... 79**Odometer 74, 79****Odometer and trip meter display**

- Display change button 74
- Display items 74, 79
- “ODO TRIP” switch 79

Oil

- Engine oil 339

Open tray 242**Opener**

- Fuel filler door 163
- Hood 264
- Trunk 110

Outside rear view mirrors

- Adjustment 124
- BSM (Blind Spot Monitor) 206
- Folding 124
- Outside rear view mirror defoggers
..... 233
- RCTA function 211
- Safe Exit Assist 216

Outside temperature..... 72, 75**Overheating..... 333**

P

Parking brake

- Operation 149
- Parking brake engaged warning
buzzer 151

Warning light 303
 Warning message 151
PCS (Pre-Collision System)..... 171
 Function 172
 Warning light 302
Personal lights.....238
 Wattage..... 344
Power control unit.....61
Power control unit coolant
 Capacity 341
 Checking 268
 Preparing and checking before winter 228
Power outlet.....245
Power steering (Electric power steering system).....222
 Warning light 300
Power switch 140
 Auto power off function 142
 Changing the power switch modes 142
Power switch (engine switch)
 If your vehicle has to be stopped in an emergency 290
Power windows
 Door lock linked window operation 126
 Jam protection function 125
 Operation 125
 Window lock switch 127
Pre-Collision System (PCS)..... 171
 Function 172
 Warning light 302

R

Radiator269
RCTA
 Function 211
RCTA function.....212
Rear Cross Traffic Alert (RCTA) .. 211
Rear fog light 159
 Replacing light bulbs 286
 Switch 159

Rear seats..... 117
 Head restraints..... 119
Rear turn signal lights
 Replacing light bulbs 286
 Turn signal lever..... 148
 Wattage 344
Rear view mirror
 Inside rear view mirror..... 122
 Outside rear view mirrors 123
Rear window defogger233
Refueling
 Capacity 339
 Fuel types..... 339
 Opening the fuel tank cap 163
Regenerative braking59
Replacing
 Electronic key battery 281
 Fuses 283
 Light bulbs..... 285
 Tires 319
Road Sign Assist (RSA) 193
RSA (Road Sign Assist) 193

S

Safe Exit Assist.....216
Seat belt reminder light.....301
Seat belts.....25
 Adjusting the seat belt.....27
 Child restraint system installation.39
 Cleaning and maintaining the seat belt 257
 Emergency Locking Retractor 26
 How to wear your seat belt..... 26
 How your child should wear the seat belt 26
 Pregnant women, proper seat belt use 25
 Reminder light and buzzer 301
 Seat belt pretensioners 27
 SRS warning light..... 299
Seat heaters236
Seats
 Adjustment 116
 Adjustment precautions..... 116

Child seats/child restraint system
 installation..... 39
 Cleaning..... 257
 Head restraints..... 119
 Properly sitting in the seat..... 23
 Seat heaters..... 236
Secondary Collision Brake **222**
Sensor
 AHB (Automatic High Beam) 156
 Automatic headlight system 154
 BSM (Blind Spot Monitor) 206
 Inside rear view mirror 123
 Radar sensor 207, 217
 Rain-sensing windshield wipers. 162
 RCTA..... 212
Service plug **61**
Shift lever
 Hybrid transmission 146
Shift lock system **147**
Side airbags **29**
Side mirrors
 Adjustment..... 124
 BSM (Blind Spot Monitor) 206
 Folding 124
 RCTA function 211
Side turn signal lights
 Replacing light bulbs..... 286
 Turn signal lever 148
Side windows..... **125**
Smart entry & start system
 Antenna location 111
 Entry functions 105
 Starting the hybrid system 140
Snow tires **228**
Spare tire..... **319**
 Inflation pressure 343
 Storage location 320
Spark plug..... **341**
Specifications **338**
Speedometer..... **72, 75**
Steering wheel
 Adjustment..... 121
 Meter control switches 81, 87
Stop lights
 Replacing light bulbs..... 286

Storage features **240**
Stuck
 If the vehicle becomes stuck 336
Sun visors **251**
Sunshade
 Roof..... 128
Switches
 AHB (Automatic High Beam)..... 156
 Brake Hold switch 152
 Display change button..... 74
 Door lock switches 108
 Driving mode select switch..... 220
 Dynamic radar cruise control switch
 198
 Emergency flashers switch 290
 EV drive mode switch..... 144
 Ignition switch..... 140
 Light switches..... 154
 LTA (Lane Tracing Assist) switch 183
 Meter control switches 81, 87
 Moon roof switches 127
 “ODO TRIP” switch 79
 Outside rear view mirror switches
 123
 Parking brake switch 149
 Power door lock switch 108
 Power switch 140
 Power window switches 125
 RCTA switch 211
 Rear window and outside rear view
 mirror defoggers switch..... 232
 Seat heater switches..... 236
 “SOS” button 54
 Vehicle-to-vehicle distance switch
 200
 VSC OFF switch..... 222
 Window lock switch 127
 Windshield wiper and washer switch
 160

T

Tachometer..... **75**
Tail lights
 Light switch 154

Replacing light bulbs 286

Theft deterrent system

Immobilizer system 66

Tire inflation pressure 274

Maintenance data 343

Tires

Chains 229

Checking 272

Emergency tire puncture repair kit
..... 309

If you have a flat tire 309, 319

Inflation pressure 274

Replacing 319

Rotating tires 274

Size 343

Snow tires 228

Spare tire 319

Tools 310, 320

Towing

Emergency towing 293

Towing eyelet 295

Trailer towing 139

Toyota Connected Services 54

“SOS” button 54

Toyota Safety Sense

AHB (Automatic High Beam) 156

Cruise control 204

Dynamic radar cruise control 195

Emergency Driving Stop System 191

LDA (Lane Departure Alert) 186

LTA (Lane Tracing Assist) 181

PCS (Pre-Collision System) 171

RSA (Road Sign Assist) 193

Traction battery (hybrid battery)

Hybrid battery (traction battery) air
vents 64

Location 61

Specification 339

Warning message 64

Traction Control (TRC) 222

Traction motor (electric motor) 58

Trailer towing 139

Transmission

Driving mode select switch 220

Hybrid transmission 146

TRC (Traction Control) 222

Trip meters 74, 79

Trunk 109

Internal trunk release lever 111

Smart entry & start system 110

Trunk light 110

Trunk opener 110

Wireless remote control 110

Trunk light 110

Wattage 344

Turn signal lights

Replacing light bulbs 286

Turn signal lever 148

Wattage 344

U

USB charging port 244

V

Vanity lights 251

Wattage 344

Vanity mirrors 251

Vehicle data recording 6

Vehicle identification number 338

Vehicle information display 84

Vehicle Stability Control (VSC) 221

VSC (Vehicle Stability Control) 221

W

Warning buzzers

ABS 300

Airbags 299

Approach warning 201

Brake hold 304

Brake Override System 300

Brake system 298

Charging system 299

Drive-Start Control 300

Electric power steering 300

Engine 299

High coolant temperature 298

Hybrid system 299

- Hybrid system overheat 299
 LDA (Lane Departure Alert) 186, 302
 Low engine oil pressure 299
 LTA (Lane Tracing Assist) .. 181, 302
 Open door 106, 108
 Seat belt 301
- Warning label 61**
- Warning lights 298**
- ABS 300
 Brake hold operated indicator 304
 Brake Override System 300
 Brake system 298
 Charging system 299
 Cruise control indicator 302
 Drive-Start Control 300
 Driving assist information indicator
 303
 Dynamic radar cruise control indica-
 tor 302
 Electric power steering 300
 High coolant temperature 298
 Hybrid system overheat 299
 LDA indicator 302
 Low engine oil pressure 299
 Low fuel level 300
 LTA indicator 302
 Malfunction indicator lamp 299
 Parking brake indicator 303
 Pre-collision system 302
 Seat belt reminder light 301
 Slip indicator 303
 SRS 299
- Warning messages 305**
- Washer**
- Checking 271
 Preparing and checking before win-
 ter 228
 Switch 160
- Washing and waxing 254**
- Wheels 275**
- Replacing 275
 Size 343
- Window lock switch 127**
- Windows**
- Power windows 125
- Rear window defogger 233
 Washer 160
- Windshield wipers 160**
- Winter driving tips 228**
- Wireless charger 245**
- Wireless remote control**
- Battery-Saving Function 112
 Locking/Unlocking 103
 Replacing the battery 281
-
- For information regarding the equipment listed below, refer to “Multimedia Owner’s Manual”.**
- Navigation system
 - Audio/visual system
 - Rear view monitor system
 - Toyota App Suite

Certifications

- ▶ BSM (Blind Spot Monitor)



C3-054

GAS STATION INFORMATION

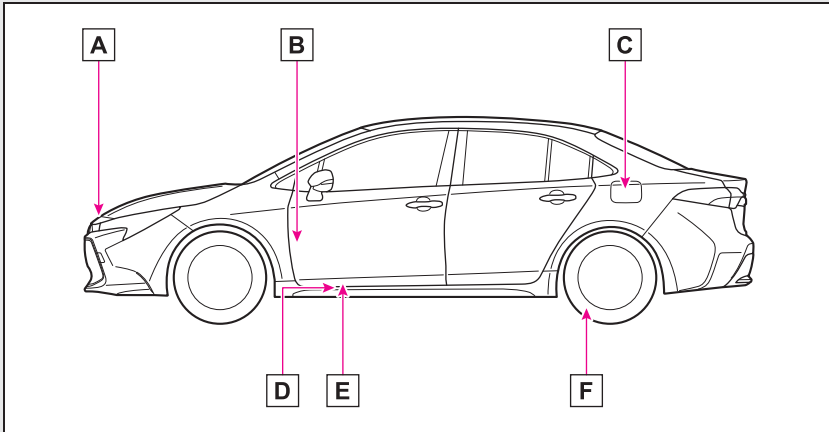

- A** Auxiliary catch lever (→P.264)
- B** Hood lock release lever (→P.264)
- C** Fuel filler door (→P.164)
- D** Trunk opener (→P.110)
- E** Fuel filler door opener (→P.164)
- F** Tire inflation pressure (→P.343)

Fuel tank capacity (Reference)	43.0 L (11.4 gal., 9.5 Imp. gal.)	
Fuel type	Unleaded gasoline only	P.339 P.345
Cold tire inflation pressure		P.343
Engine oil capacity (Drain and refill — reference)		P.339
Engine oil type	“Toyota Genuine Motor Oil” or equivalent	P.339

